

# 2JE20

## CELLULAR / LTE Surface Mount

### Key Features

#### CELLULAR / LTE

- 698-960 MHz
- 1710-2170 MHz
- 2500-2700 MHz

Surface Mount

High Performance

Ceramic Material

Ground Plane Dependent

Dimensions 35 x 5 x 4 mm

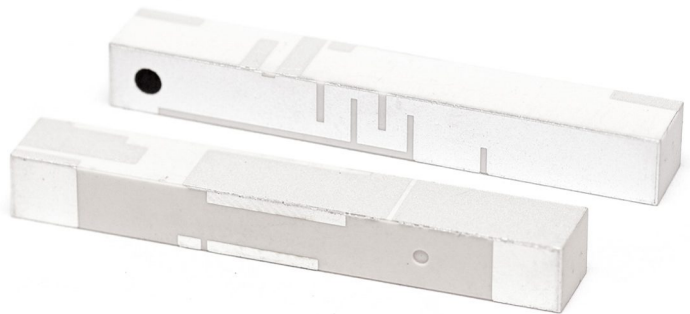

## 1. Antenna and electrical specifications

Parameters	CELLULAR / LTE Antenna		
	2G,3G and 4G		
<b>Standards</b>	2G,3G and 4G		
<b>Band (MHz)</b>	700/850/900	1700/1800/1900/2100	2600
<b>Frequency (MHz)</b>	698-960	1710-2170	2500-2700
<b>Return Loss (dB)</b>	~-6.2	~-6.1	~-15.7
<b>VSWR</b>	~3.0:1	~3.0:1	~1.4:1
<b>Efficiency (%)</b>	~43.1	~53.7	~72.6
<b>Peak Gain (dBi)</b>	~0.3	~3.0	~4.8
<b>Average Gain (dB)</b>	~-3.9	~-2.7	~-1.4
<b>Impedance (Ohm)</b>	50		
<b>Polarisation</b>	Linear		
<b>Radiation Pattern</b>	Omni-Directional		
<b>Max. Input Power (W)</b>	25		

### Antenna Measurement Conditions:

Mounted on ground plane of 107 x 43.4 mm

Measured in Certified CTIA 3D Anechoic Chamber

## 2. Mechanical and environmental specifications

Specifications	2JE20
<b>Mounting Type</b>	Surface Mount
<b>Dimensions (mm)</b>	35 x 5 x 4
<b>Material</b>	Ceramic
<b>Operating Temperature (C)</b>	-40 to +85
<b>Storage Temperature (C)</b>	-40 to +85
<b>Storage Relative Humidity (%)</b>	Up to 93 at 30 C
<b>Substance Compliance</b>	RoHS
<b>Typical Shear Force Test</b>	25 kgf according to IEC62137-1-2:2007

### 3. Antenna parameters

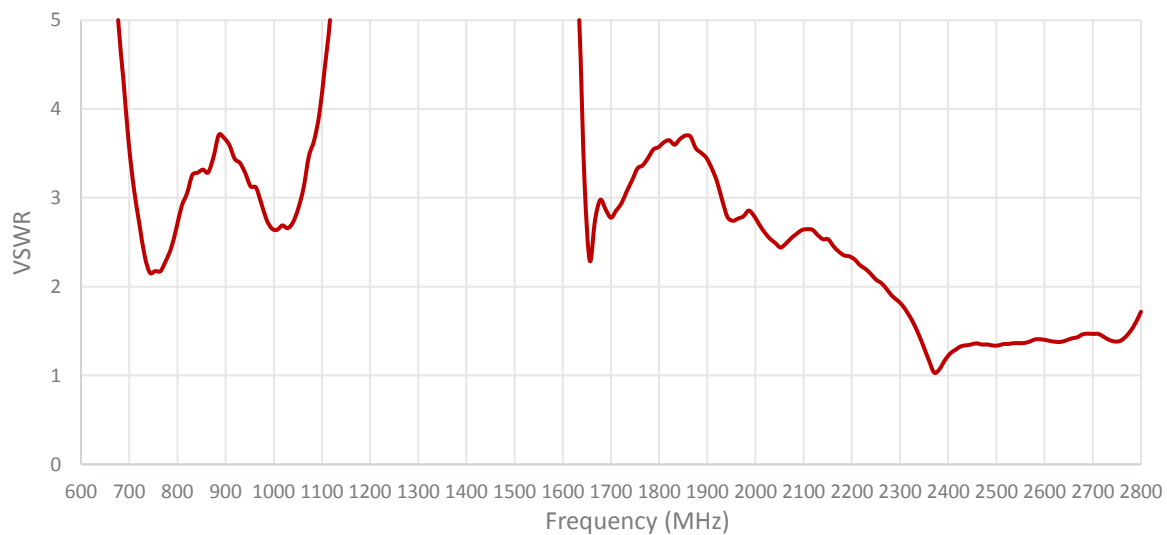
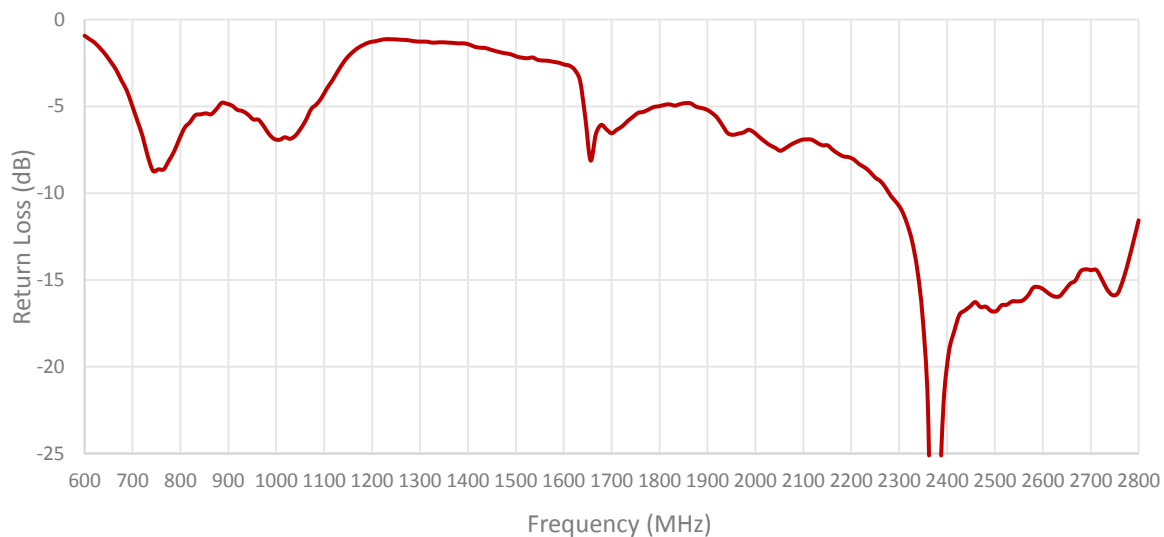

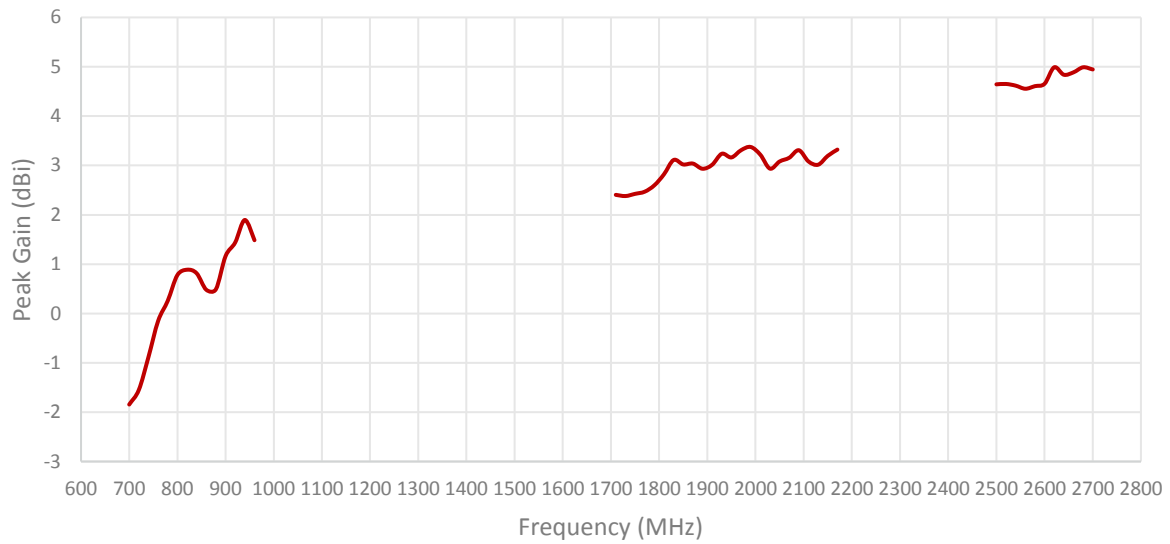
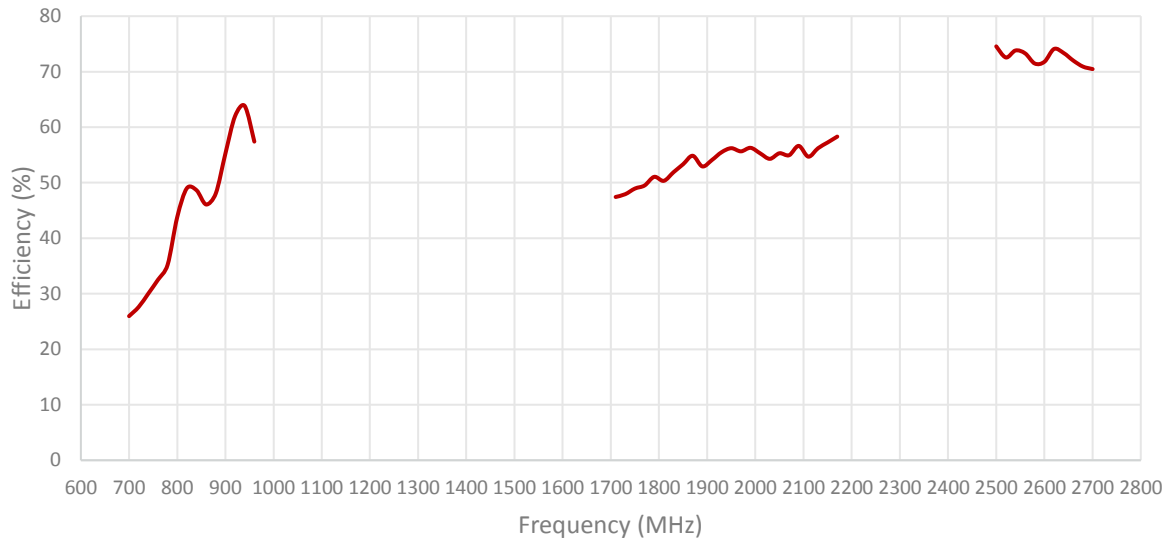

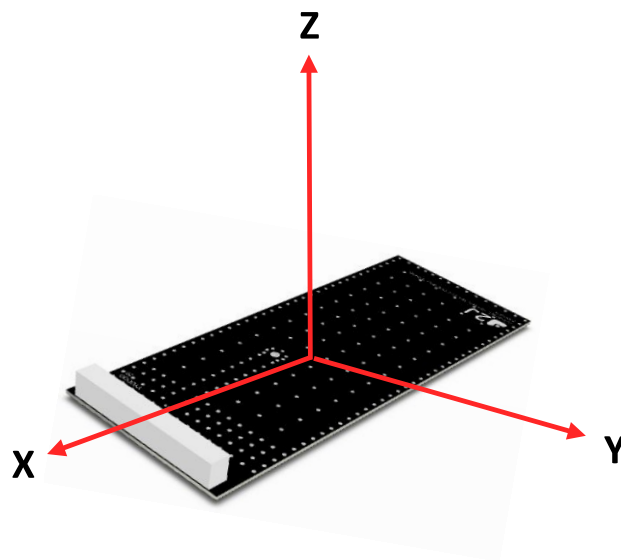
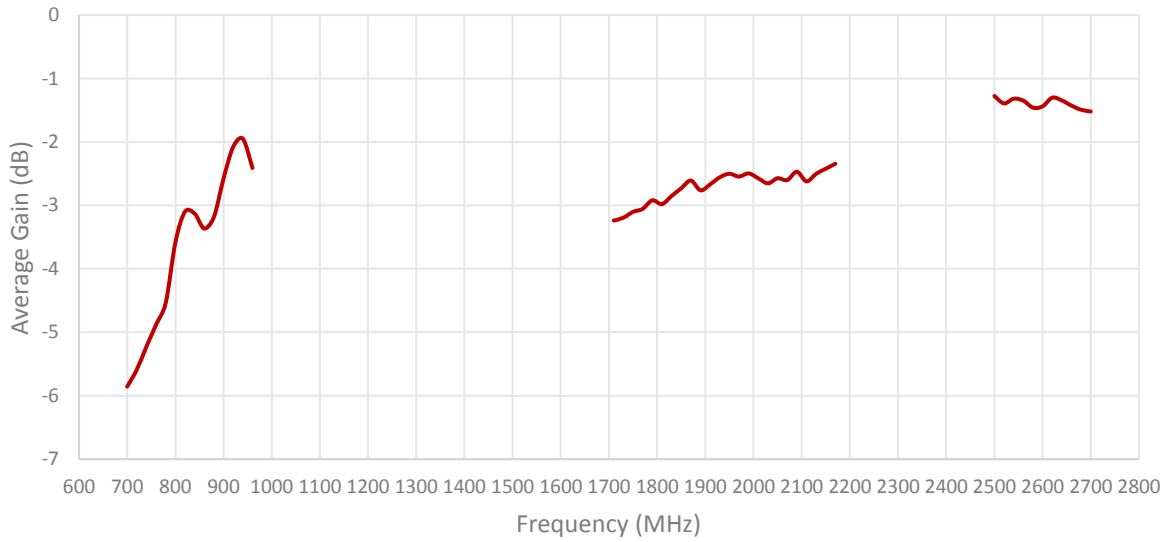

Radiation pattern reference

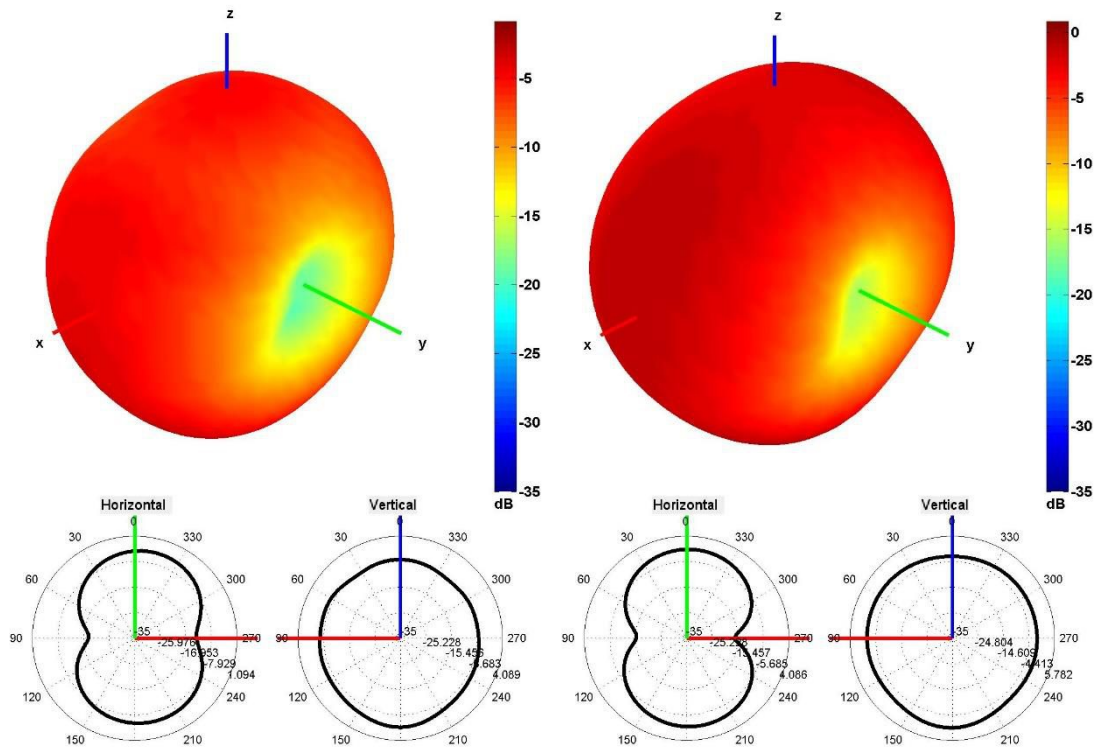

750 and 850 MHz Radiation pattern

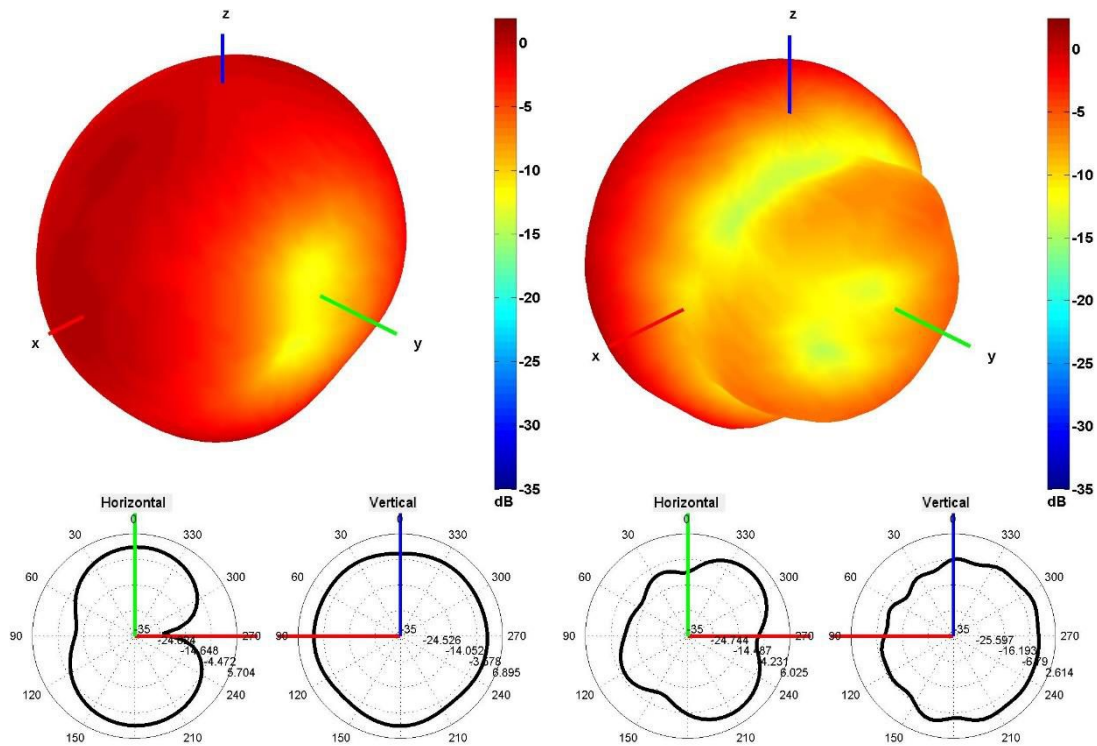

940 and 1750 MHz Radiation pattern

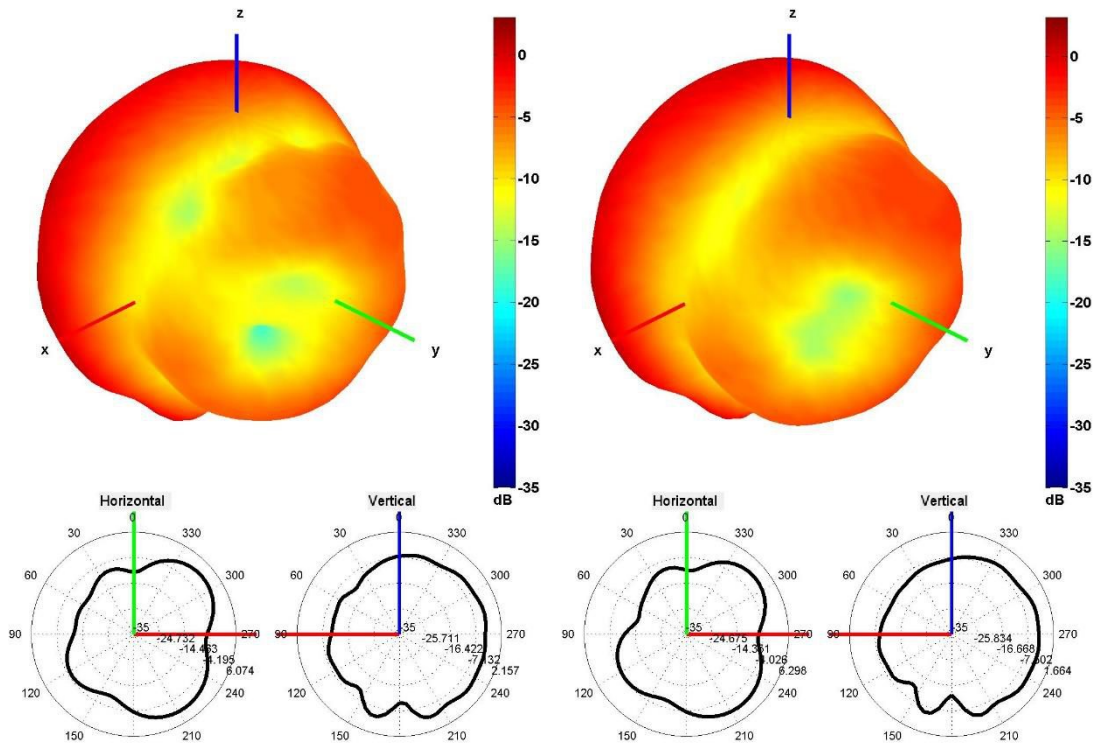

1850 and 1950 MHz Radiation pattern

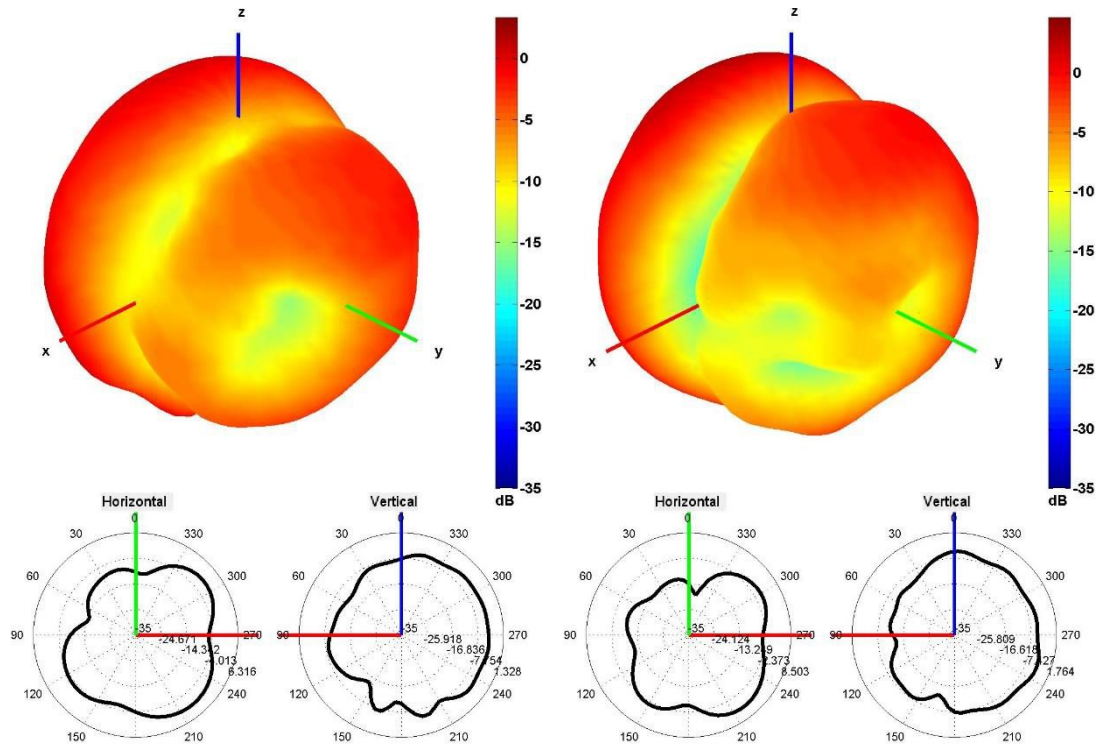

2100 and 2600 MHz Radiation pattern

## 4. PCB Layout

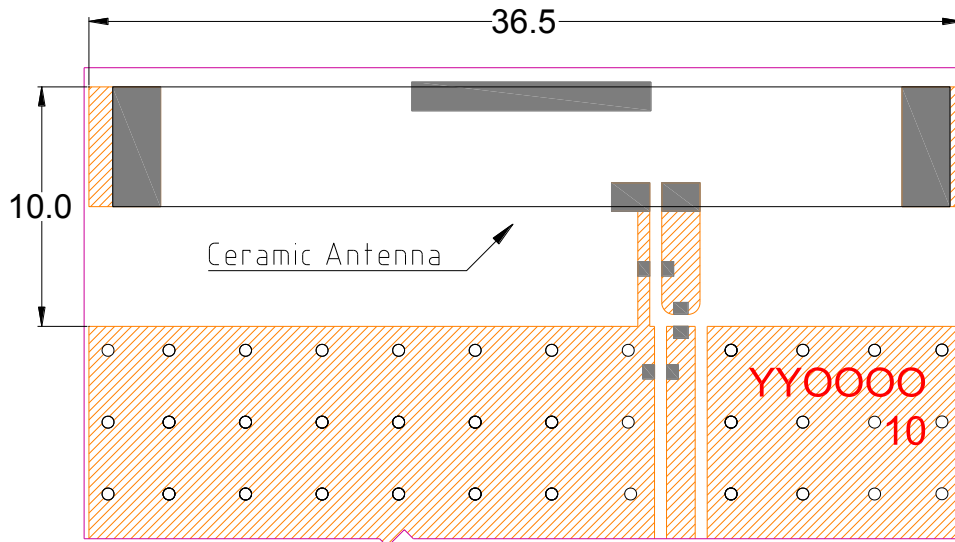

Minimum area required for antenna integration (44.8mm × 10mm)

- Solder Region
- ▨ Copper Region
- Copper-Free Region

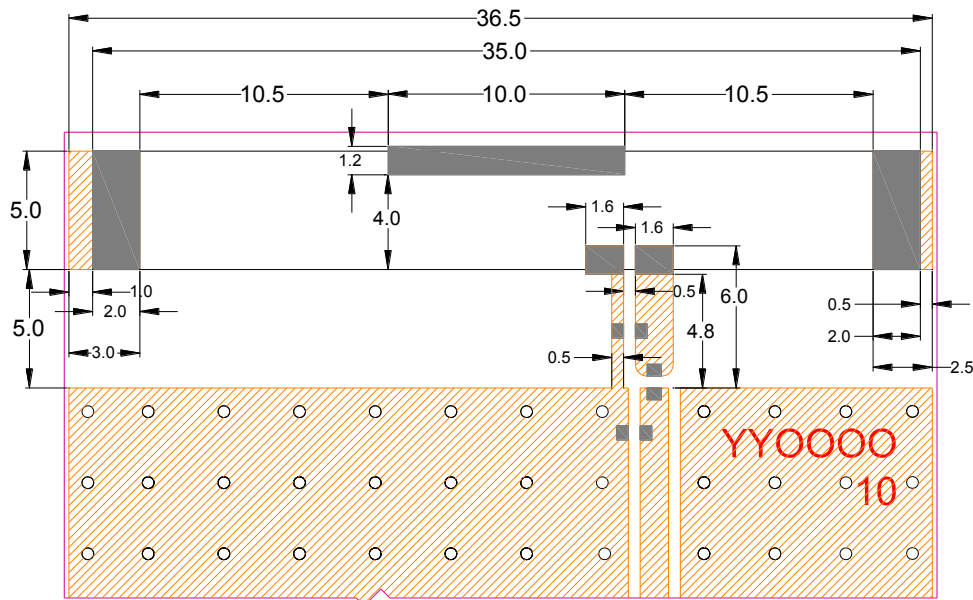

Layout dimensions for antenna integration (mm)

- Solder Region
- ▨ Copper Region
- Copper-Free Region



## 5. Matching Network

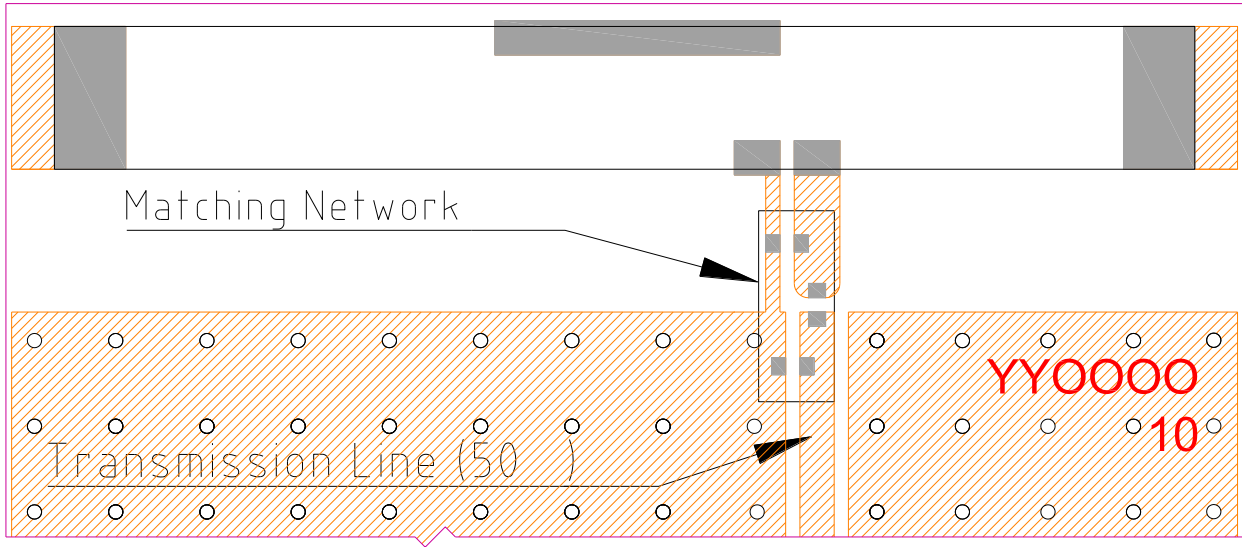

-  Solder Region
-  Copper Region
-  Copper-Free Region

Matching network drawing



3D View of matching components and recommended values

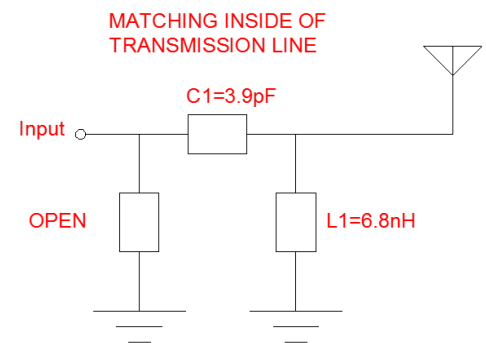

## 6. Evaluation Board

118mm x 36.9mm

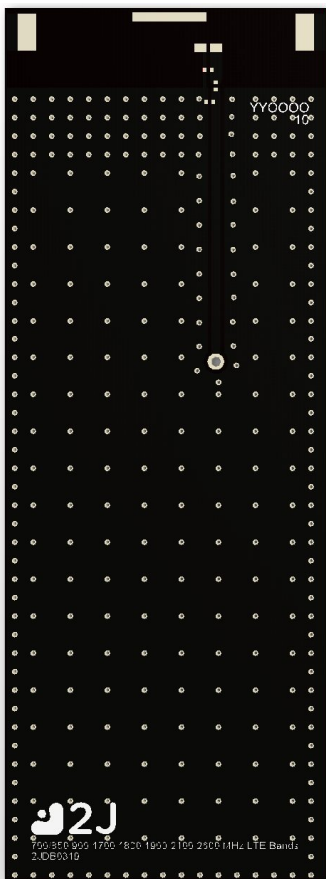

Front View without Antenna

118mm x 36.9mm

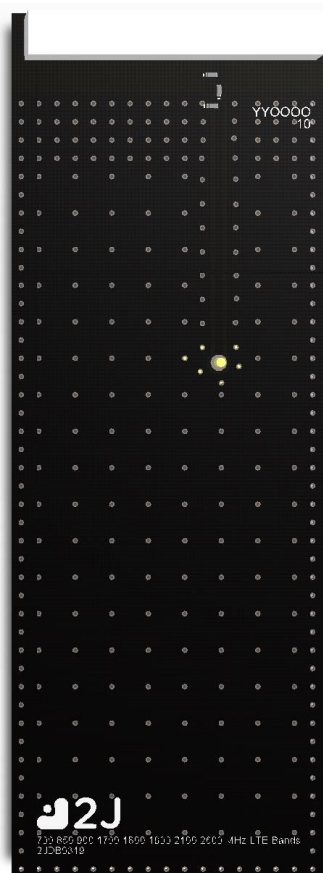

Front View with Antenna

118mm x 36.9mm

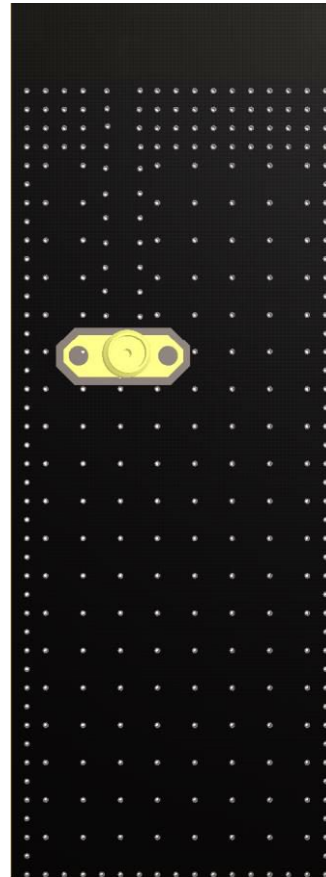

Back View

118mm x 36.9mm  
(PCB: 0.8mm, Antenna: 4mm,  
Connector: 9.5mm)

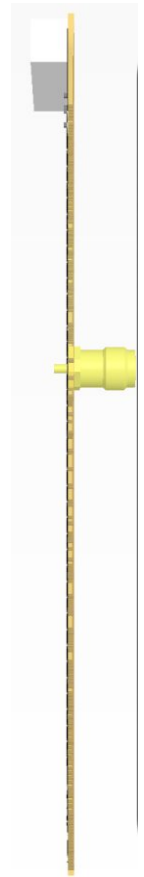

Side View

## 7. Packaging

### PACKAGING SPECIFICATION

<b>Antenna</b>	2JE20
<b>REEL</b>	
<b>Max Quantity per Reel</b>	1000
<b>REEL CARTON</b>	
<b>Reels per Carton</b>	2
<b>Max Quantity per Carton</b>	2000
<b>Reel Carton Dimensions (cm)</b>	34 x 35 x 21
<b>Reel Carton Weight (Kg)</b>	3.6
<b>PALLET</b>	
<b>Max Cartons per Pallet</b>	30
<b>Cartons per Layer</b>	6
<b>Number of Layers</b>	5
<b>Max Quantities per Pallet</b>	60,000
<b>Total Cartons Dimensions (cm)</b>	105 x 68 x 105
<b>Total Cartons Weight (Kg)</b>	108
<b>Pallet size and weight not included above</b>	
<b>Typical Pallet Size (cm)</b>	120 x 100 x 14.4
<b>Typical Pallet Weight (Kg)</b>	5-25

## 8. Tape and Reel Information

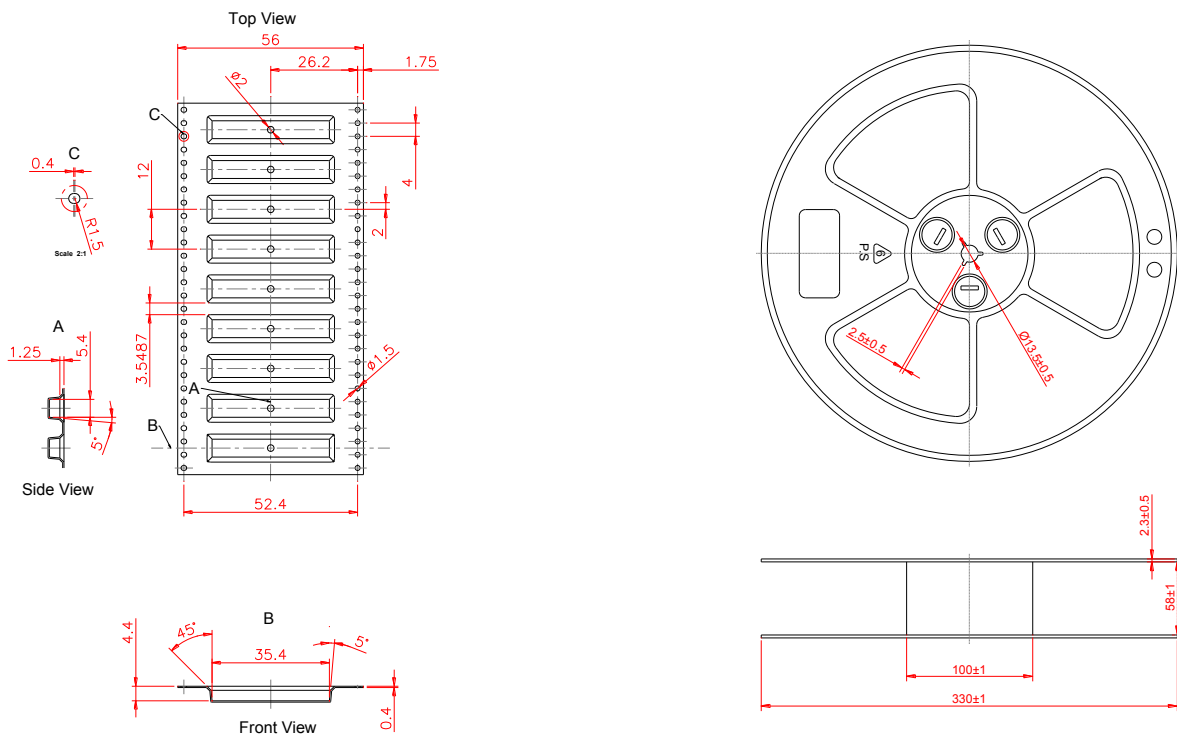

Tape and Reel Specifications

## REFLOW TEMPERATURE PROFILE

Minimum Recommended Reflow Profile

	Method of heat transfer	Controlled hot air convection
1	Average temperature gradient in preheating	2.5 °C/s
2	Soak time	2-3 minutes
3	Max temperature gradient in reflow	3 °C/s
4	Time above 217 °C	Max 30 sec
5	Peak temperature in reflow	230 °C for 10 seconds
6	Temperature gradient in cooling	Max -5 °C/s

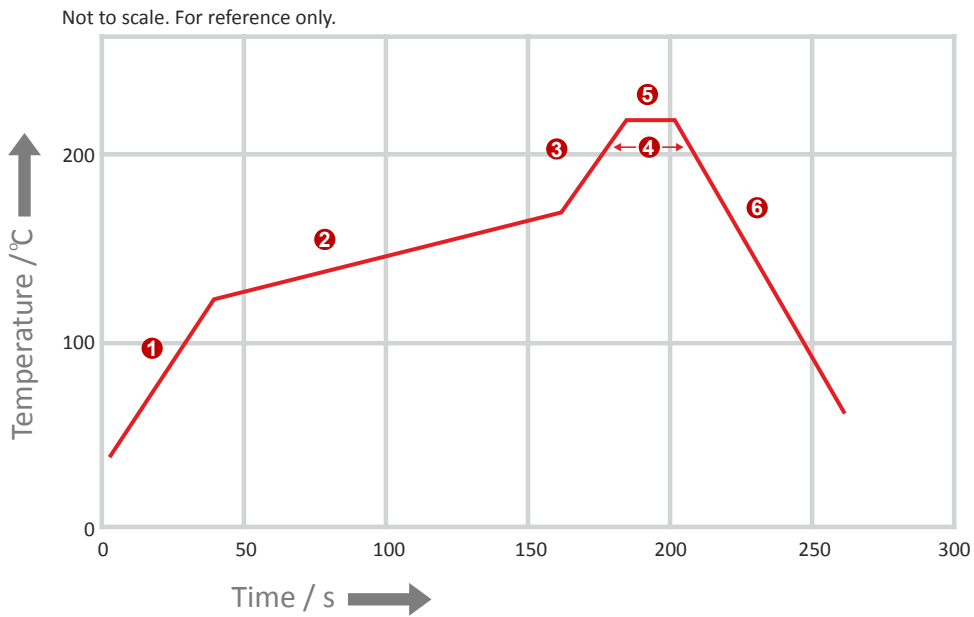

### REFLOW TEMPERATURE PROFILE

Maximum Recommended Reflow Profile

	Method of heat transfer	Controlled hot air convection
1	Average temperature gradient in preheating	2.5 °C/s
2	Soak time	2-3 minutes
3	Max temperature gradient in reflow	3 °C/s
4	Time above 217 °C	Max 60 sec
5	Time above 230 °C	Max 50 sec
6	Time above 250 °C	Max 10 sec
7	Peak temperature in reflow	260 °C for 5 seconds
8	Temperature gradient in cooling	Max -5 °C/s

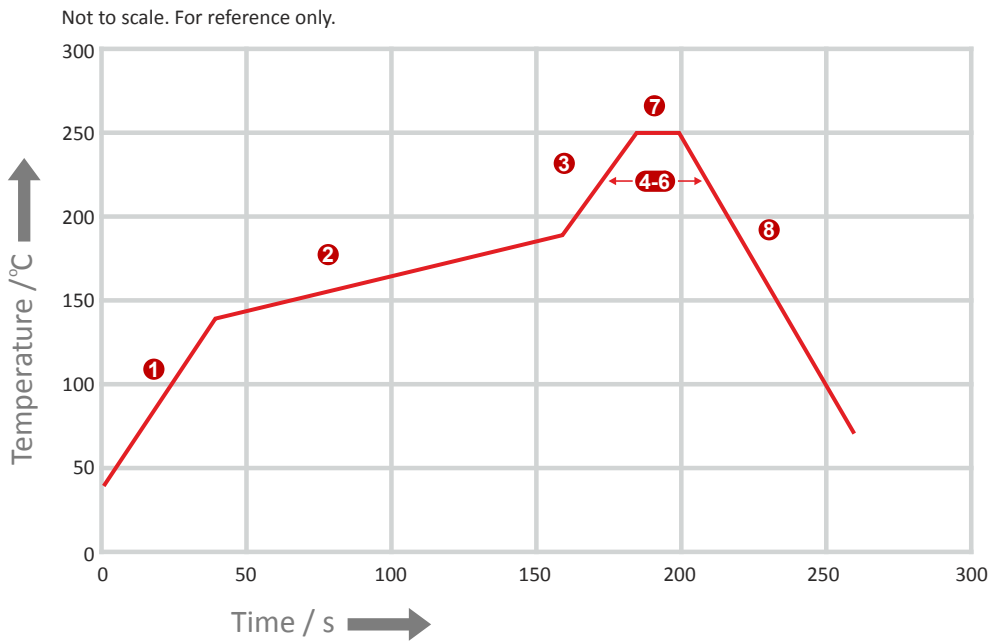

## 9. Antenna drawings

Top View

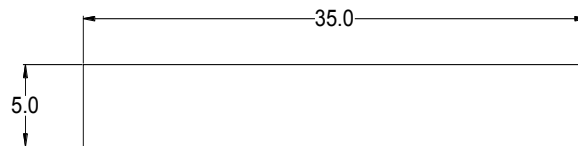

Front View

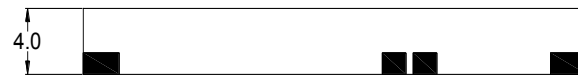

Bottom View



Back View



Dimensions for ceramic antenna 35 x 5 x 4 mm

## 10. Antenna Images

