

2JE19

CELLULAR / LTE Surface Mount

Key Features

CELLULAR / LTE

- 698-960 MHz
- 1710-2170 MHz
- 2500-2700 MHz

Surface Mount

High Performance

Ceramic Material

Ground Plane Dependent

Dimensions 40 x 5 x 6 mm

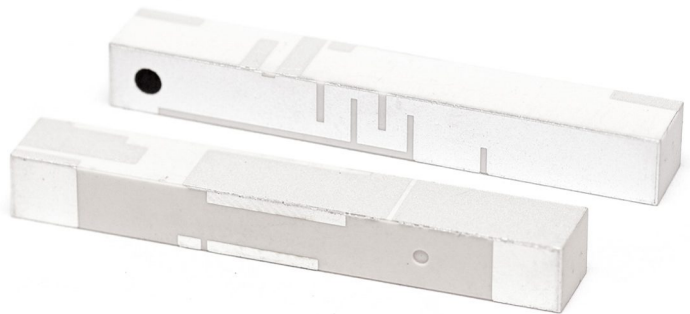

1. Antenna and electrical specifications

Parameters	CELLULAR / LTE Antenna		
Standards	2G,3G and 4G		
Band (MHz)	700/850/900	1700/1800/1900/2100	2600
Frequency (MHz)	698-960	1710-2170	2500-2700
Return Loss (dB)	~-7.2	~-10.3	~-9.5
VSWR	~2.7:1	~2.0:1	~2.1:1
Efficiency (%)	~49.3	~67.1	~59.4
Peak Gain (dBi)	~0.9	~3.9	~-3.6
Average Gain (dB)	~-3.3	~-1.7	~-2.3
Impedance (Ohm)	50		
Polarisation	Linear		
Radiation Pattern	Omni-Directional		
Max. Input Power (W)	25		

Antenna Measurement Conditions:

Mounted on ground plane of 107 x 43.4 mm

Measured in Certified CTIA 3D Anechoic Chamber

2. Mechanical and environmental specifications

Specifications	2JE19
Mounting Type	Surface Mount
Dimensions (mm)	40 x 5 x 6
Material	Ceramic
Operating Temperature (C)	-40 to +85
Storage Temperature (C)	-40 to +85
Storage Relative Humidity (%)	Up to 93 at 30 C
Substance Compliance	RoHS
Typical Shear Force Test	20 kgf according to IEC62137-1-2:2007

3. Antenna parameters

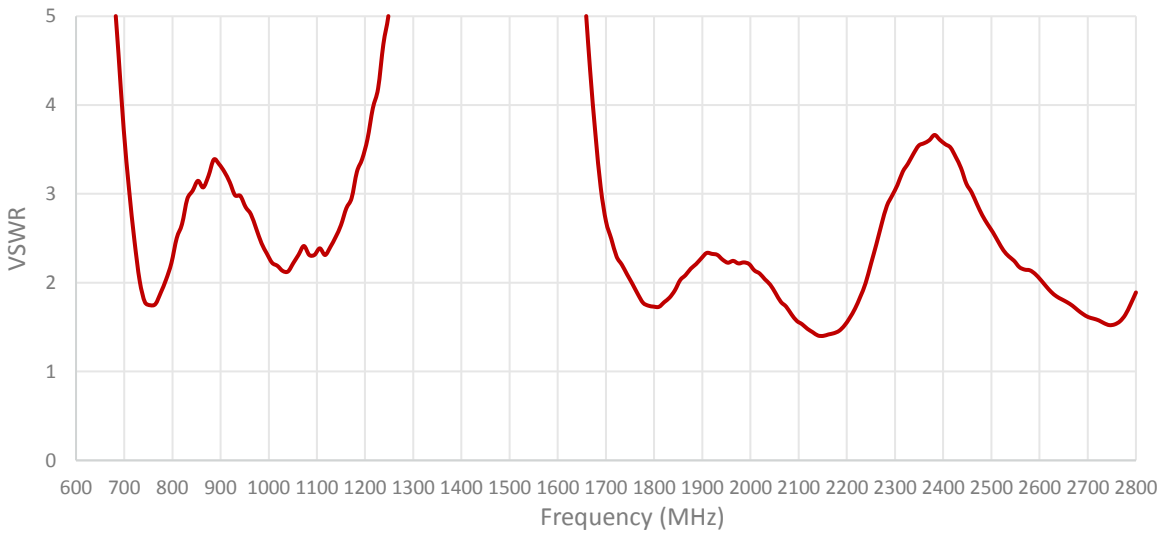
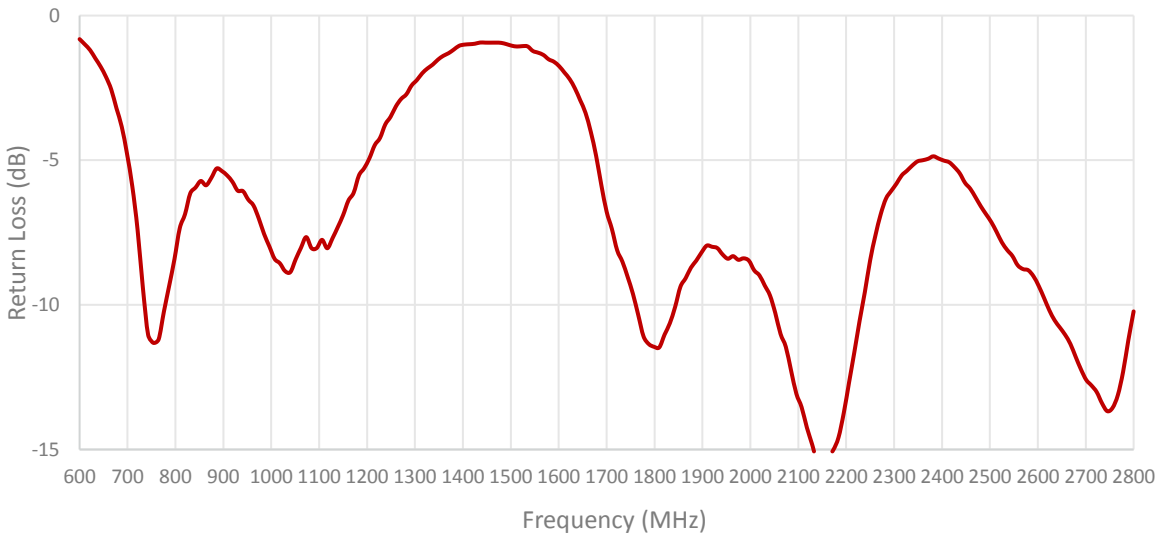

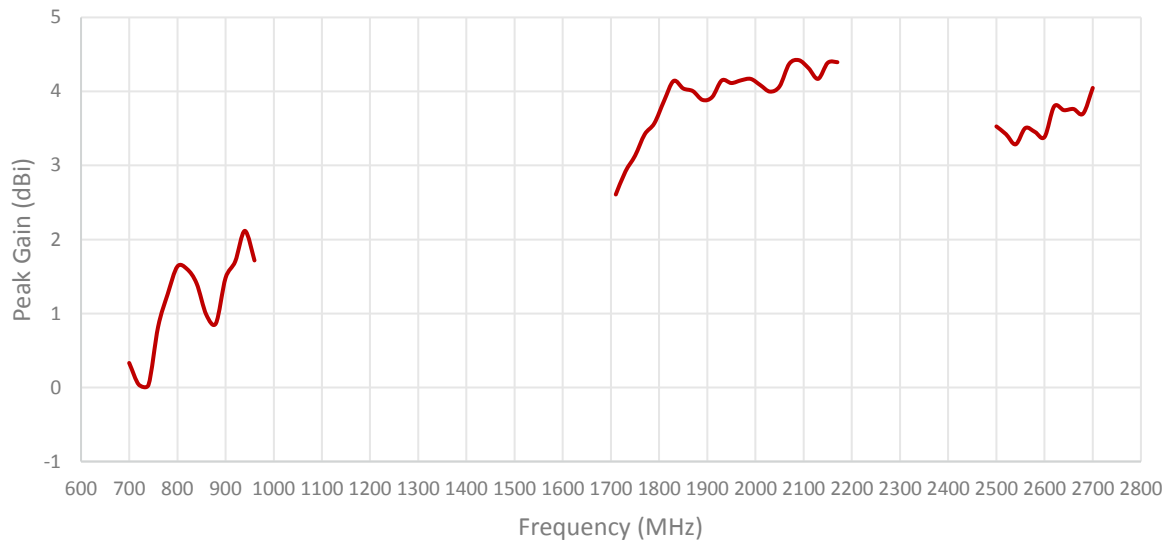
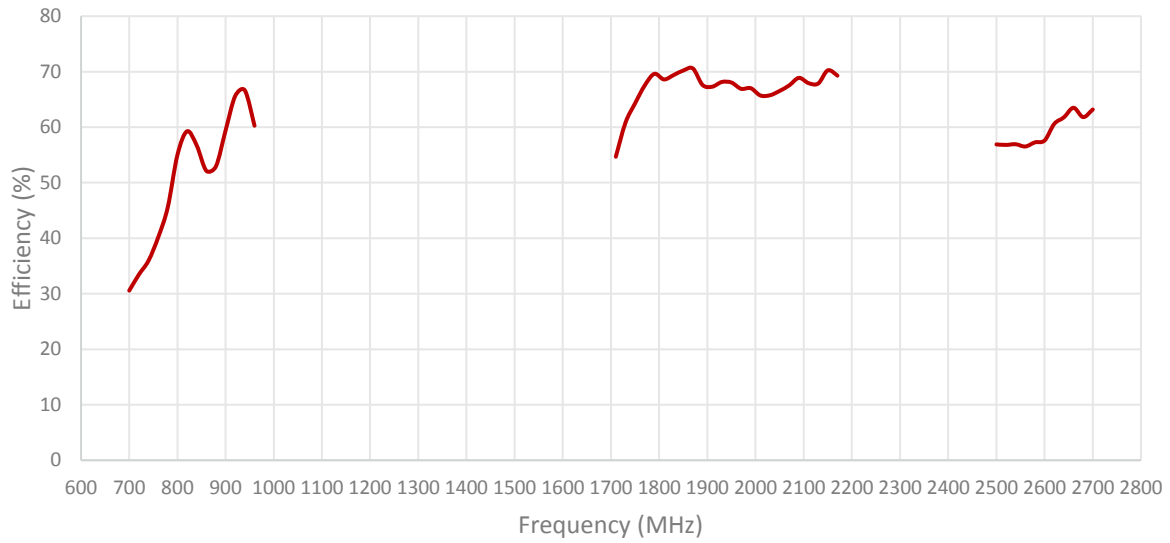

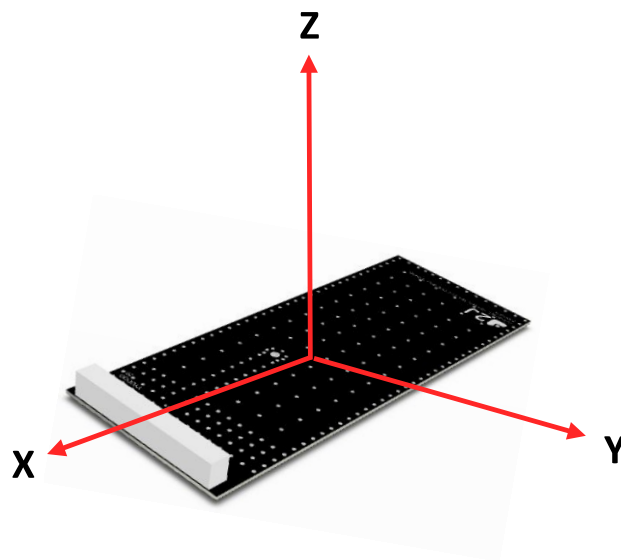
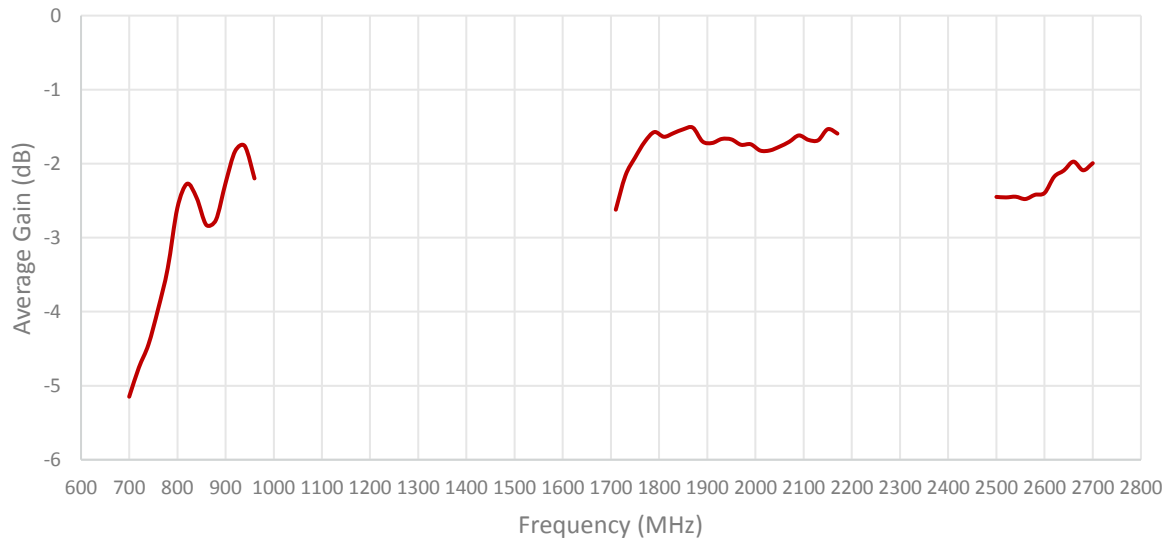

Radiation pattern reference

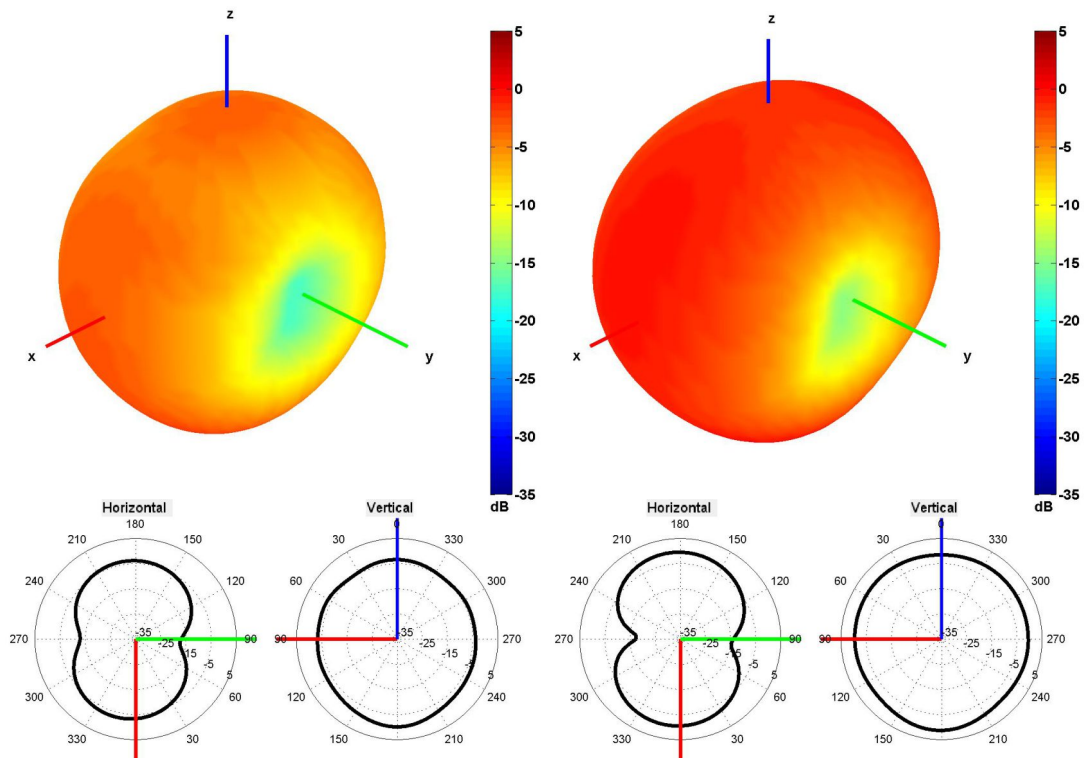

750 and 850 MHz Radiation pattern

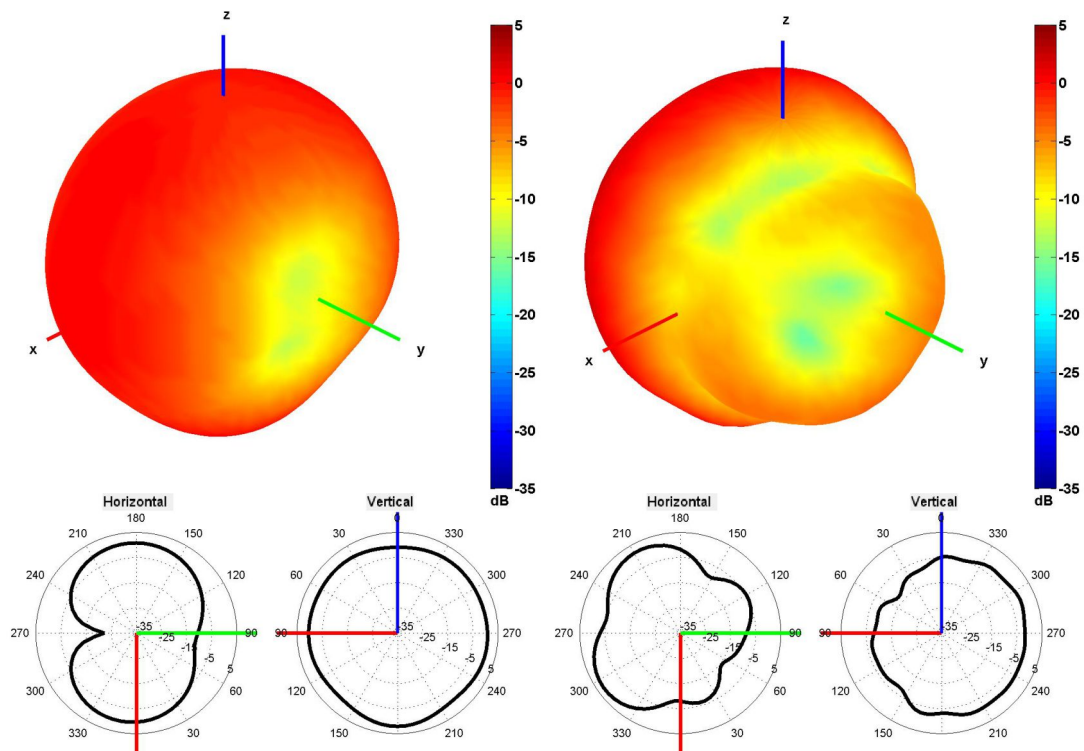

940 and 1750 MHz Radiation pattern

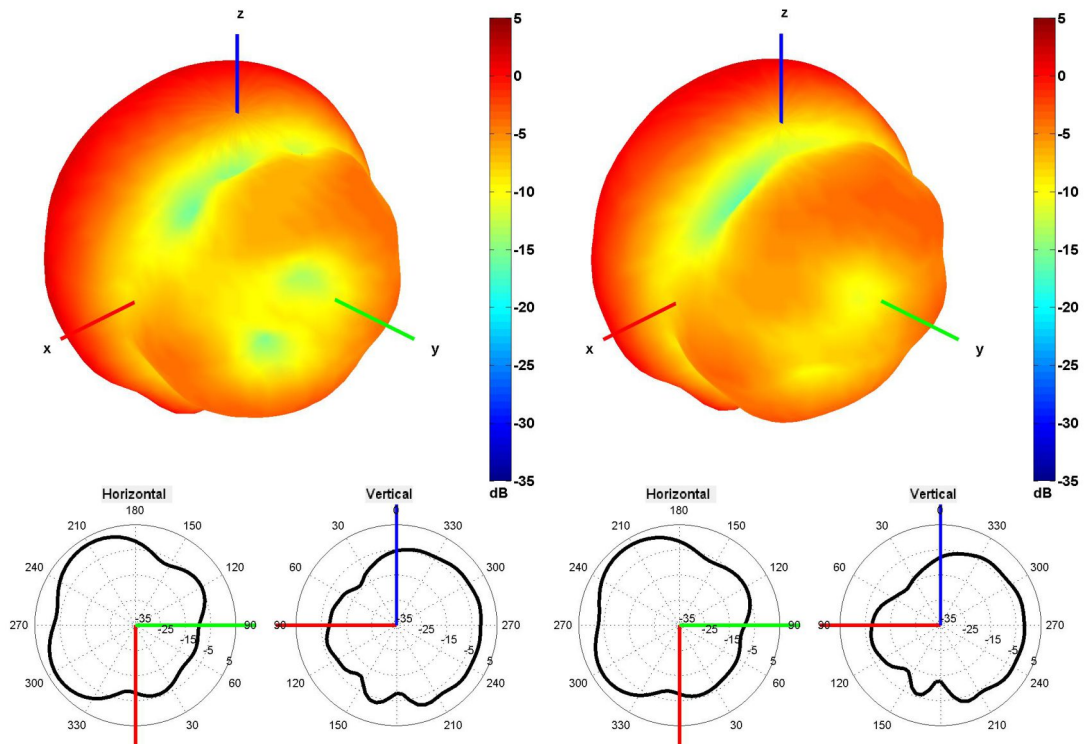

1850 and 1950 MHz Radiation pattern

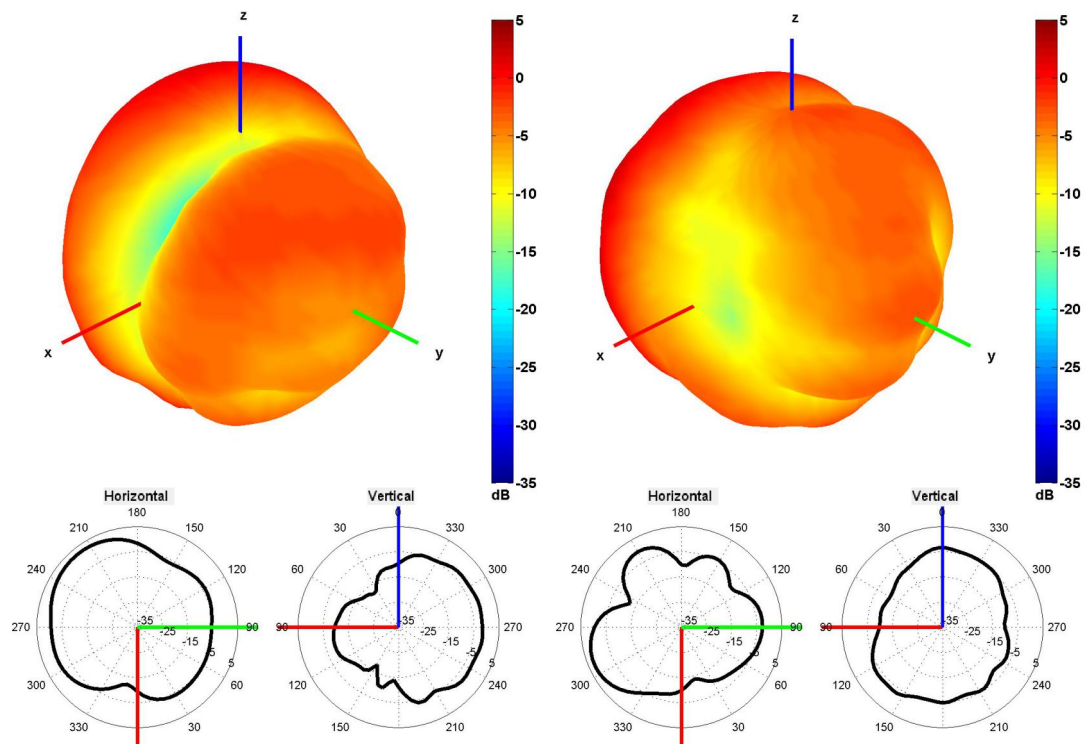

2100 and 2600 MHz Radiation pattern

4. PCB Layout

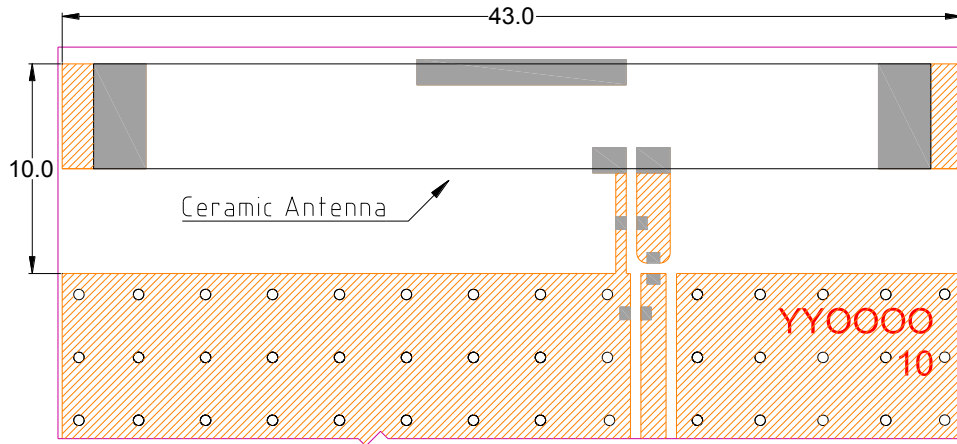

Minimum area required for antenna integration (44.8mm × 10mm)

- Solder Region
- Copper Region
- Copper-Free Region

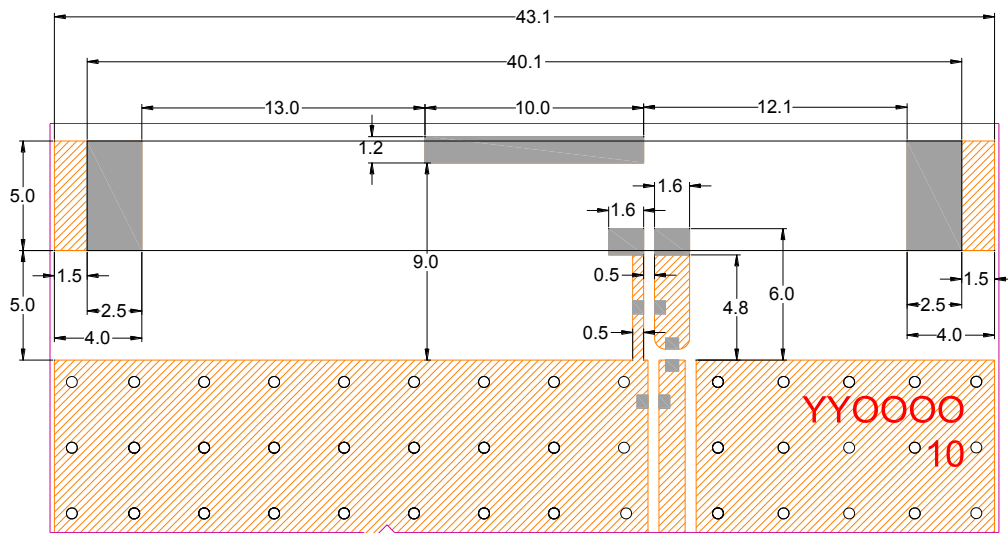

Layout dimensions for antenna integration (mm)

- Solder Region
- Copper Region
- Copper-Free Region

5. Matching Network

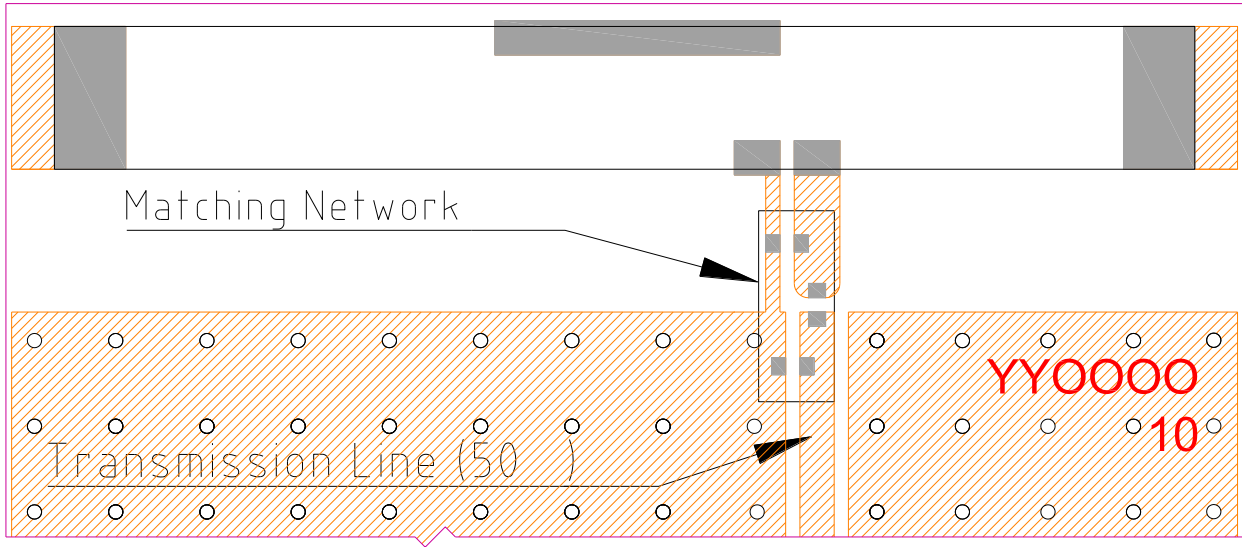

-  Solder Region
-  Copper Region
-  Copper-Free Region

Matching network drawing

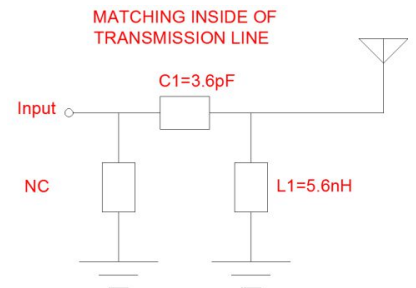
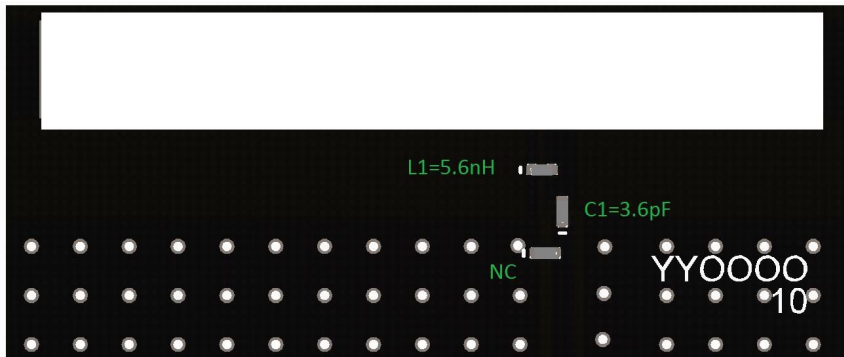

3D View of matching components and recommended values

6. Evaluation Board

118mm x 43.4mm

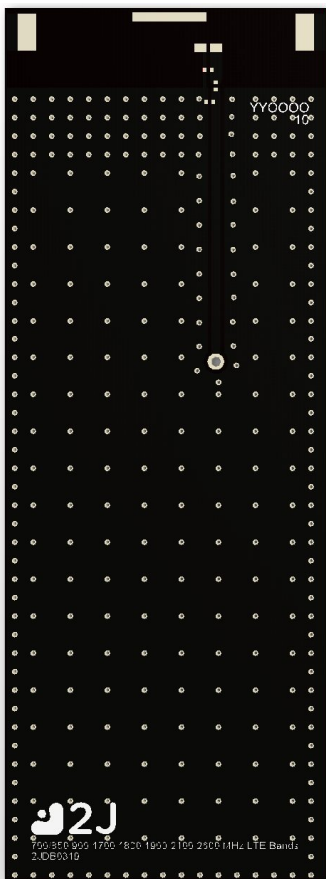

Front View without Antenna

118mm x 43.4mm

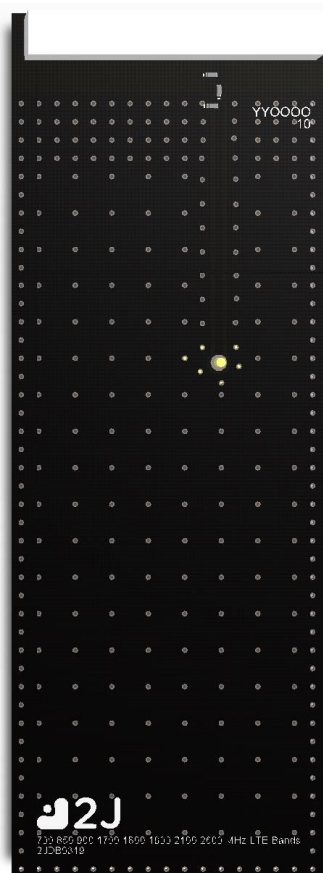

Front View with Antenna

118mm x 43.4mm

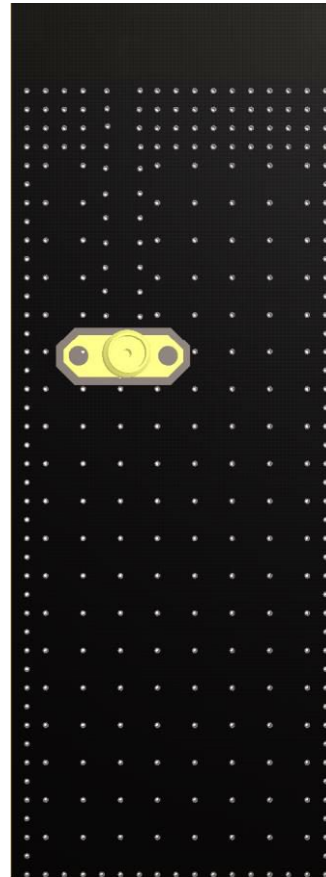

Back View

118mm x 43.4mm
(PCB: 0.8mm, Antenna: 6mm,
Connector: 9.5mm)

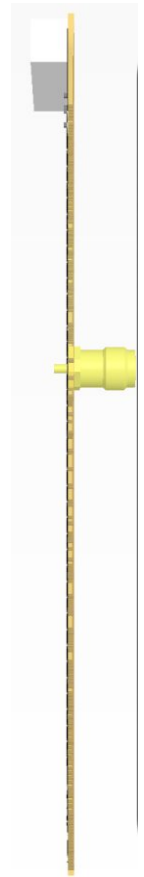

Side View

7. Packaging

PACKAGING SPECIFICATION

Antenna	2JE19
REEL	
Max Quantity per Reel	600
REEL CARTON	
Reels per Carton	2
Max Quantity per Carton	1200
Reel Carton Dimensions (cm)	34 x 35 x 21
Reel Carton Weight (Kg)	3.1
PALLET	
Max Cartons per Pallet	30
Cartons per Layer	6
Number of Layers	5
Max Quantities per Pallet	36,000
Total Cartons Dimensions (cm)	105 x 68 x 105
Total Cartons Weight (Kg)	93
Pallet size and weight not included above	
Typical Pallet Size (cm)	120 x 100 x 14.4
Typical Pallet Weight (Kg)	5-25

8. Tape and Reel Information

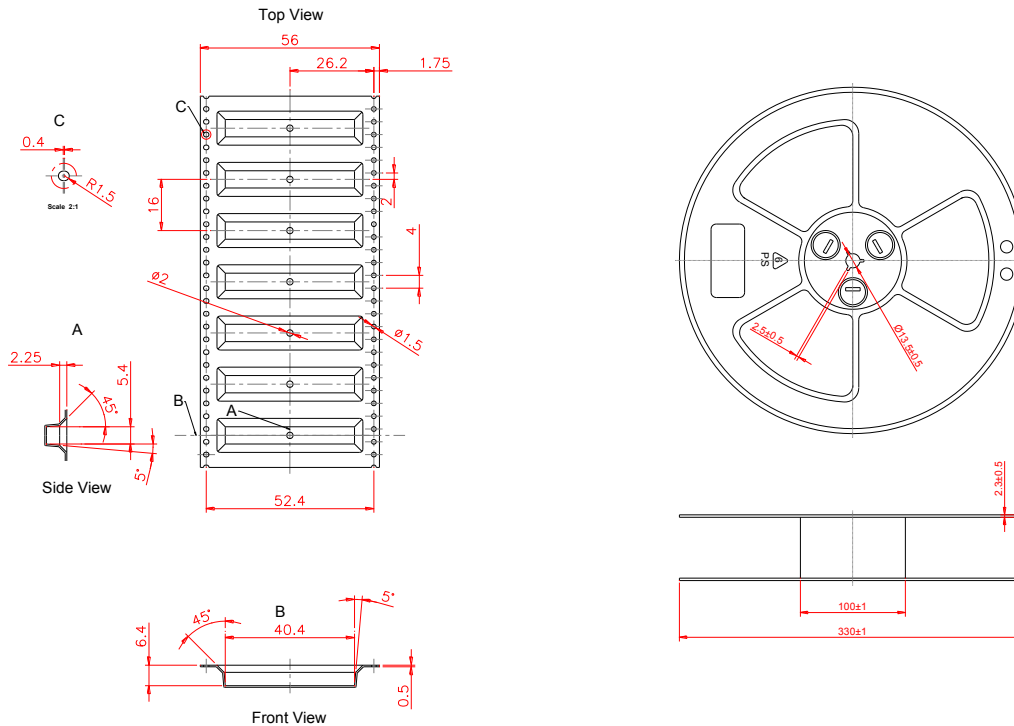

Tape and Reel Specifications

REFLOW TEMPERATURE PROFILE

Minimum Recommended Reflow Profile

	Method of heat transfer	Controlled hot air convection
1	Average temperature gradient in preheating	2.5 °C/s
2	Soak time	2-3 minutes
3	Max temperature gradient in reflow	3 °C/s
4	Time above 217 °C	Max 30 sec
5	Peak temperature in reflow	230 °C for 10 seconds
6	Temperature gradient in cooling	Max -5 °C/s

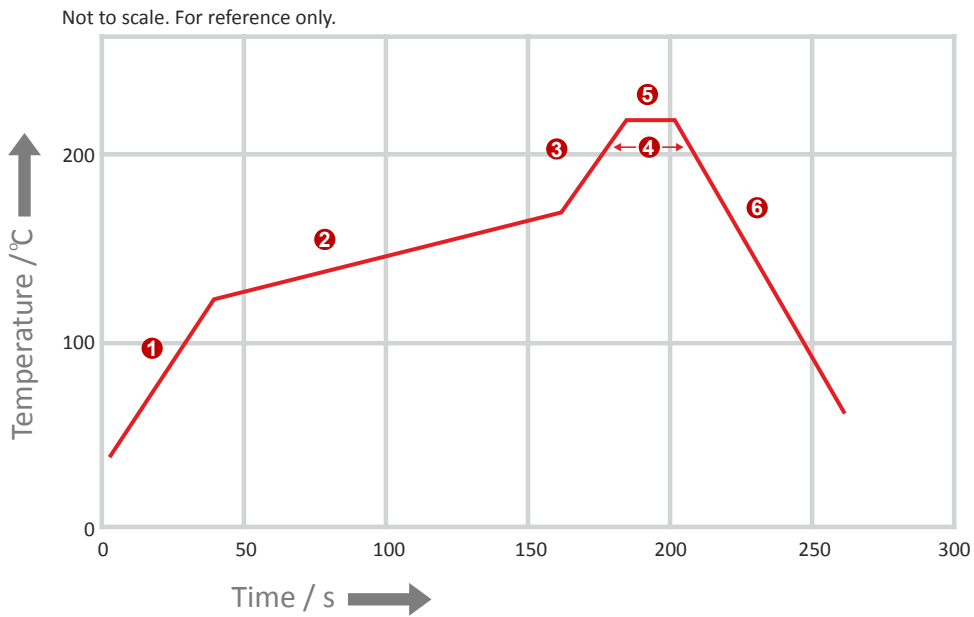

REFLOW TEMPERATURE PROFILE

Maximum Recommended Reflow Profile

	Method of heat transfer	Controlled hot air convection
1	Average temperature gradient in preheating	2.5 °C/s
2	Soak time	2-3 minutes
3	Max temperature gradient in reflow	3 °C/s
4	Time above 217 °C	Max 60 sec
5	Time above 230 °C	Max 50 sec
6	Time above 250 °C	Max 10 sec
7	Peak temperature in reflow	260 °C for 5 seconds
8	Temperature gradient in cooling	Max -5 °C/s

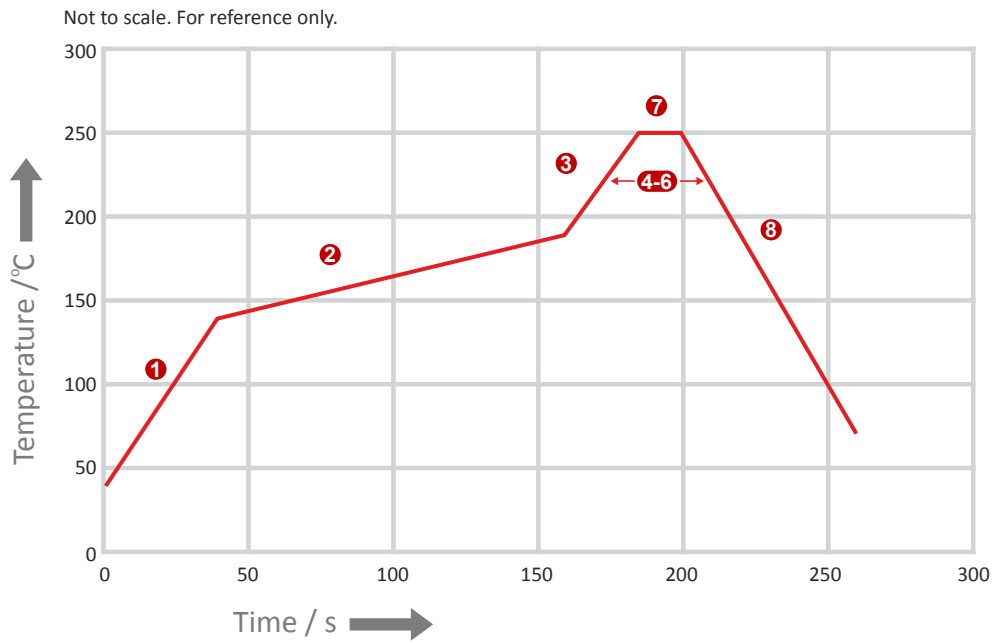

9. Antenna drawings

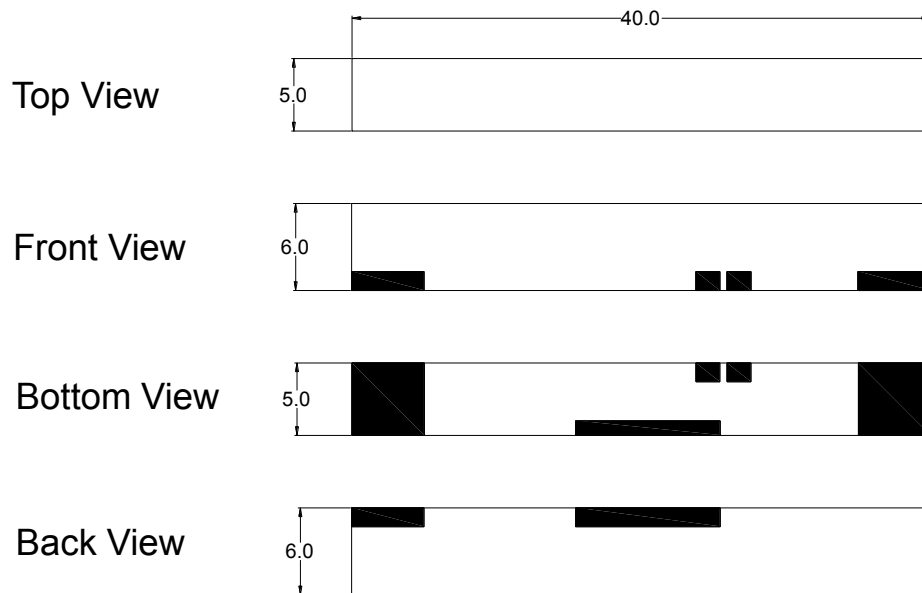

Dimensions for ceramic antenna 40 x 5 x 6 mm

10. Antenna Images

