

2J7A84BGFa

2× 5GNR MIMO and GPS/GLONASS Screw Mount

Key Features

Cable 1 - 2: 5GNR

- 617-960 MHz
- 1427-2690 MHz
- 3300-5000 MHz
- 5150-5925 MHz

Cable 3: GPS/GLONASS/QZSS/Galileo

- 1575-1606 MHz

Screw Mount

Heavy Duty antenna

High Performance

Ground Plane Independent

Anti-Rotation Mounting

Customizable Cable and Connector

Dimensions: Ø 96 x H 90 mm

Certificates: IP67, IP69, Ik09



1. Antenna and electrical specifications

Cable 1

| Parameters | 5GNR Antenna | | | |
|----------------------|---|---|---------------------------------|----------------------|
| Technologies | 5G, 4G, 3G and 2G | | | |
| Standards | 5GNR/4GLTE/FirstNet/CBRS/LPWA/CAT-X/CAT-Mx/CAT-NBx/NB-IoT/3G/2G | | | |
| Frequency (MHz) | 617-960 | 1427-2690 | 3300-5000 | 5150-5925 |
| Band (MHz) | 600, 700, 850, 900 | 1500, 1600, 1700, 1800, 1900, 2000, 2100, 2300, 2500, 2600 | 3300, 3500, 3600, 3700, 4500 | 5200, 5500, 5800 |
| 5GNR Bands | n5, n8, 12, n20, n28, n71, n81, n82, n83, | n1, n2, n3, n7, n25, n34, n38, n39, n40, n41, n50, n51, n66, n70, n74, n75, n76, n80, n84, n86 | n77, n78, n79 | |
| 4GLTE Bands | B5, B6, B8, B12, B13, B14, B17, B18, B19, B20, B26, B27, B28, B29, B44, B67, B68, B71, B85 | B1, B2, B3, B4, B7, B9, B10, B11, B21, B23, B24, B25, B30, B32, B33, B34, B35, B36, B37, B38, B39, B40, B41, B45, B50, B51, B65, B66, B69, B70, B74, B75, B76 | B22, B42, B43, B48, B49, B52 | B46, B47, B252, B255 |
| 3GCELL Bands | B5, B6, B8, B12, B13, B14, B19, B20, B26 | B1, B2, B3, B4, B7, B9, B10, B11, B21, B25, B32, B33, B34, B35, B36, B37, B38, B39, B40 | B22 | |
| 2GCELL Bands | 710, 750, 810T, 850, 900P, 900E, 900R | 1800DCS, 1900PCS | | |
| CDMACELL Bands | BC0, BC2, BC3, BC7, BC9, BC10, BC12, BC18, BC19 | BC1, BC4, BC6, BC8, BC13, BC14, BC15, BC16, BC20, BC21 | | |
| Return Loss (dB) | ~-7.9 | ~-13.3 | ~-11.4 | ~-12.9 |
| VSWR | ~2.6:1 | ~1.7:1 | ~1.9:1 | ~1.7:1 |
| Efficiency (%) | ~44.1 | ~56.3 | ~44.0 | ~42.4 |
| Peak Gain (dBi) | ~1.4 | ~3.6 | ~3.4 | ~3.8 |
| Average Gain (dB) | ~-3.6 | ~-2.5 | ~-3.6 | ~-3.7 |
| Impedance (Ohm) | 50 | | | |
| Polarisation | Linear | | | |
| Radiation Pattern | Omni-Directional | | | |
| Max. Input Power (W) | 35 | | | |
| Connector Type | SMA-Male Standard (Other Connectors Available) | | | |
| Cable Length | 300 cm Standard (Any Cable Length Available) | | | |
| Cable Type | LL195 Standard (Other Cables Available) | | | |

Cable 2

| Parameters | 5GNR Antenna | | | |
|----------------------|---|---|---------------------------------|----------------------|
| Technologies | 5G, 4G, 3G and 2G | | | |
| Standards | 5GNR/4GLTE/FirstNet/CBRS/LPWA/CAT-X/CAT-Mx/CAT-NBx/NB-IoT/3G/2G | | | |
| Frequency (MHz) | 617-960 | 1427-2690 | 3300-5000 | 5150-5925 |
| Band (MHz) | 600, 700, 850, 900 | 1500, 1600, 1700, 1800, 1900, 2000, 2100, 2300, 2500, 2600 | 3300, 3500, 3600, 3700, 4500 | 5200, 5500, 5800 |
| 5GNR Bands | n5, n8 ,12, n20, n28, n71, n81, n82, n83, | n1, n2, n3, n7, n25, n34, n38, n39, n40, n41, n50, n51, n66, n70, n74, n75, n76, n80, n84, n86 | n77, n78, n79 | |
| 4GLTE Bands | B5, B6, B8, B12, B13, B14, B17, B18, B19, B20, B26, B27, B28, B29, B44, B67, B68, B71, B85 | B1, B2, B3, B4, B7, B9, B10, B11, B21, B23, B24, B25, B30, B32, B33, B34, B35, B36, B37, B38, B39, B40, B41, B45, B50, B51, B65, B66, B69, B70, B74, B75, B76 | B22, B42, B43, B48, B49, B52 | B46, B47, B252, B255 |
| 3GCELL Bands | B5, B6, B8, B12, B13, B14, B19, B20, B26 | B1, B2, B3, B4, B7, B9, B10, B11, B21, B25, B32, B33, B34, B35, B36, B37, B38, B39, B40 | B22 | |
| 2GCELL Bands | 710, 750, 810T, 850, 900P, 900E, 900R | 1800DCS, 1900PCS | | |
| CDMACELL Bands | BC0, BC2, BC3, BC7, BC9, BC10, BC12, BC18, BC19 | BC1, BC4, BC6, BC8, BC13, BC14, BC15, BC16, BC20, BC21 | | |
| Return Loss (dB) | ~-7.7 | ~-12.4 | ~-11.9 | ~-11.9 |
| VSWR | ~2.7:1 | ~1.7:1 | ~2.0:1 | ~1.8:1 |
| Efficiency (%) | ~44.6 | ~54.8 | ~43.0 | ~47.1 |
| Peak Gain (dBi) | ~1.5 | ~3.6 | ~3.5 | ~3.8 |
| Average Gain (dB) | ~-3.5 | ~-2.7 | ~-3.7 | ~-3.3 |
| Impedance (Ohm) | 50 | | | |
| Polarisation | Linear | | | |
| Radiation Pattern | Omni-Directional | | | |
| Max. Input Power (W) | 35 | | | |
| Connector Type | SMA-Male Standard (Other Connectors Available) | | | |
| Cable Length | 300 cm Standard (Any Cable Length Available) | | | |
| Cable Type | LL195 Standard (Other Cables Available) | | | |

Antenna Measurement Conditions:

Mounted on Metal Plate of 30 x 30 cm
 200 cm of Cable LL195
 Measured in Certified CTIA 3D Anechoic Chamber

Cable 3

| Parameters | GPS/GLONASS Antenna | |
|------------------------------------|--|-----------|
| | GPS/QZSS/Galileo | GLONASS |
| Standard | | |
| Band (MHz) | 1575 | 1602 |
| Frequency(MHz) | 1575.42 | 1598-1610 |
| Return Loss (dB) | <=-14 | |
| VSWR | <=1.5:1 | |
| Impedance | 50 | |
| Radiation Pattern | Hemispherical | |
| Polarization | RHCP | |
| Saw Filter | Post-Filter | |
| Active Gain (dB) | 23 @ 3 V, 24 @ 5 V | |
| Noise Figure (dB) | 1.2 | |
| Voltage (V) | 2.7 - 5.5 | |
| Current Consumption (mA) | 15 - 25 | |
| Power Consumption (mW) | 40.5 - 137.5 | |
| Out of Band Rejection (dBc) | ~32 | |
| Connector Type | SMA-Male Standard (Other Connectors Available) | |
| Cable Length | 300 cm Standard (Any Cable Length Available) | |
| Cable Type | LL100 Standard (Other Cables Available) | |

2. Mechanical and environmental specifications

| Specifications | 2J7A84BGFa |
|----------------------------------|------------------|
| Mounting Type | Screw Mount |
| Dimensions (mm) | Ø 96 x H 90 |
| Max. Tighten Torque (Nm) | 6 Nm |
| Radome | ASA |
| Radome color | White, Black |
| Antenna Base | ASA |
| Operating Temperature (C) | -40 to +85 |
| Storage Temperature (C) | -40 to +85 |
| Substance Compliance | RoHS |
| Certificates | IP67, IP69, IK09 |

3. Antenna parameters

Cable 1: 5GNR

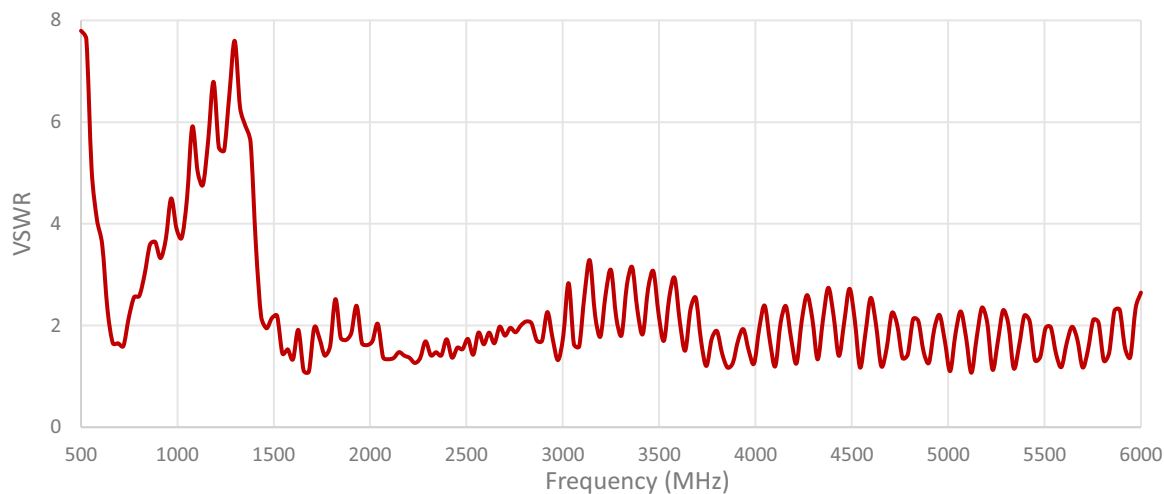
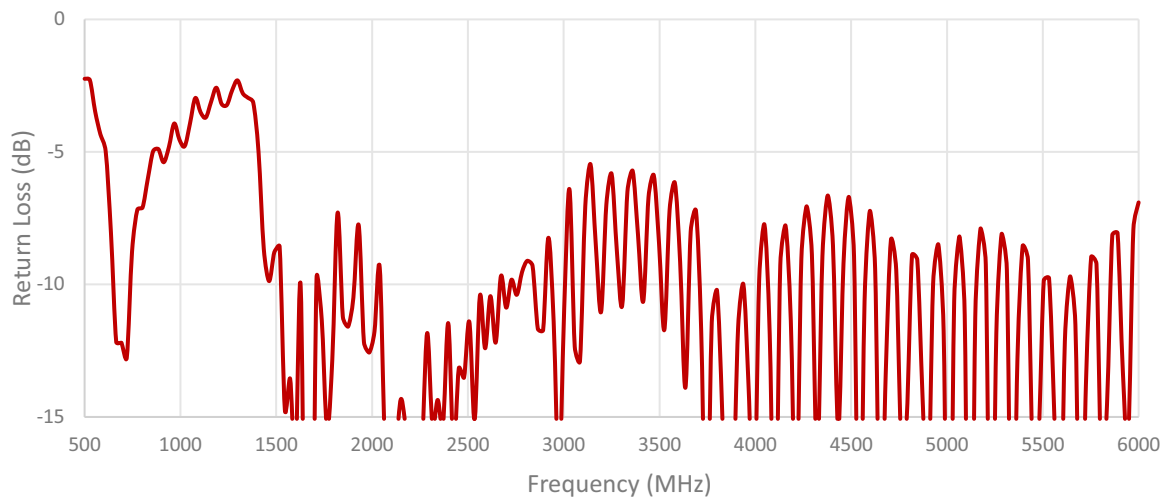

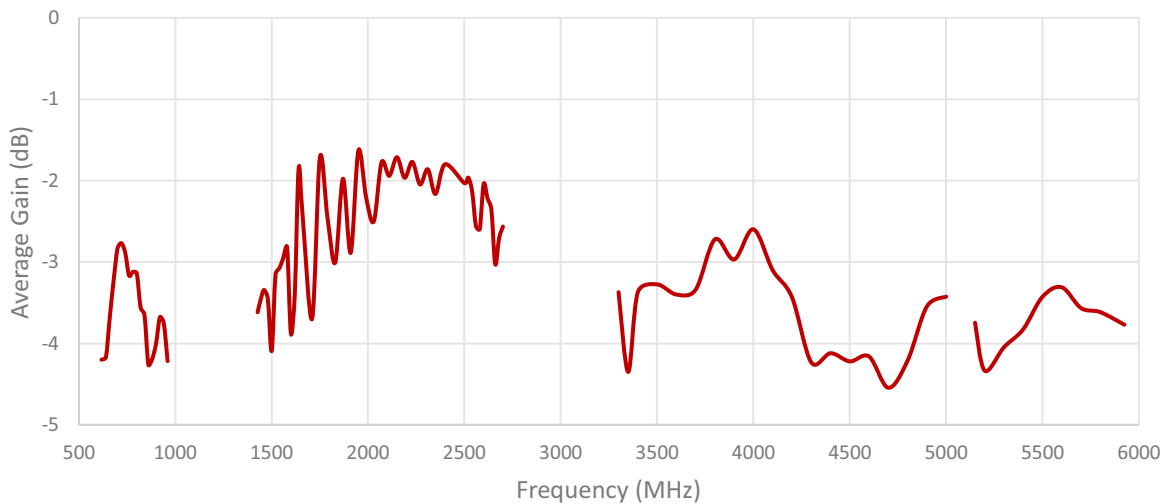
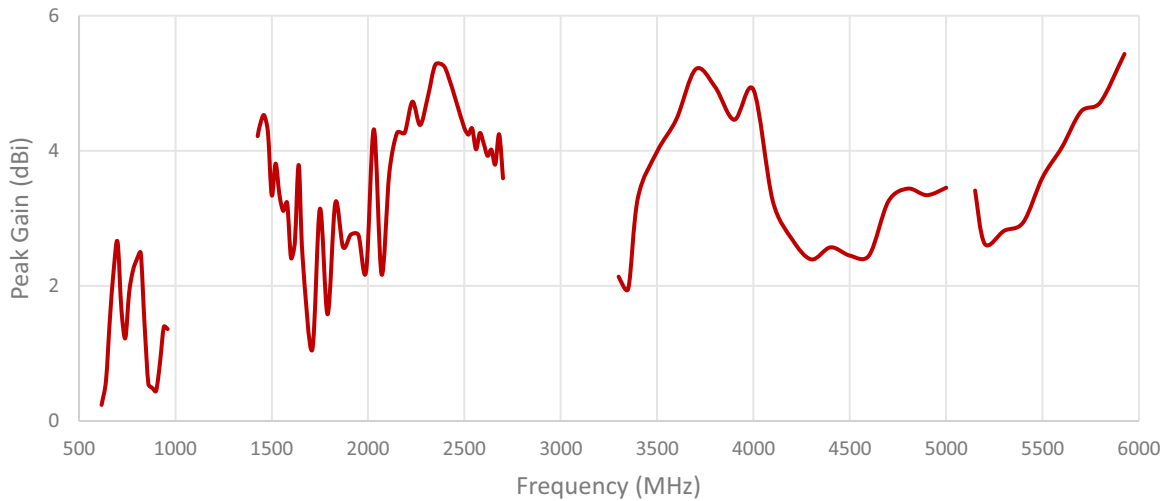
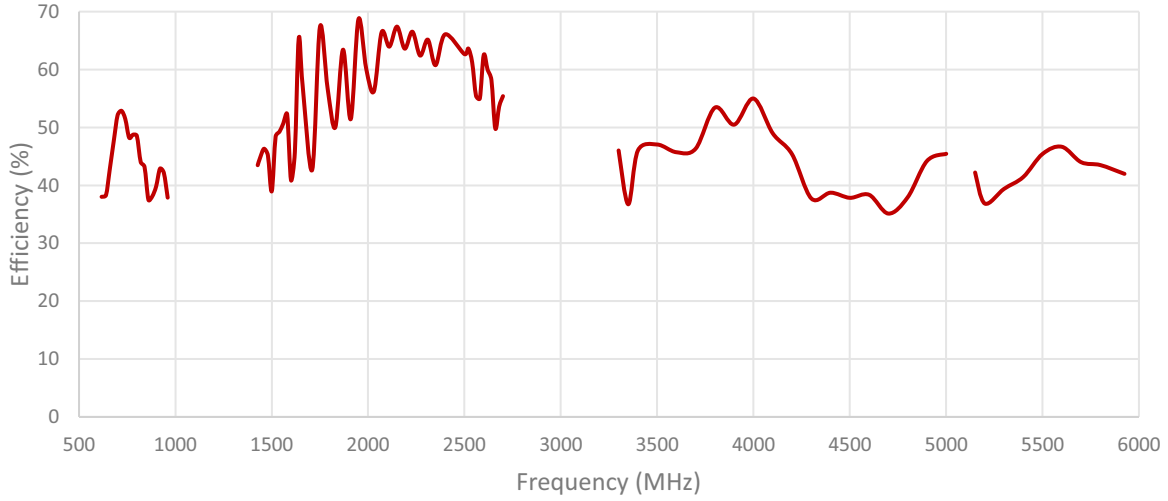

Cable 2: 5GNR

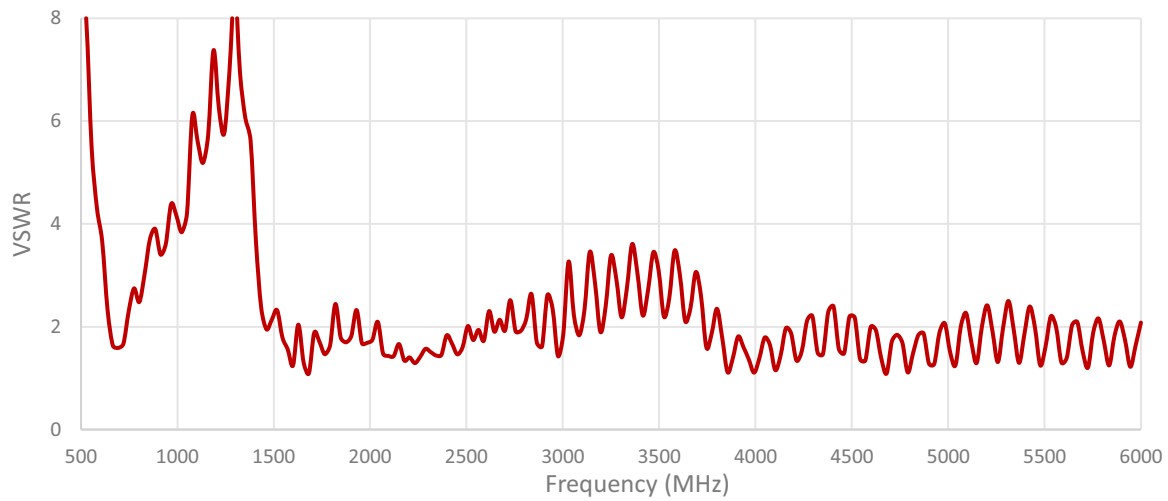
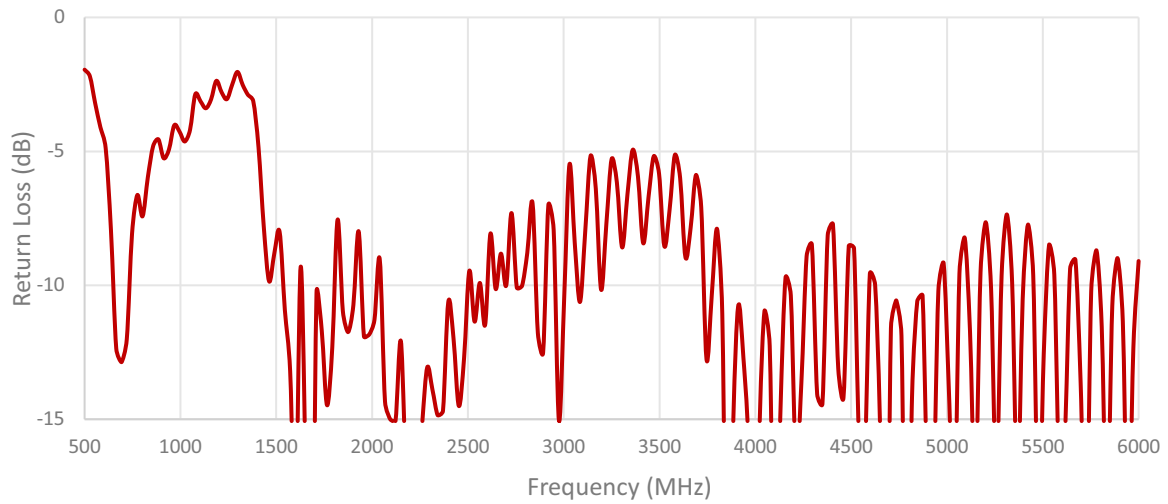

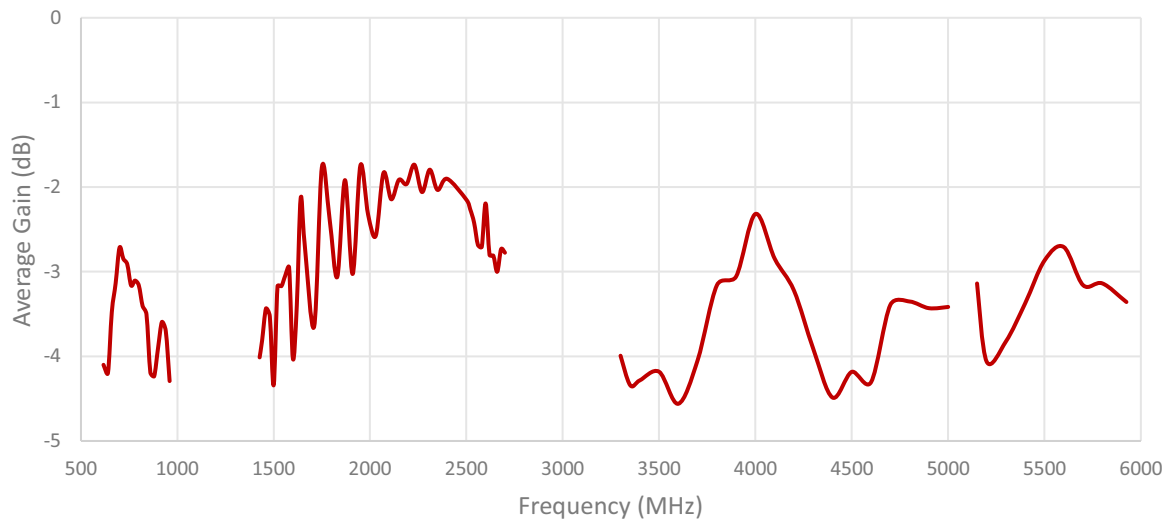
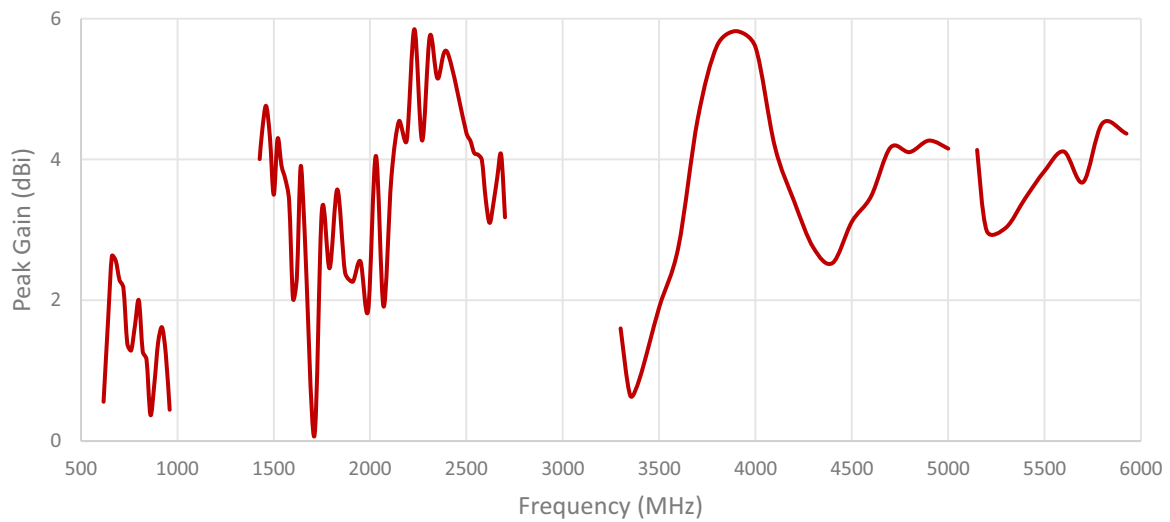
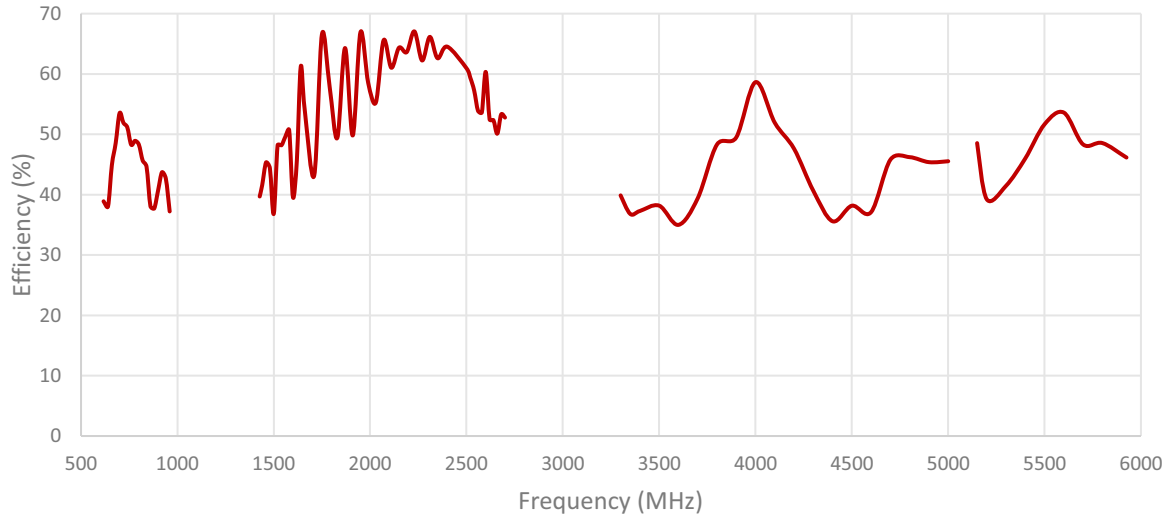

ISOLATION FOR CABLES 1 AND 2

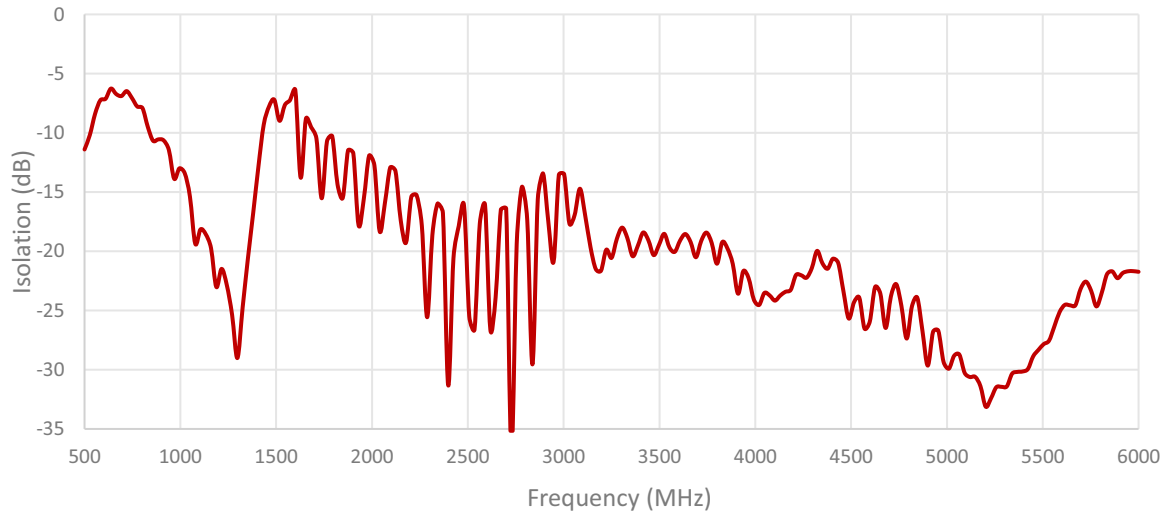

ENVELOPE CORRELATION COEFFICIENT FOR CABLES 1 AND 2

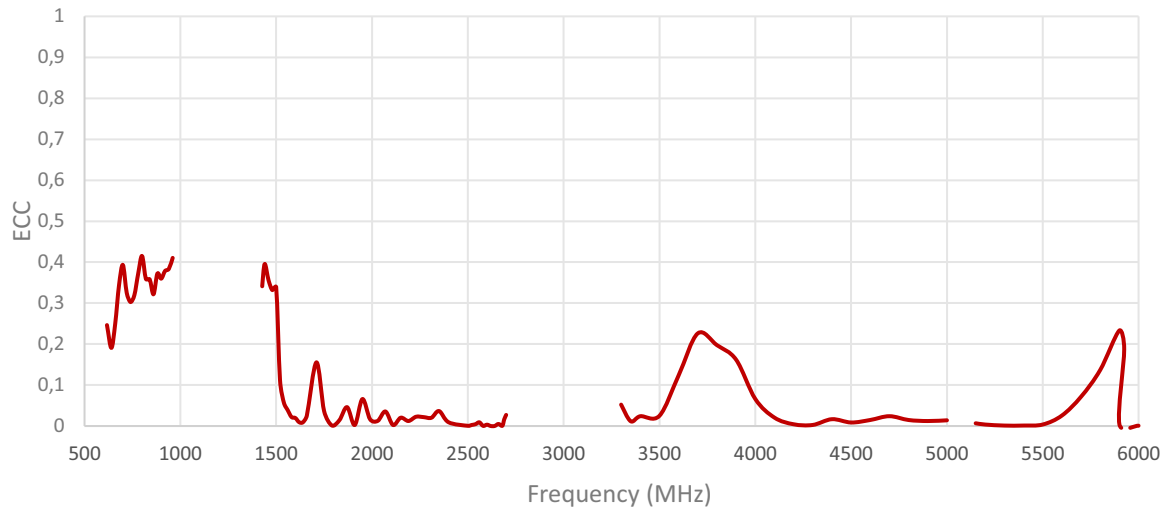



Radiation pattern reference

Cable 1: 5GNR

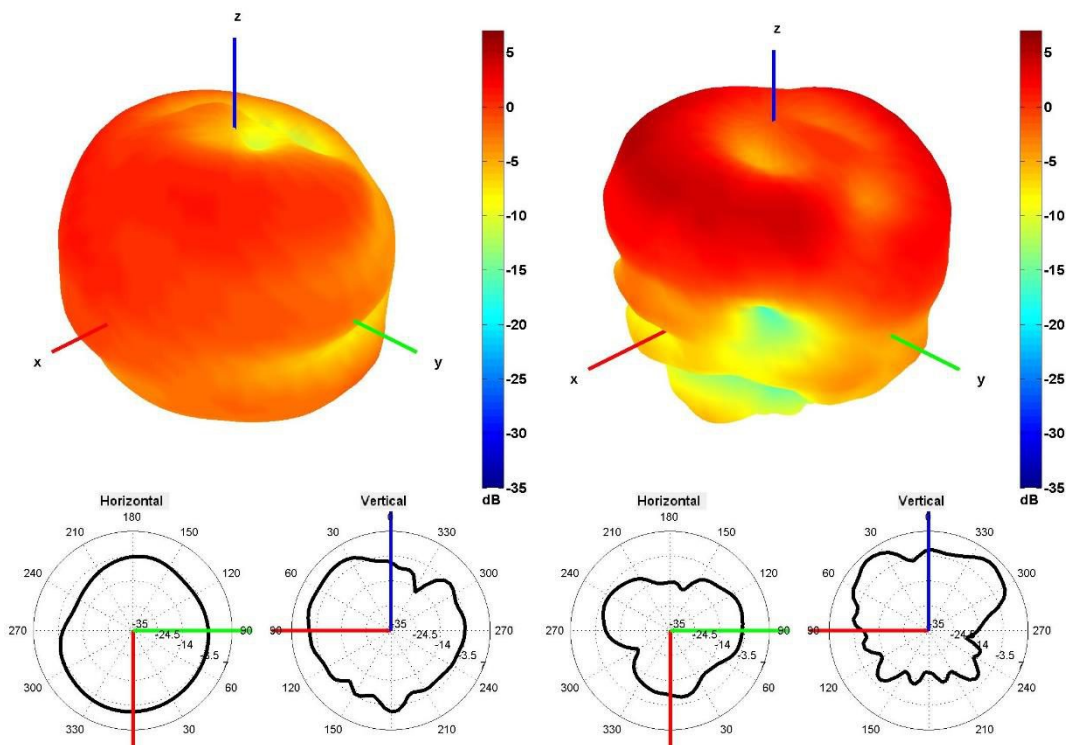

750 and 2500 MHz Radiation pattern

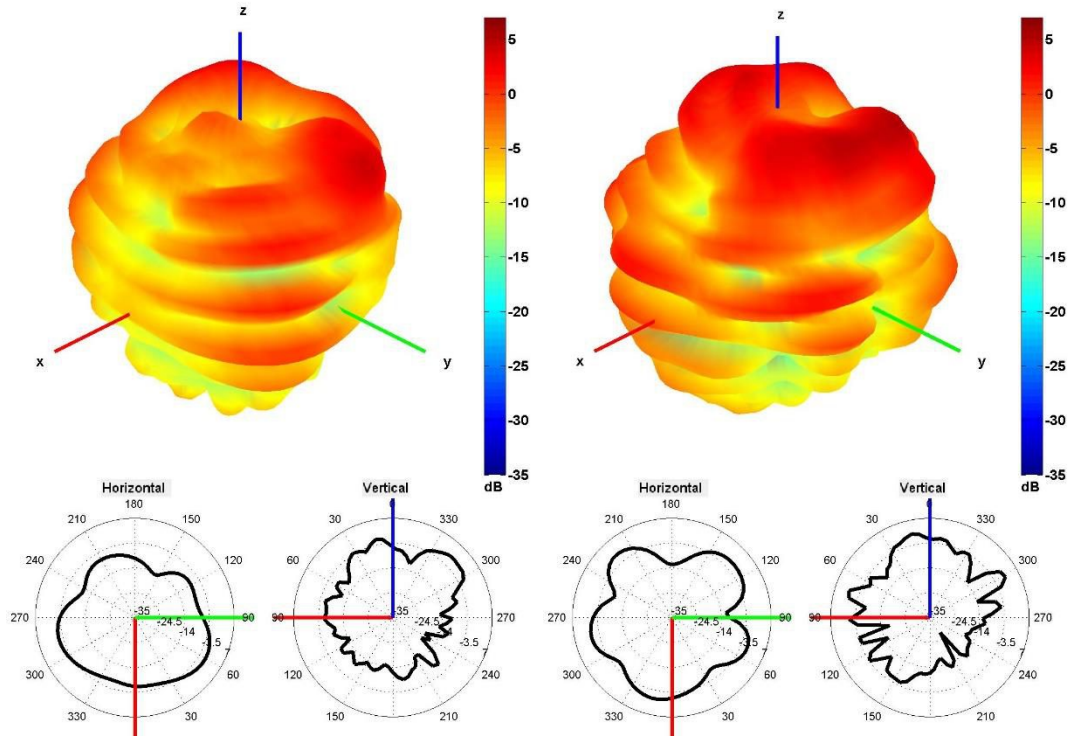

Cable 2: 5GNR

450 and 550 MHz Radiation pattern

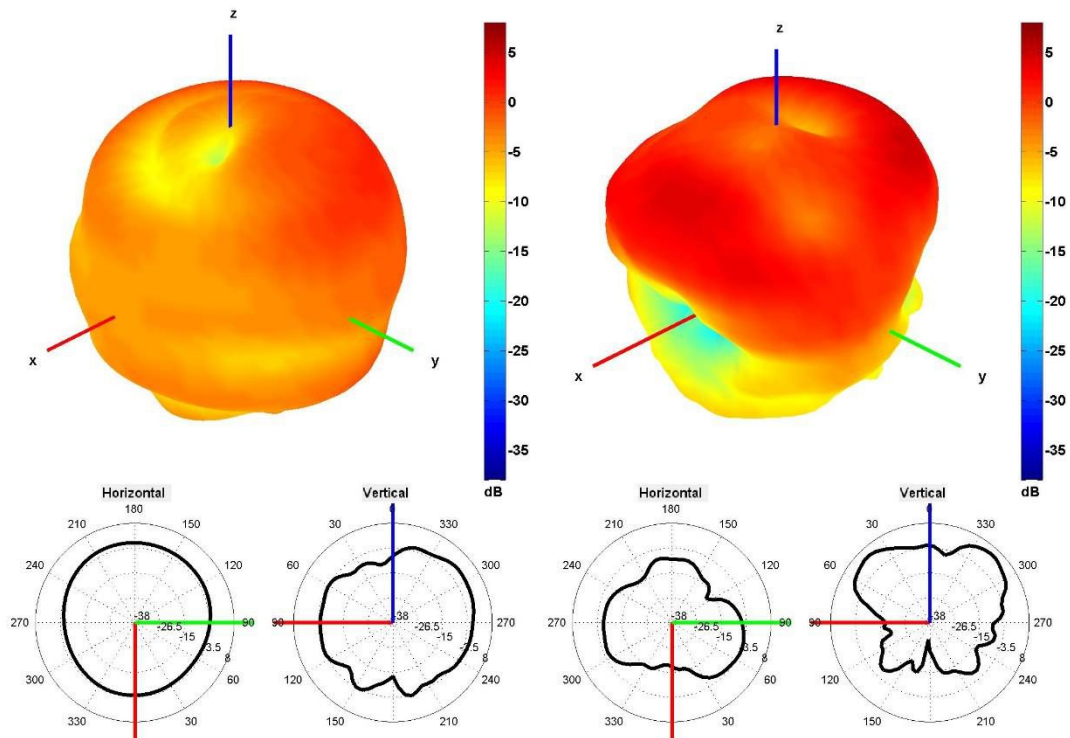

750 and 2500 MHz Radiation pattern

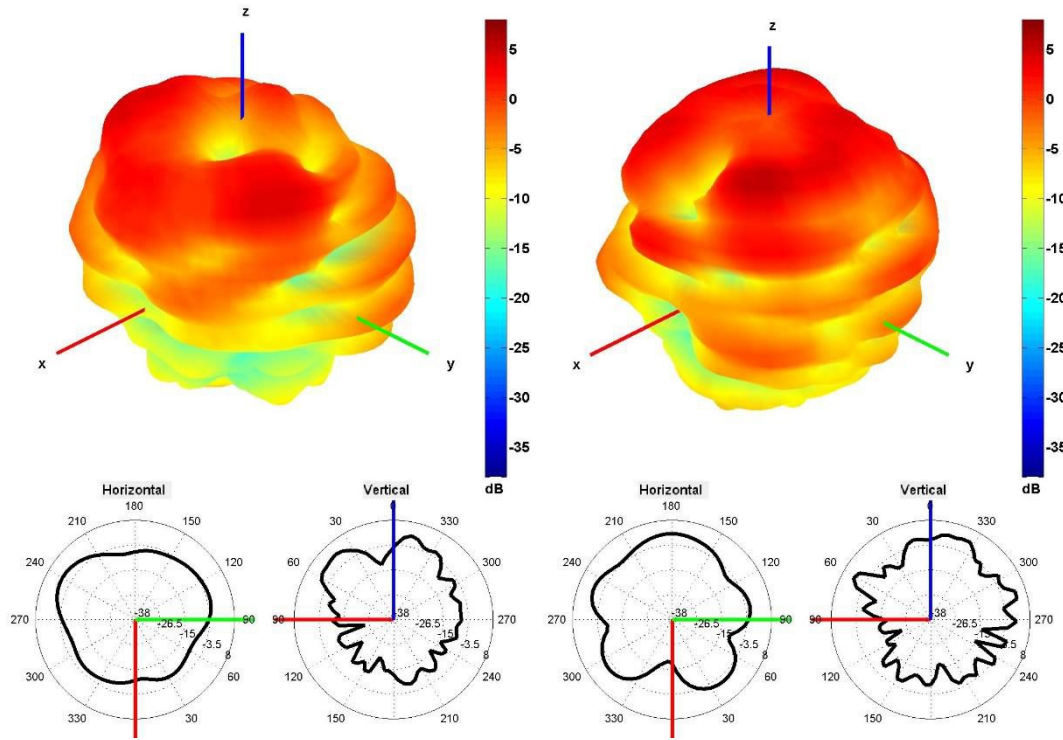

4500 and 5500 MHz Radiation pattern

4. Antenna drawings

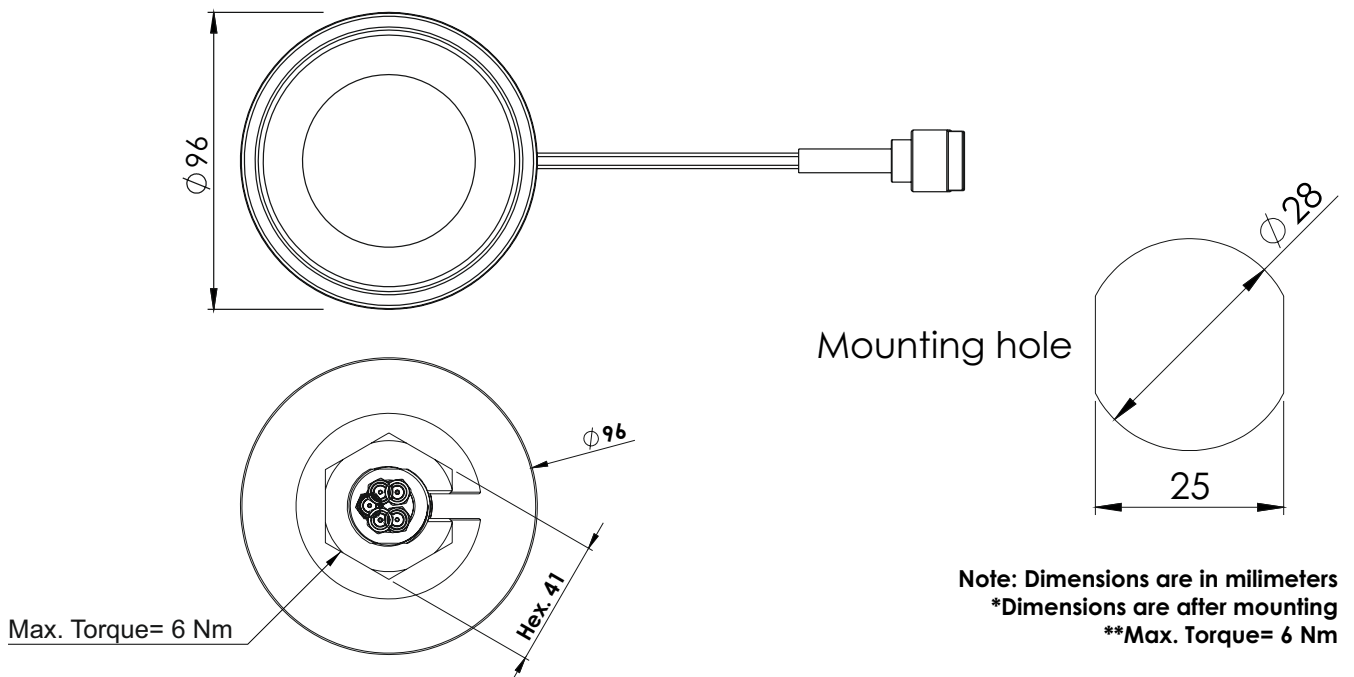
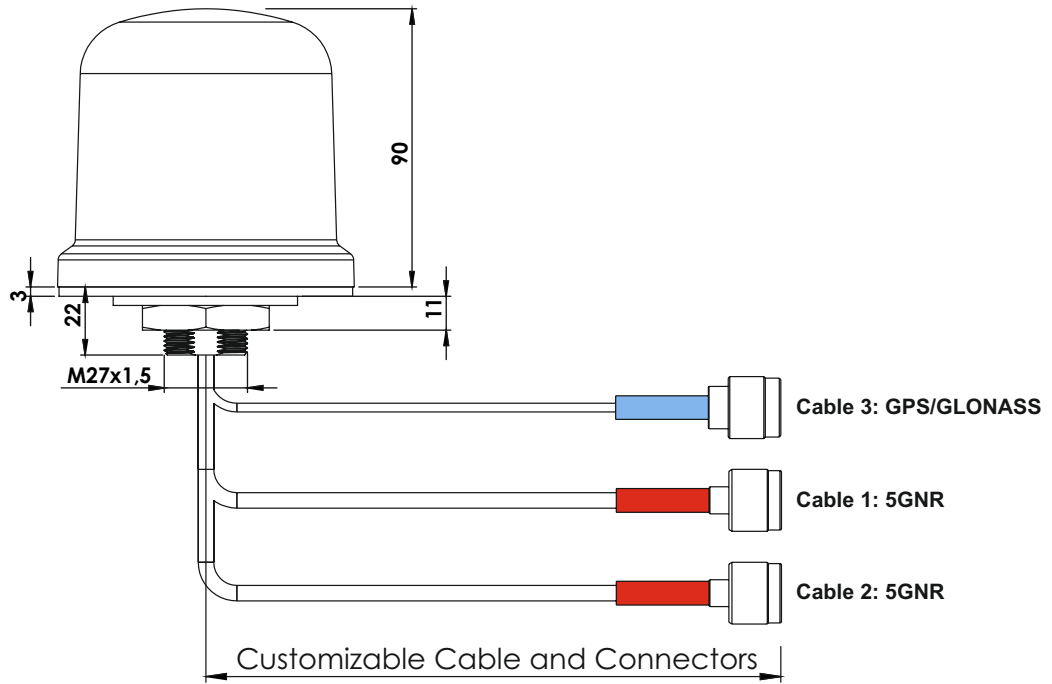

5. Antenna Images

