

2J6C85Bc

2× 5GNR MIMO and 2× 2.4/5.0/6.0 GHz ISM MIMO
Screw Mount

Key Features

Cable 1-2: 5GNR

- 617-960 MHz
- 1427-2690 MHz
- 3300-5000 MHz
- 5150-5925 MHz

Cable 3-4: 2.4/5.0/6.0 GHz ISM

- 2410-2490 MHz
- 4920-7125 MHz

Screw Mount

High Performance

Ground Plane Independent

Anti-Rotation Mounting

Customizable Cable and Connector

Dimensions: 193 × 76.3 × 52.4 mm

Certificates: IP67, IP69



1. Antenna and electrical specifications

Cable 1

Parameters	5G NR Antenna			
Technologies	5G, 4G, 3G and 2G			
Standards	5G NR/4G LTE/FirstNet/CBRS/LPWA/CAT-X/CAT-Mx/CAT-NBx/NB-IoT/3G/2G			
Frequency (MHz)	617-960	1427-2690	3300-5000	5150-5925
Band (MHz)	600, 700, 850, 900	1500, 1600, 1700, 1800, 1900, 2000, 2100, 2300, 2500, 2600	3300, 3500, 3600, 3700, 4500	5200, 5500, 5800
5G NR Bands	n5, n8, 12, n20, n28, n71, n81, n82, n83,	n1, n2, n3, n7, n25, n34, n38, n39, n40, n41, n50, n51, n66, n70, n74, n75, n76, n80, n84, n86	n77, n78, n79	
4G LTE Bands	B5, B6, B8, B12, B13, B14, B17, B18, B19, B20, B26, B27, B28, B29, B44, B67, B68, B71, B85	B1, B2, B3, B4, B7, B9, B10, B11, B21, B23, B24, B25, B30, B32, B33, B34, B35, B36, B37, B38, B39, B40, B41, B45, B50, B51, B65, B66, B69, B70, B74, B75, B76	B22, B42, B43, B48, B49, B52	B46, B47, B252, B255
3G CELL Bands	B5, B6, B8, B12, B13, B14, B19, B20, B26	B1, B2, B3, B4, B7, B9, B10, B11, B21, B25, B32, B33, B34, B35, B36, B37, B38, B39, B40	B22	
2G CELL Bands	710, 750, 810T, 850, 900P, 900E, 900R	1800DCS, 1900PCS		
CDMA CELL Bands	BC0, BC2, BC3, BC7, BC9, BC10, BC12, BC18, BC19	BC1, BC4, BC6, BC8, BC13, BC14, BC15, BC16, BC20, BC21		
Return Loss (dB)	~-6.9	~-15.9	~-15.0	~-6.7
VSWR	~2.7:1	~1.5:1	~1.6:1	~2.8:1
Efficiency (%)	~40.2	~47.3	~35.3	~22.1
Peak Gain (dBi)	~2.5	~5.0	~4.8	~3.3
Average Gain (dB)	~-4.0	~-3.3	~-4.8	~-6.7
Impedance (Ohm)	50			
Polarisation	Linear			
Radiation Pattern	Omni-Directional			
Max. Input Power (W)	25			
Connector Type	SMA-Male Standard (Other Connectors Available)			
Cable Length	300 cm Standard (Any Cable Length Available)			
Cable Type	D302 Standard (Other Cables Available)			

Cable 2

Parameters	5GNR Antenna			
Technologies	5G, 4G, 3G and 2G			
Standards	5GNR/4GLTE/FirstNet/CBRS/LPWA/CAT-X/CAT-Mx/CAT-NBx/NB-IoT/3G/2G			
Frequency (MHz)	617-960	1427-2690	3300-5000	5150-5925
Band (MHz)	600, 700, 850, 900	1500, 1600, 1700, 1800, 1900, 2000, 2100, 2300, 2500, 2600	3300, 3500, 3600, 3700, 4500	5200, 5500, 5800
5GNR Bands	n5, n8 ,12, n20, n28, n71, n81, n82, n83,	n1, n2, n3, n7, n25, n34, n38, n39, n40, n41, n50, n51, n66, n70, n74, n75, n76, n80, n84, n86	n77, n78, n79	
4GLTE Bands	B5, B6, B8, B12, B13, B14, B17, B18, B19, B20, B26, B27, B28, B29, B44, B67, B68, B71, B85	B1, B2, B3, B4, B7, B9, B10, B11, B21, B23, B24, B25, B30, B32, B33, B34, B35, B36, B37, B38, B39, B40, B41, B45, B50, B51, B65, B66, B69, B70, B74, B75, B76	B22, B42, B43, B48, B49, B52	B46, B47, B252, B255
3GCELL Bands	B5, B6, B8, B12, B13, B14, B19, B20, B26	B1, B2, B3, B4, B7, B9, B10, B11, B21, B25, B32, B33, B34, B35, B36, B37, B38, B39, B40	B22	
2GCELL Bands	710, 750, 810T, 850, 900P, 900E, 900R	1800DCS, 1900PCS		
CDMACELL Bands	BC0, BC2, BC3, BC7, BC9, BC10, BC12, BC18, BC19	BC1, BC4, BC6, BC8, BC13, BC14, BC15, BC16, BC20, BC21		
Return Loss (dB)	~-7.1	~-15.4	~-18.1	~-9.2
VSWR	~2.7:1	~1.5:1	~1.4:1	~2.1:1
Efficiency (%)	~39.7	~46.9	~39.8	~33.8
Peak Gain (dBi)	~2.5	~5.0	~5.4	~4.4
Average Gain (dB)	~-4.0	~-3.3	~-4.1	~-4.8
Impedance (Ohm)	50			
Polarisation	Linear			
Radiation Pattern	Omni-Directional			
Max. Input Power (W)	25			
Connector Type	SMA-Male Standard (Other Connectors Available)			
Cable Length	300 cm Standard (Any Cable Length Available)			
Cable Type	D302 Standard (Other Cables Available)			

Antenna Measurement Conditions:

Mounted on Metal Plate of 30 x 30 cm
 100 cm of Cable D302
 Measured in Certified CTIA 3D Anechoic Chamber

Cable 3

Parameters	2.4/5.0/6.0 GHz ISM Antenna		
Standards	WiFi, BT, ZigBee, ISM, Sigfox, LoRa		
Band (MHz)	2.4GHz	5.0 GHz	6.0GHz
Frequency (MHz)	2410-2490	4920-5925	5925-7125
Return Loss (dB)	~-16.7	~-18.6	~-12.3
VSWR	~1.5:1	~1.3:1	~1.8:1
Efficiency (%)	~49.2	~48.2	~32.1
Peak Gain (dBi)	~4.2	~6.4	~5.3
Average Gain (dB)	~-3.1	~-3.2	~-3.8
Impedance (Ohm)	50		
Polarisation	Linear		
Radiation Pattern	Omni-Directional		
Max. Input Power (W)	25		
Connector Type	SMA-Male-RP Standard (Other Connectors Available)		
Cable Length	300 cm Standard (Any Cable Length Available)		
Cable Type	D302 Standard (Other Cables Available)		

Cable 4

Parameters	2.4/5.0/6.0 GHz ISM Antenna		
Standards	WiFi, BT, ZigBee, ISM, Sigfox, LoRa		
Band (MHz)	2.4 GHz	5.0 GHz	6.0 GHz
Frequency (MHz)	2410-2490	4920-5925	5925-7125
Return Loss (dB)	~-12.0	~-15.3	~-11.8
VSWR	~1.7:1	~1.6:1	~1.8:1
Efficiency (%)	~46.3	~43.2	~27.6
Peak Gain (dBi)	~3.1	~6.5	~4.7
Average Gain (dB)	~-3.4	~-3.7	~-4.4
Impedance (Ohm)	50		
Polarisation	Linear		
Radiation Pattern	Omni-Directional		
Max. Input Power (W)	25		
Connector Type	SMA-Male-RP Standard (Other Connectors Available)		
Cable Length	300 cm Standard (Any Cable Length Available)		
Cable Type	D302 Standard (Other Cables Available)		

Antenna Measurement Conditions:

Mounted on Metal Plate of 30 x 30 cm
 100 cm of Cable D302
 Measured in Certified CTIA 3D Anechoic Chamber

2. Mechanical and environmental specifications

Specifications	2J6C85Bc
Mounting Type	Screw Mount
Dimensions (mm)	193 × 76.3 × 52.4
Recommended Torque (Nm)	6 Nm
Radome Type	ASA
Radome color	Black, White
Operating Temperature (C)	-40 to +85
Storage Temperature (C)	-40 to +85
Substance Compliance	RoHS
Certificates	IP67, IP69

3. Antenna parameters

Cable 1: 5GNR

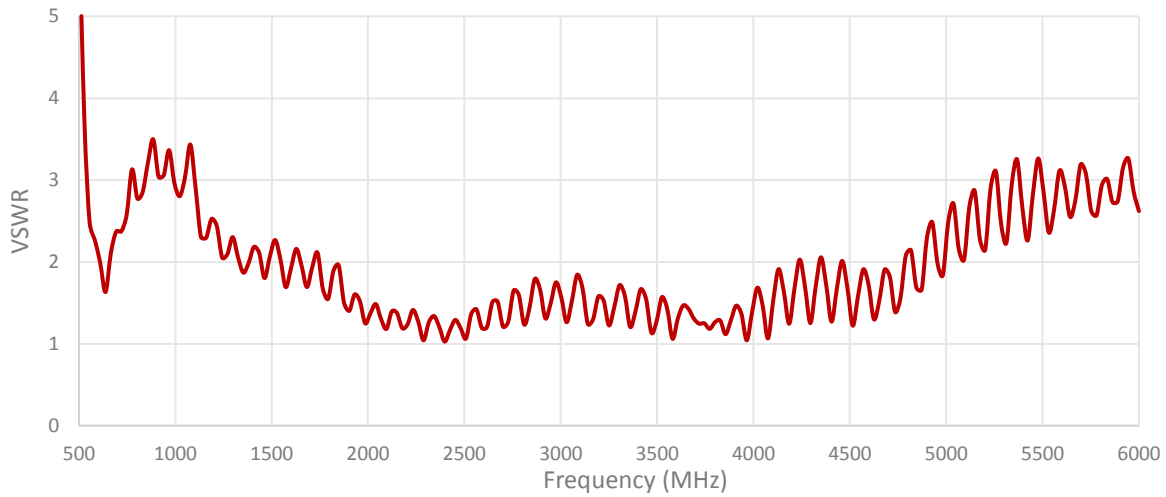
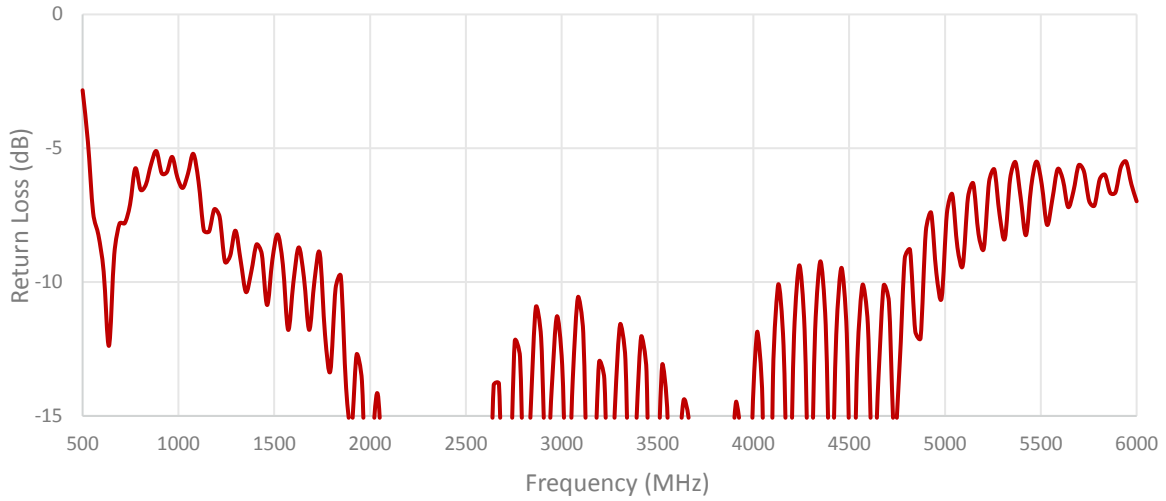

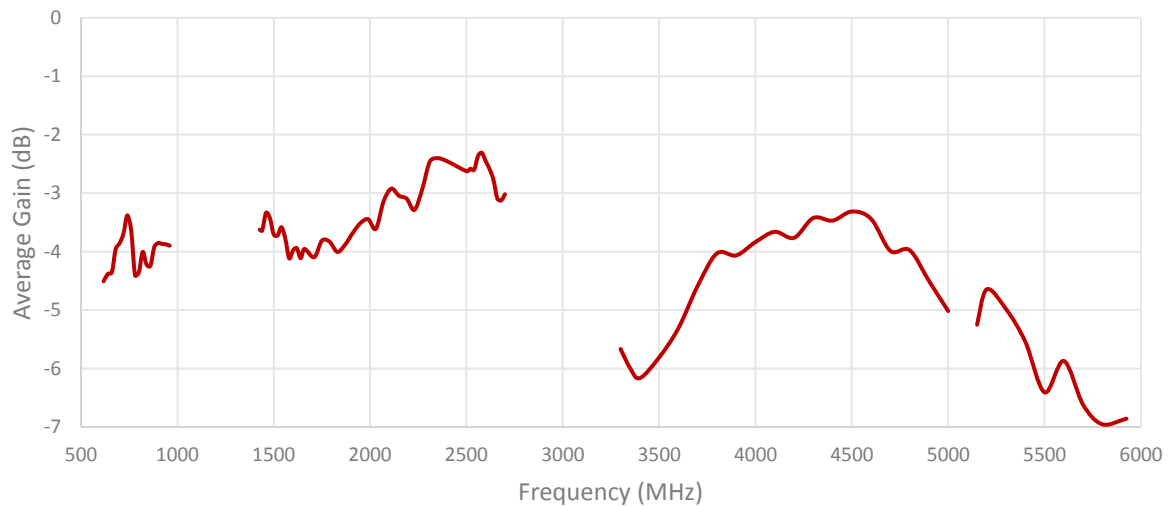
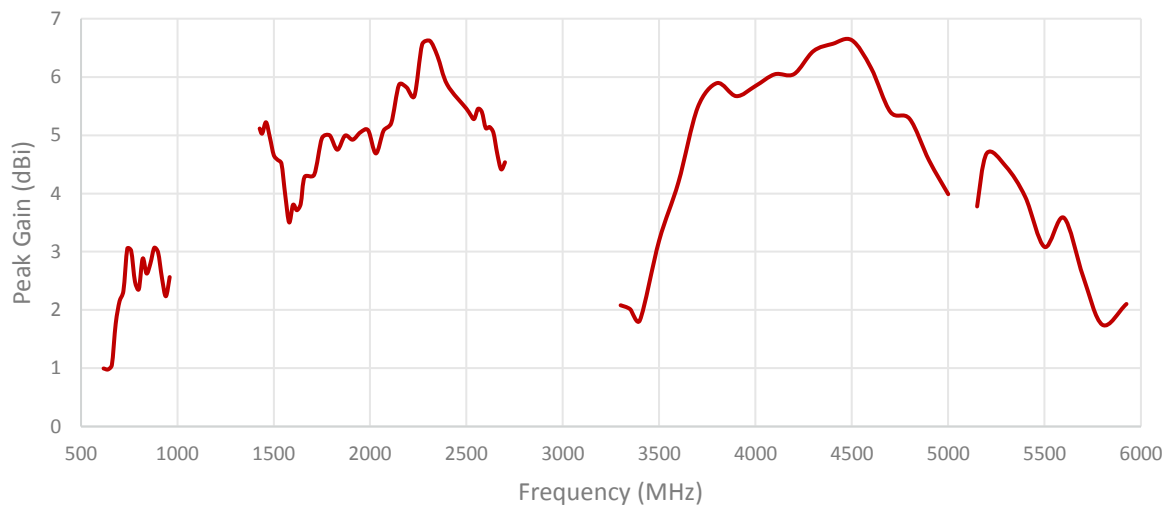
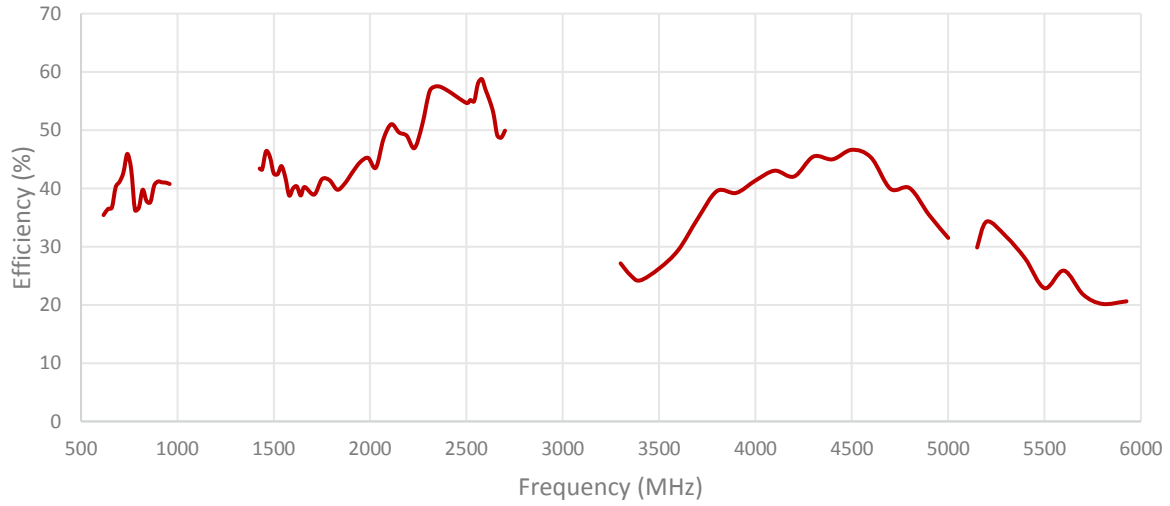

Cable 2: 5G NR

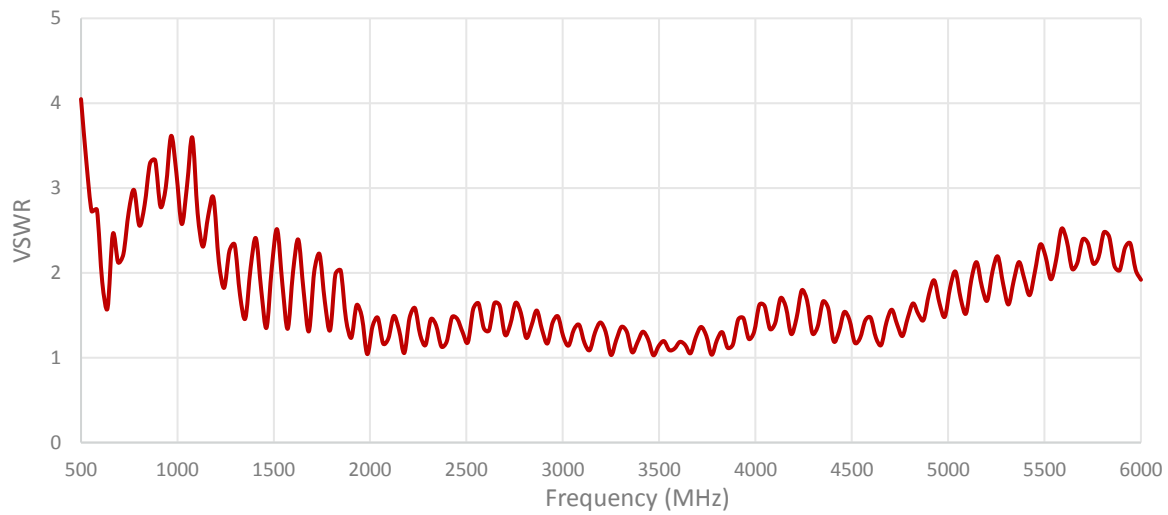
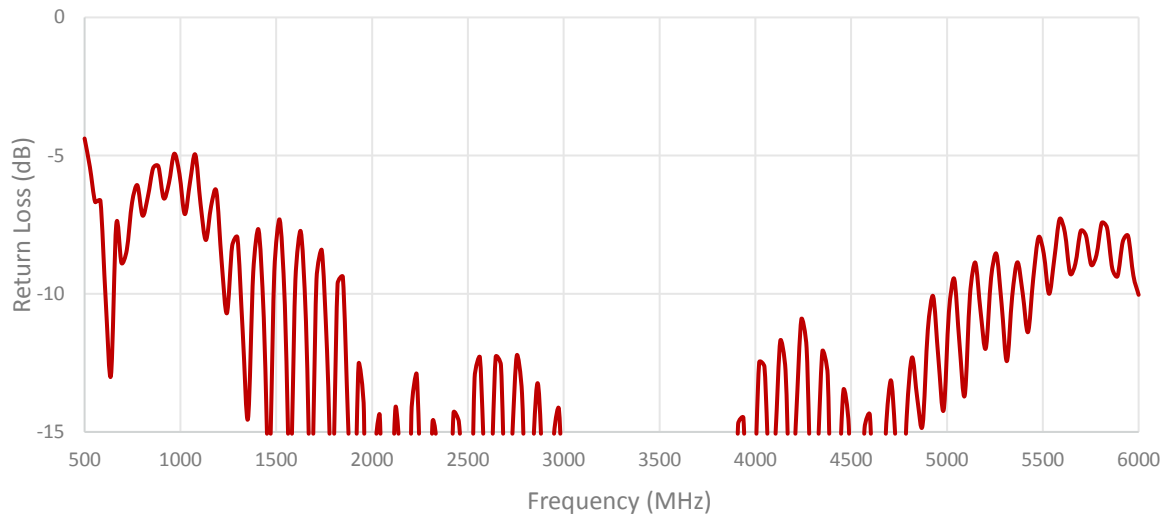

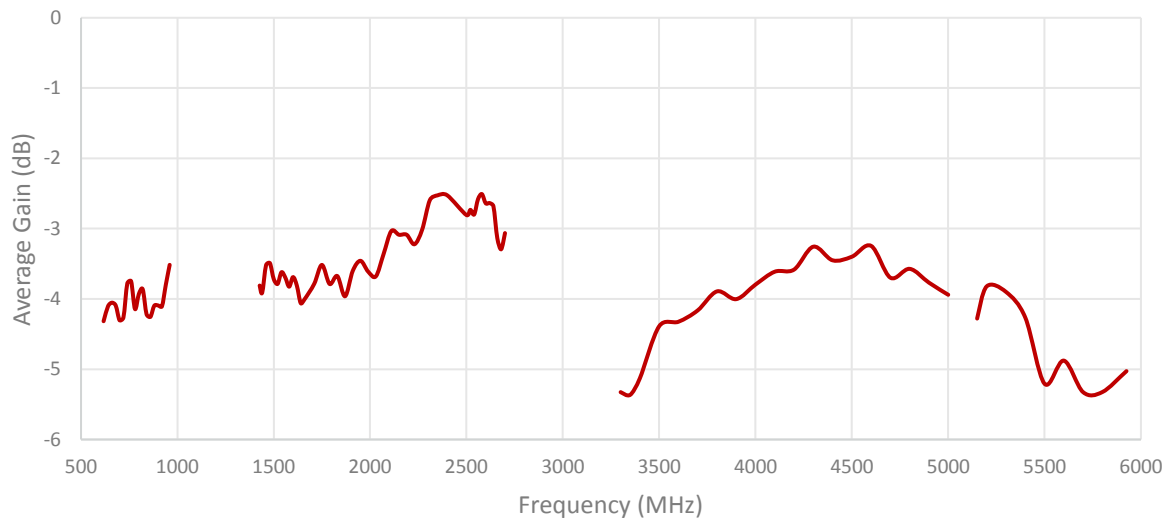
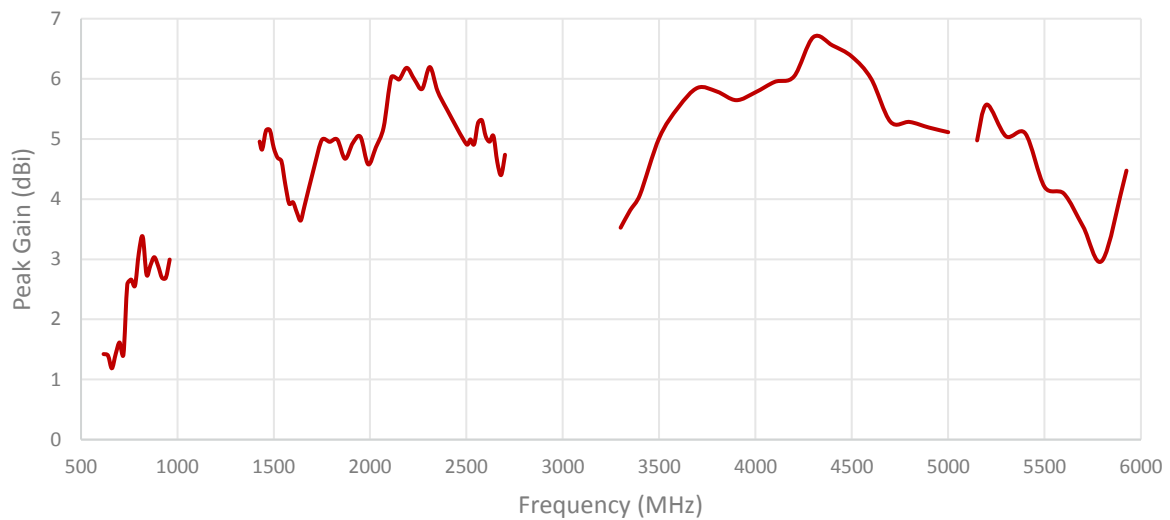
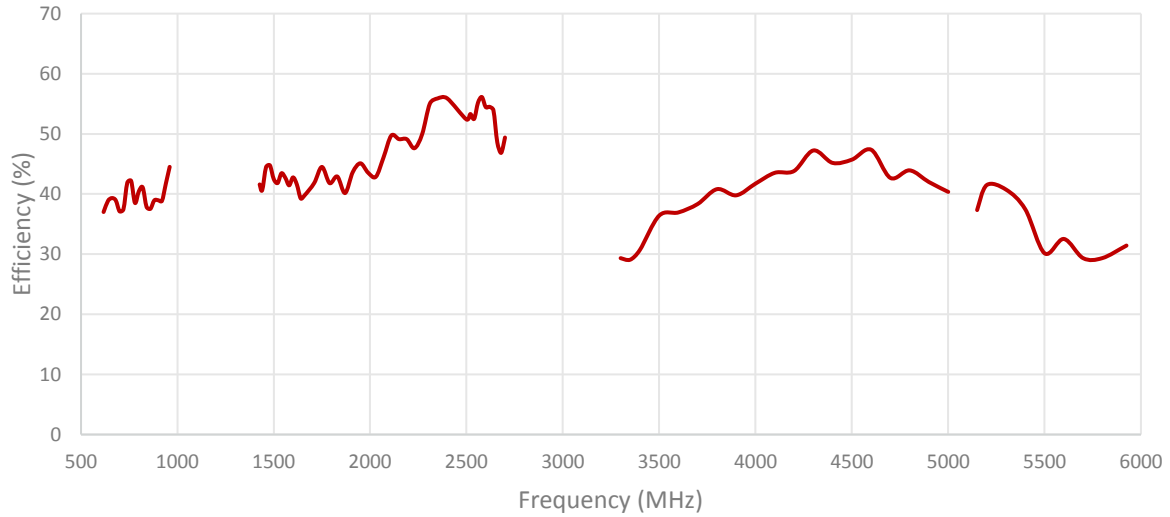

ISOLATION FOR CABLES 1 AND 2

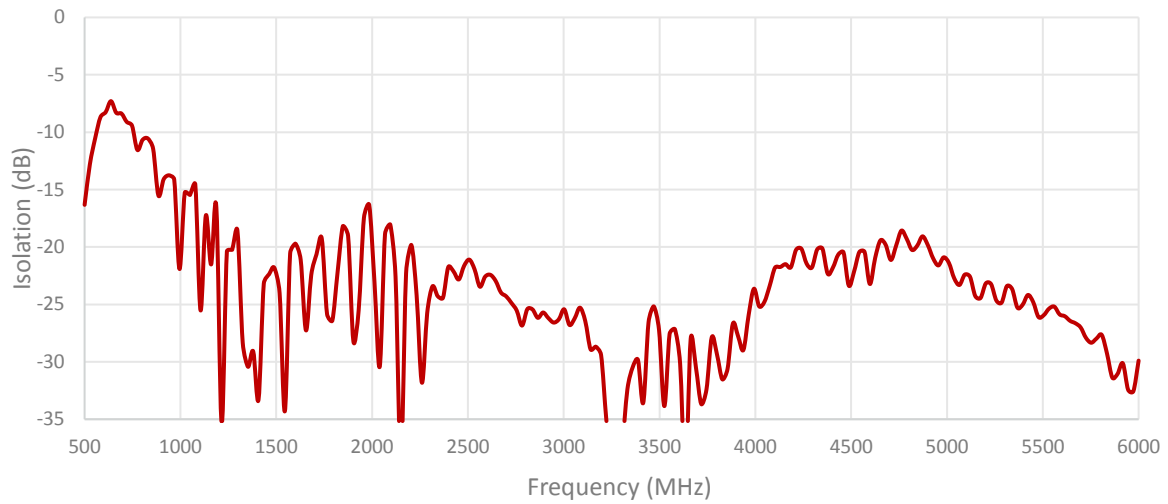

ENVELOPE CORRELATION COEFFICIENT FOR CABLES 1 AND 2

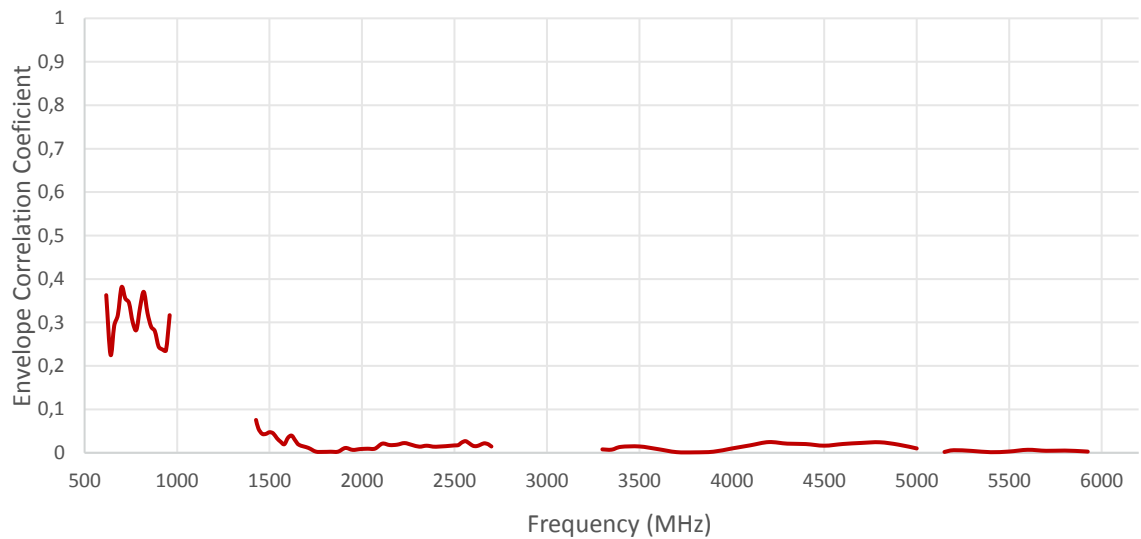

Cable 3: 2.4/5.0/6.0 GHz ISM

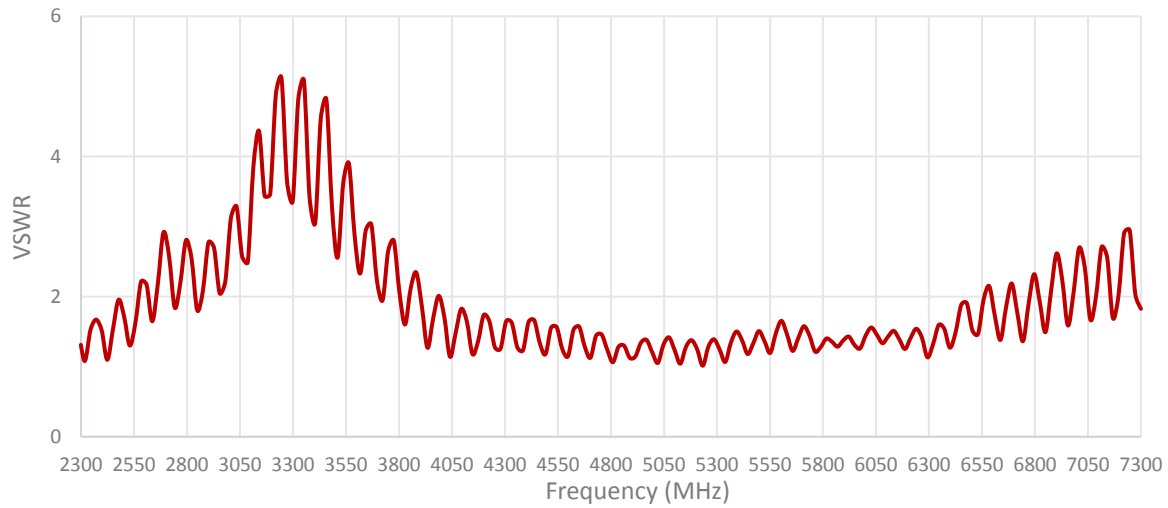
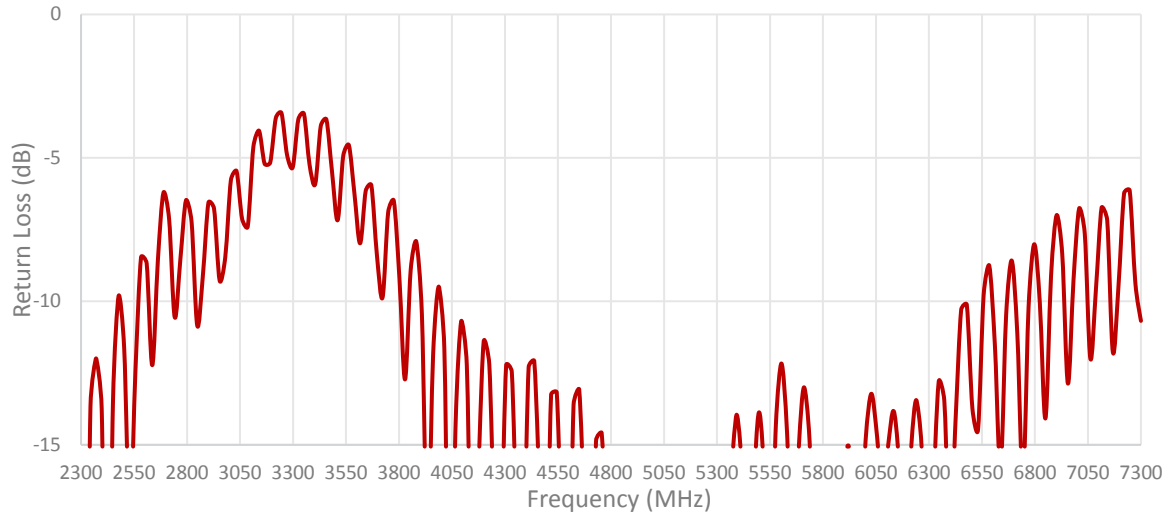

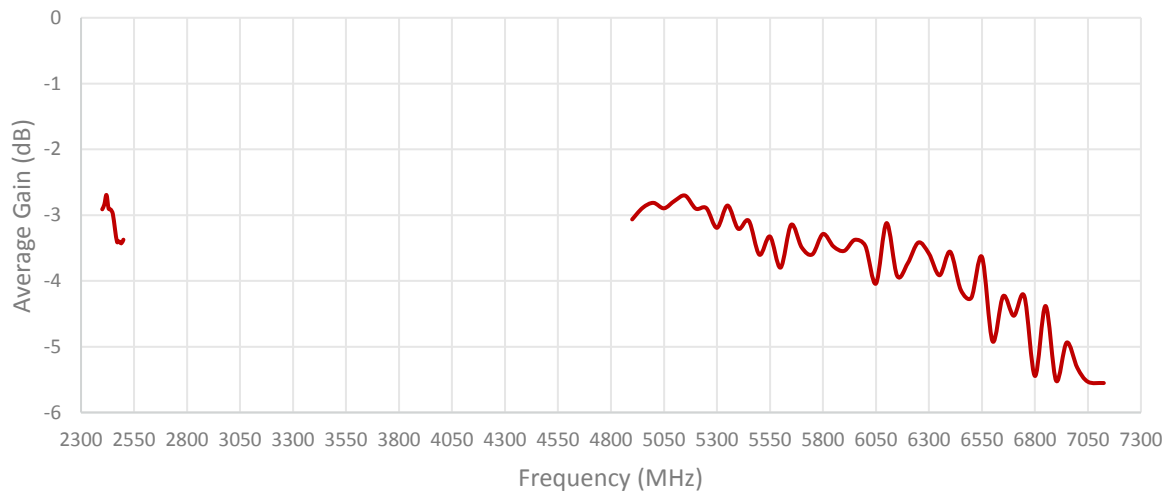
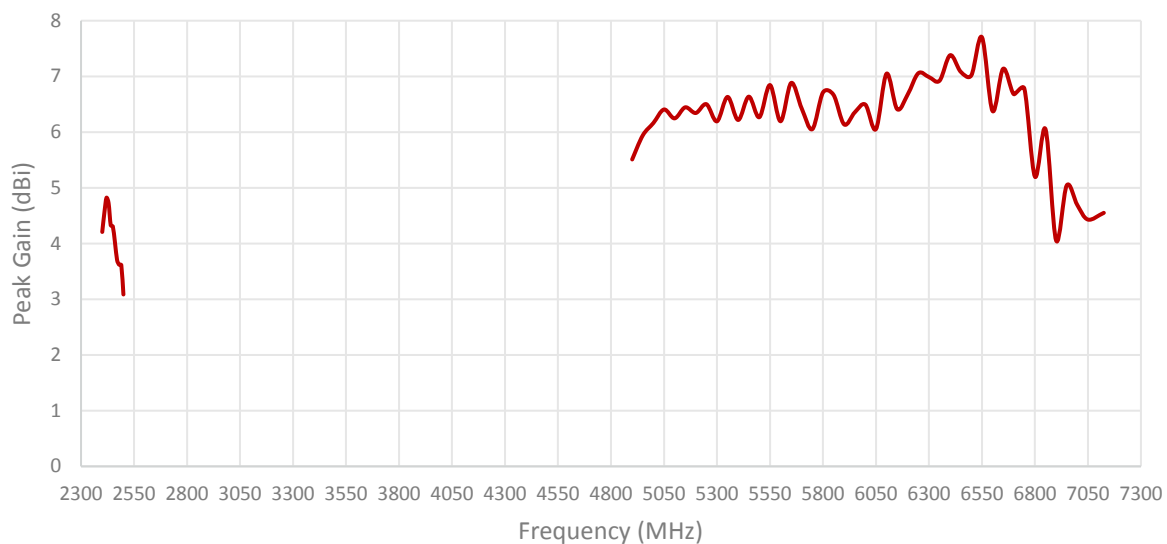
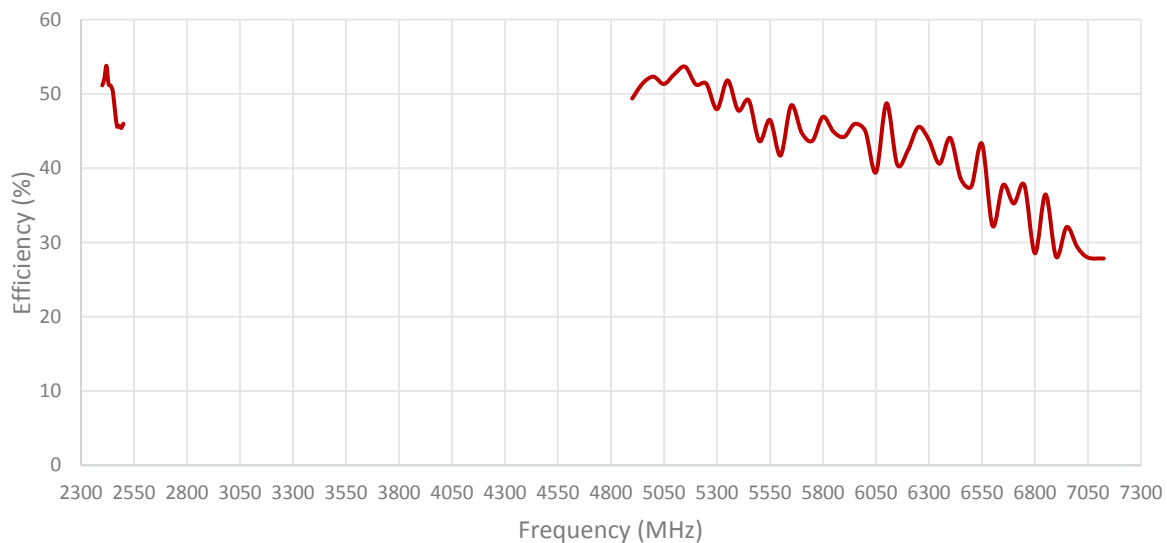
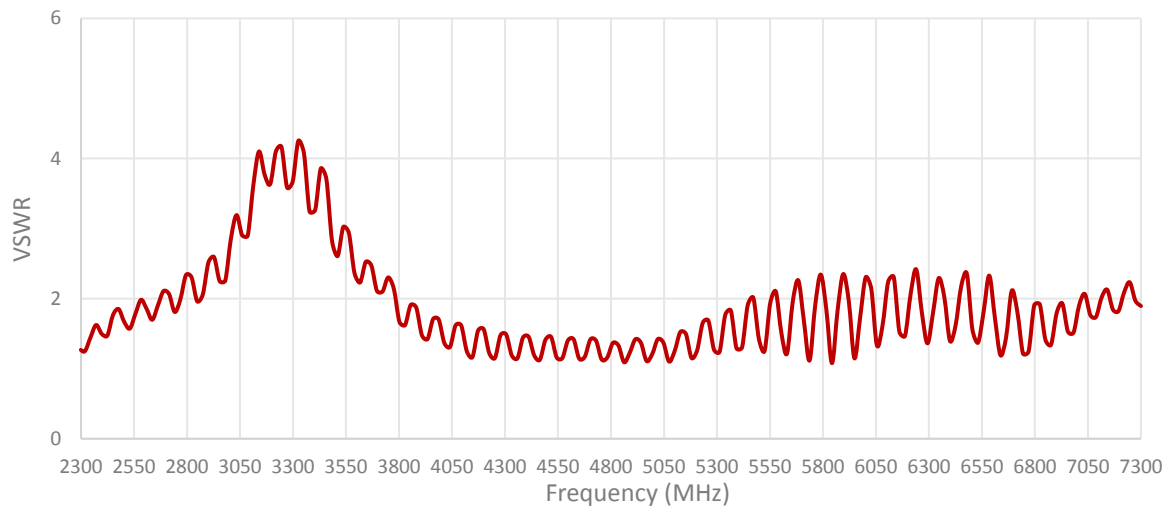
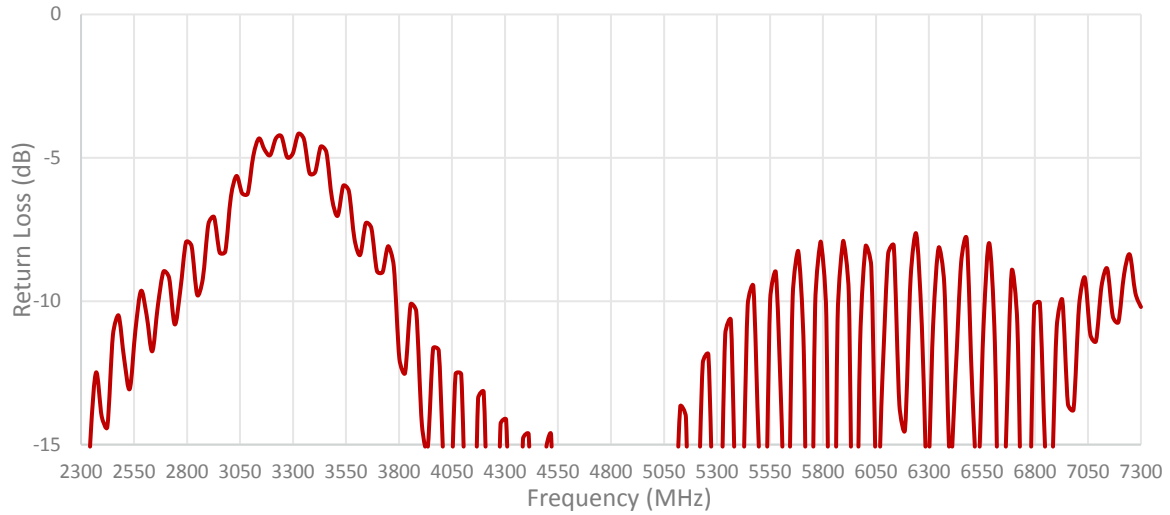
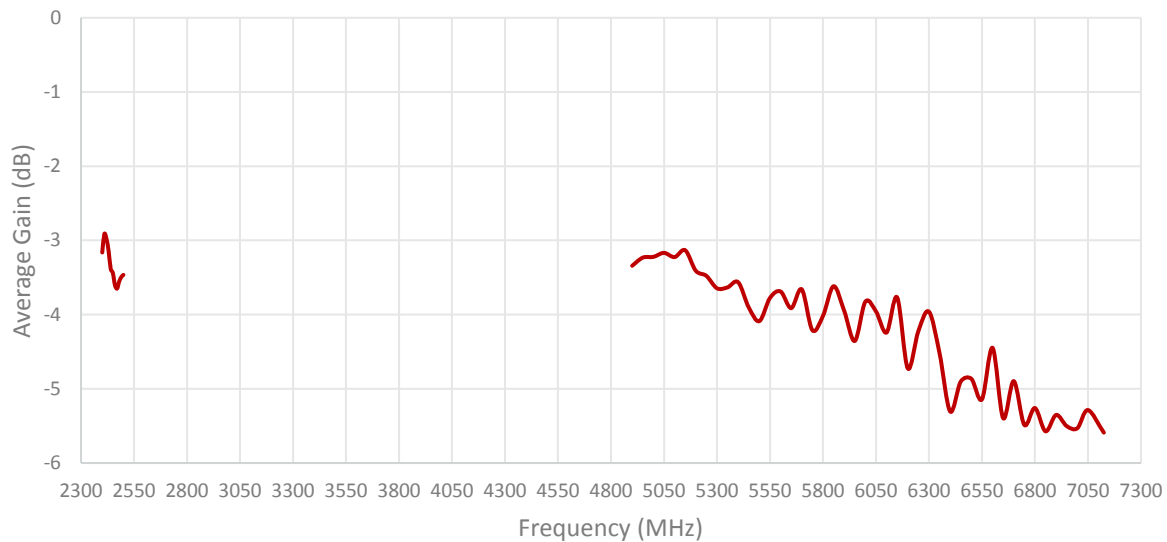
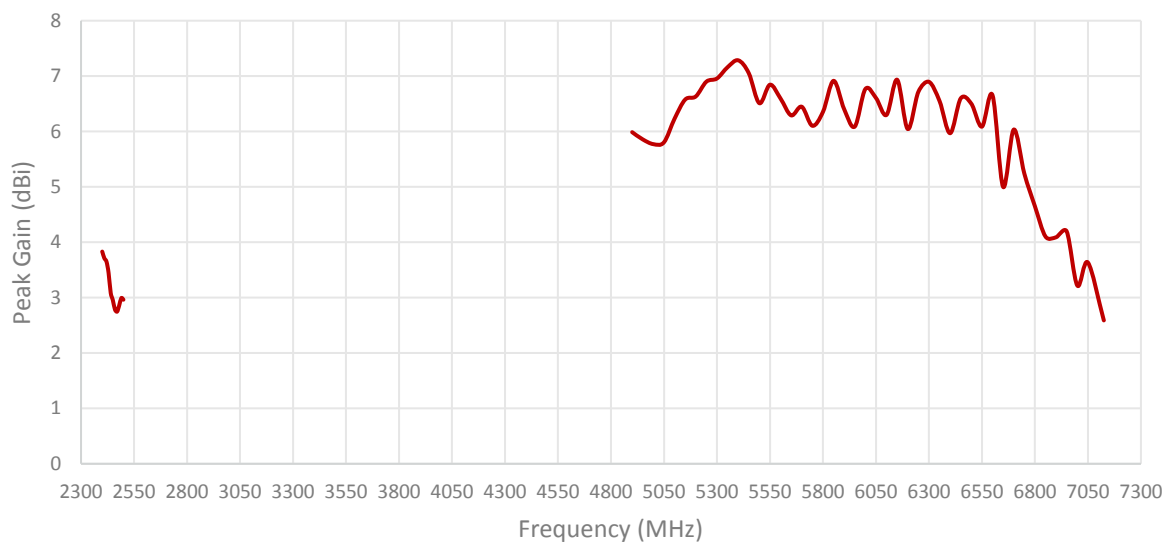
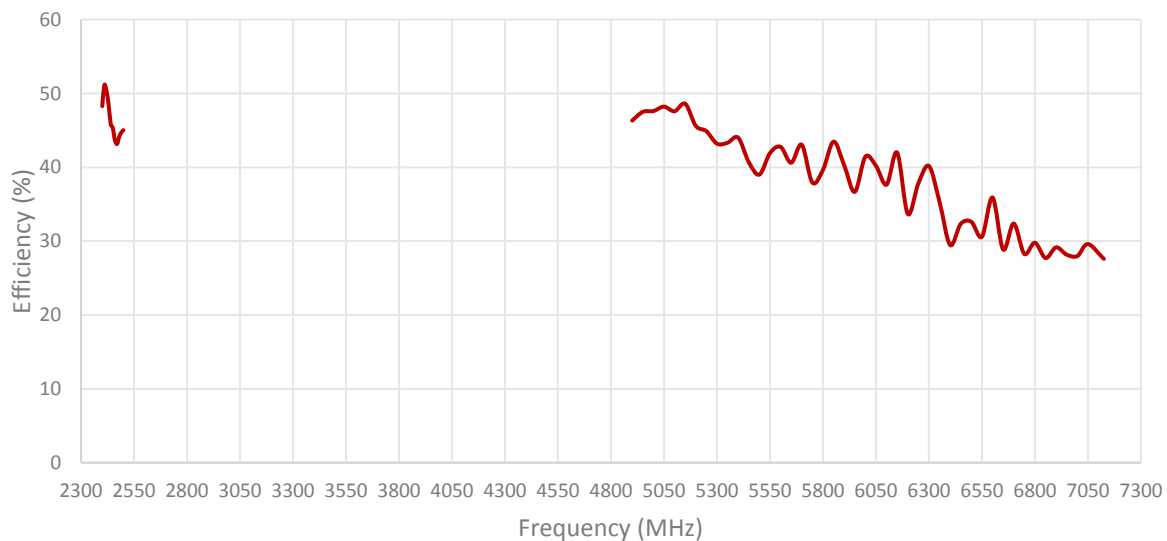
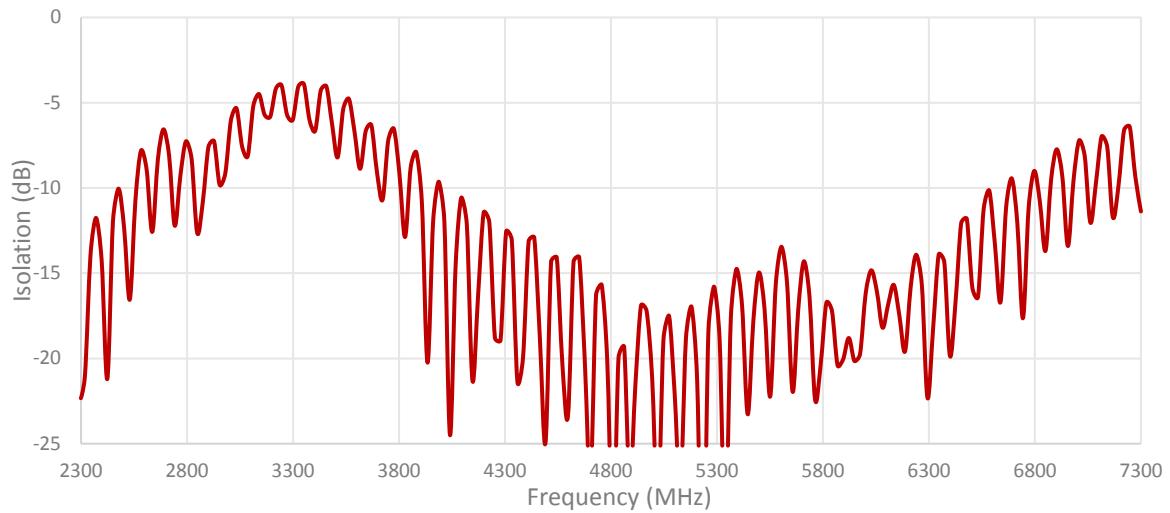

Table 4: 2.4/5.0/6.0 GHz ISM





ISOLATION FOR CABLES 3 AND 4



ENVELOPE CORRELATION COEFFICIENT FOR CABLES 3 AND 4

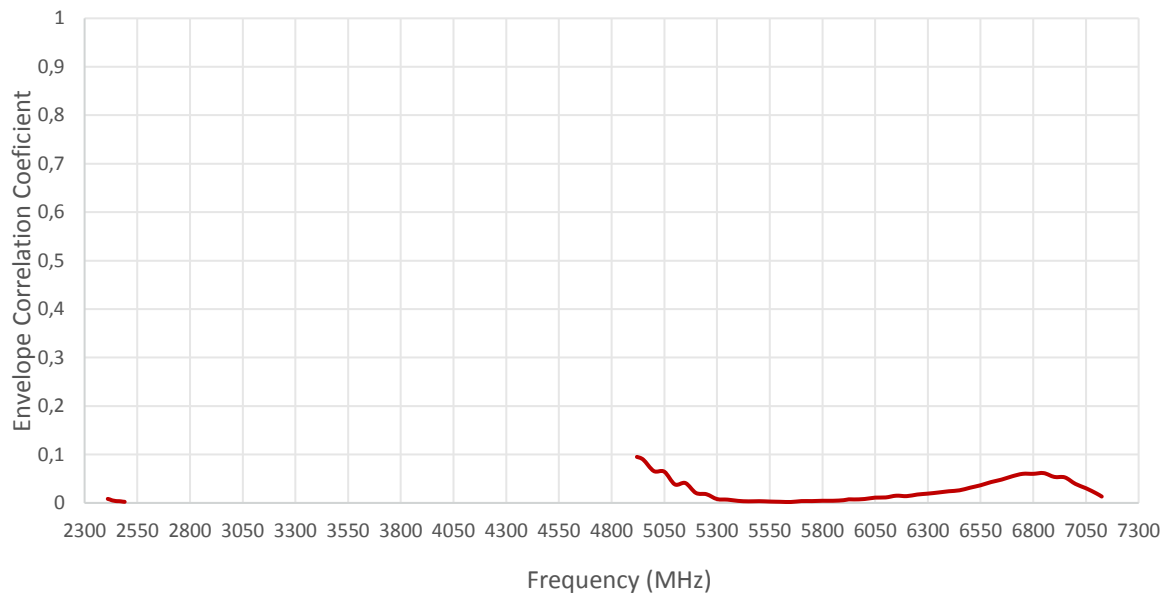

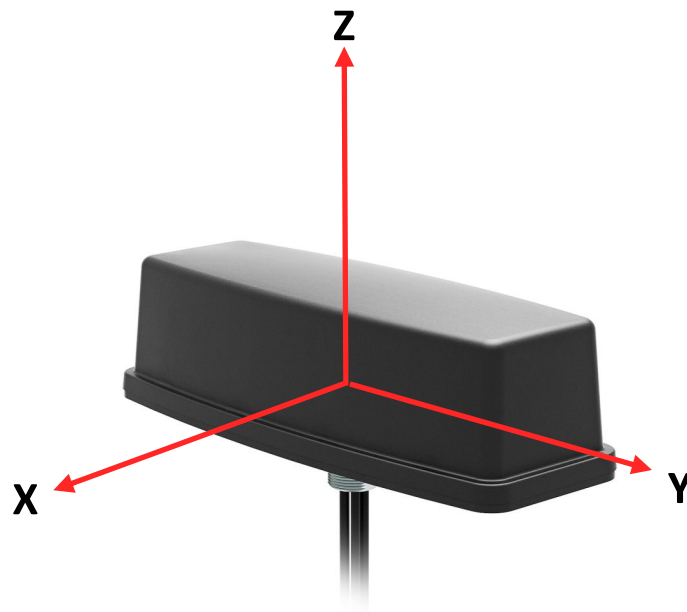

Radiation pattern reference

Cable 1: 5GNR

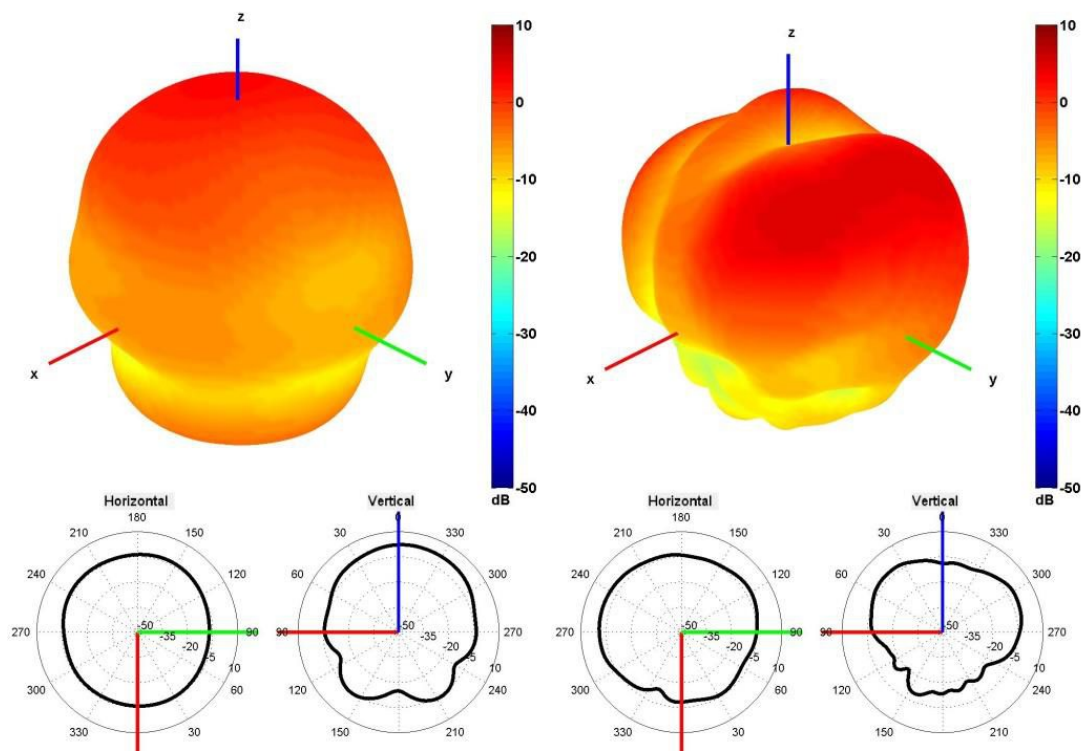

740 and 2500 MHz Radiation pattern

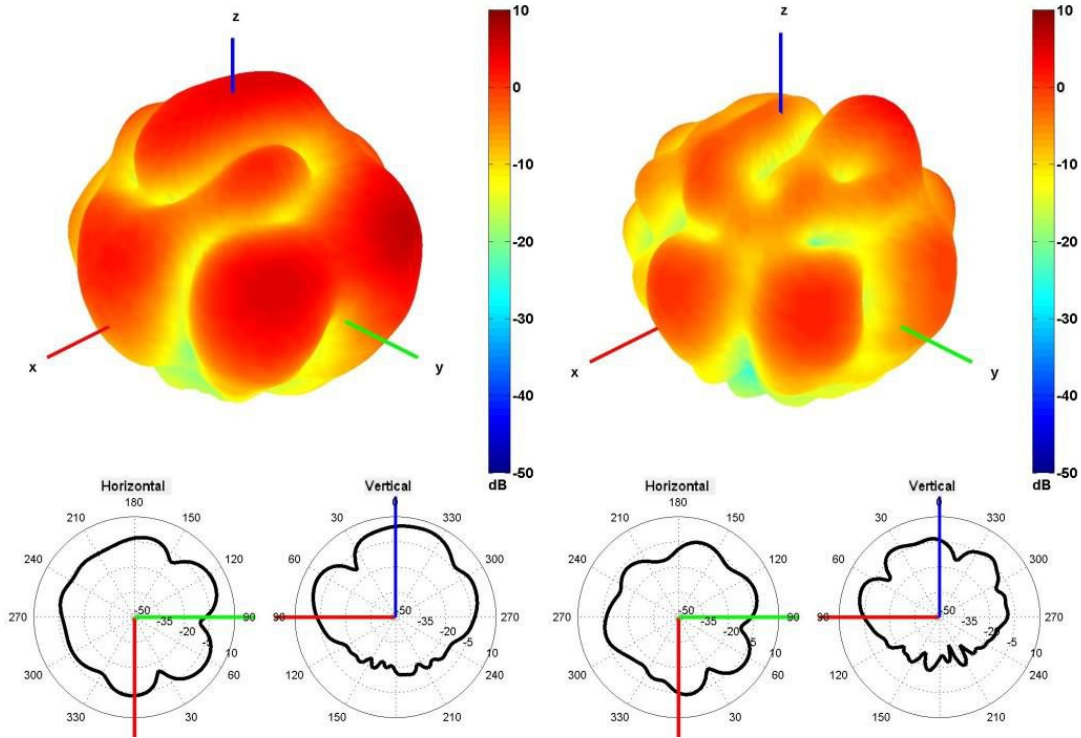

450 and 550 MHz Radiation pattern

Cable 2: 5GNR

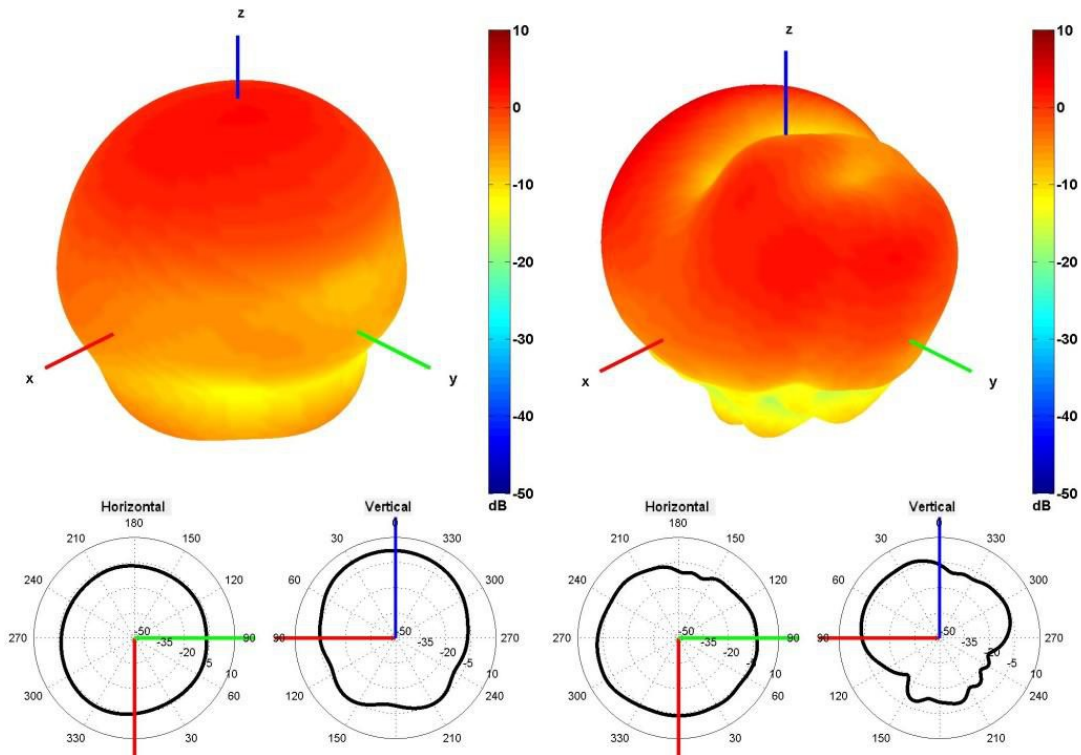

740 and 2500 MHz Radiation pattern

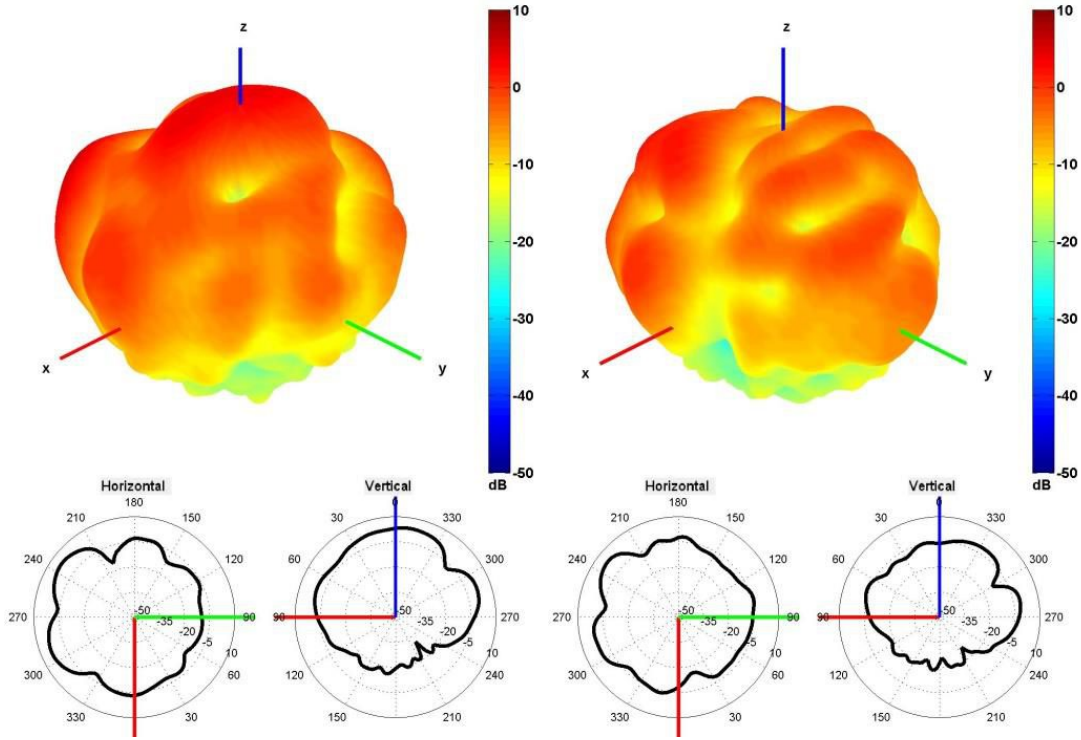

4500 and 5500 MHz Radiation pattern

Cable 3: 2.4/5.0/6.0 GHz ISM

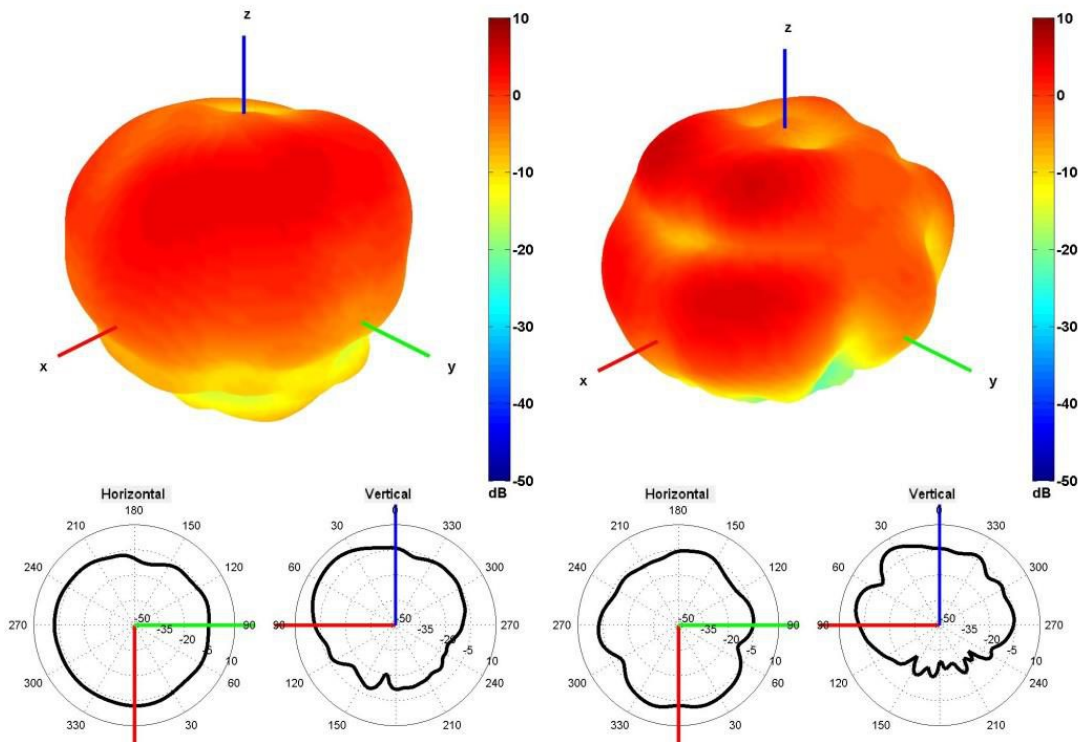

2450 and 5500 MHz Radiation pattern

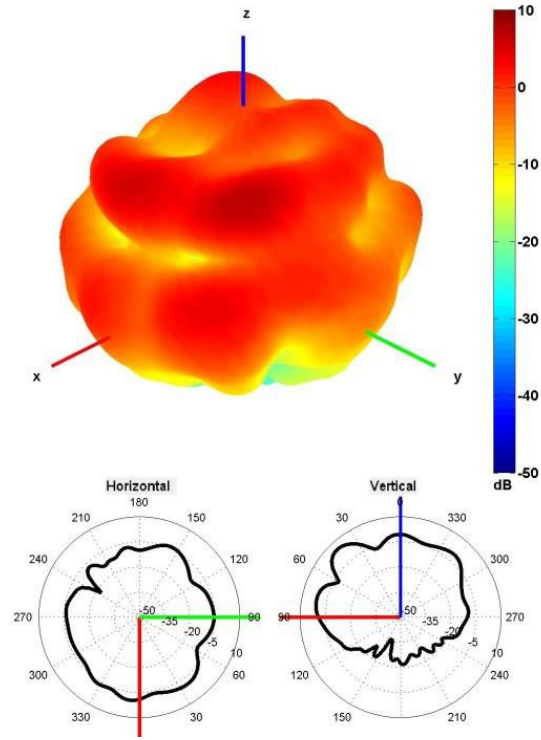

6500 MHz Radiation pattern

Cable 4: 2.4/5.0/6.0 GHz ISM

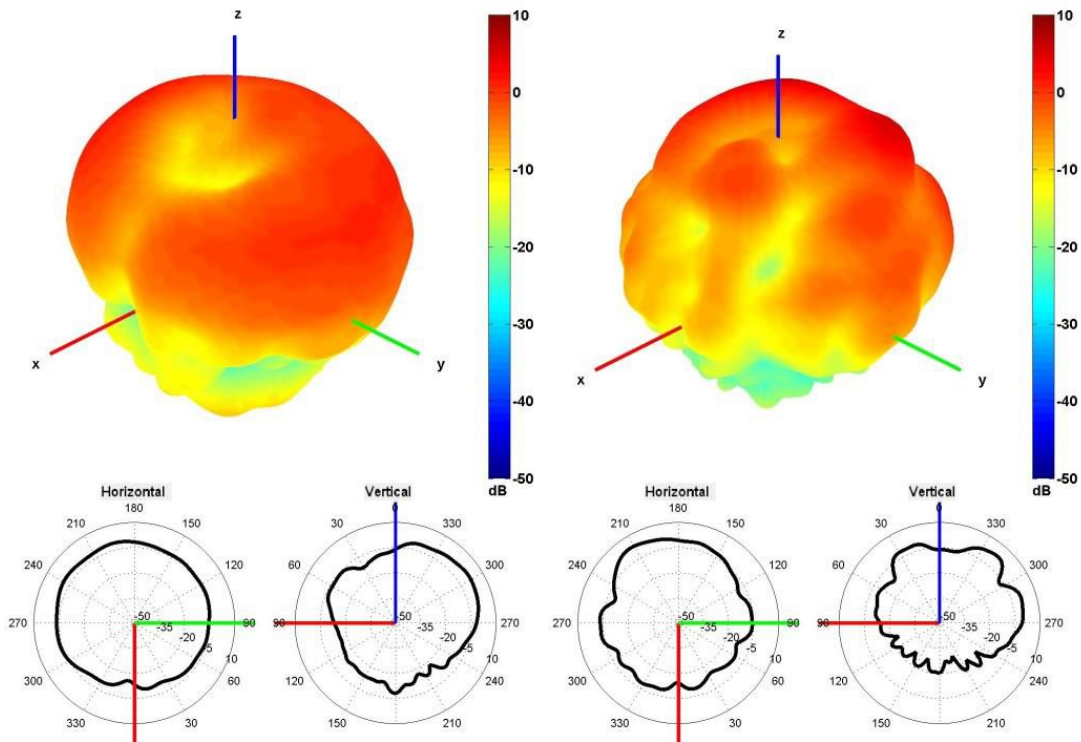

2450 and 5500 MHz Radiation pattern

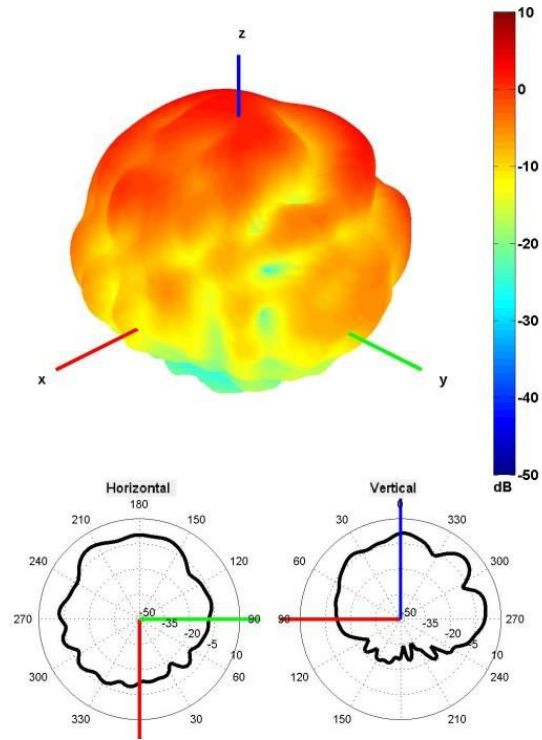

6500 MHz Radiation pattern

4. Antenna drawings

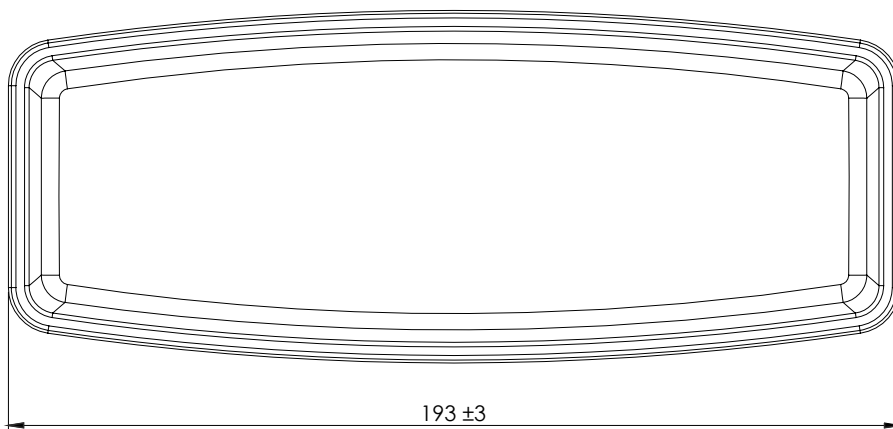
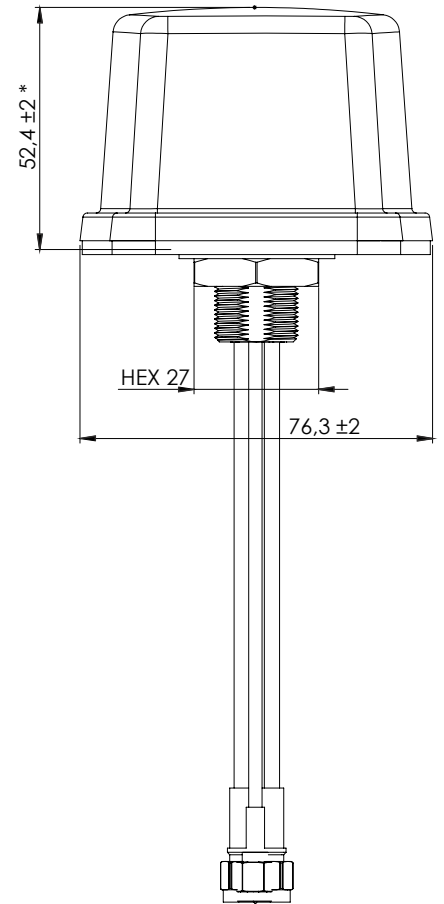
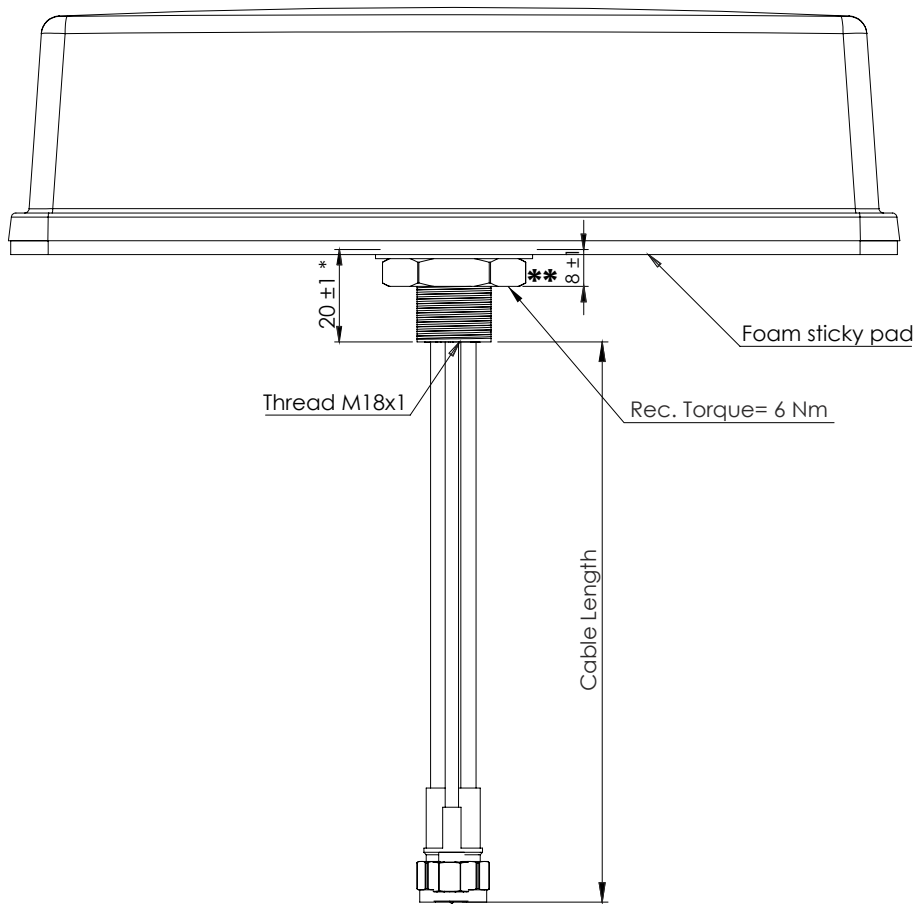

Mounting hole

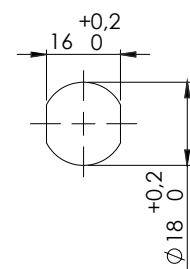

Max. mounting thickness 12mm
 Note: Dimensions are in millimeters
 *Dimensions are after mounting
 **Recommended Torque= 6 Nm

5. Antenna Images

