

2J6C02Mc

4× 2.4/5.0/6.0 GHz ISM MIMO Magnetic Mount

Key Features

Cable 1-4: 2.4/5.0/6.0 GHz ISM

- 2410-2490 MHz

- 4920-7125 MHz

Magnetic Mount

High Performance

Ground Plane Independent

Customizable Cable and Connector

Dimensions: 193 × 76.5 × 56.1 mm

Certificates: IP67, IP69

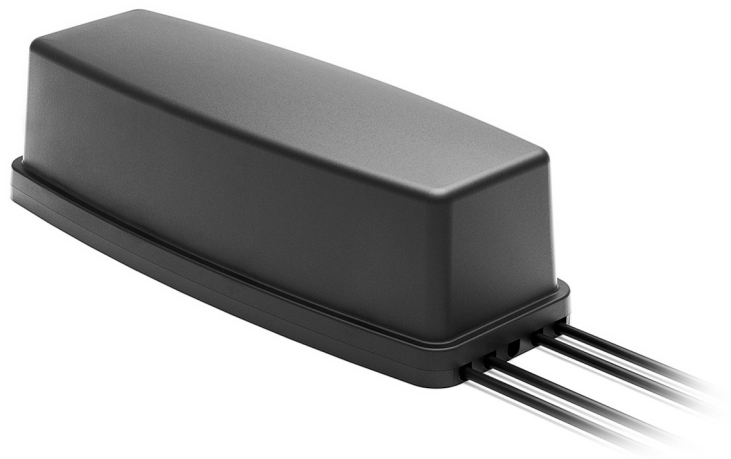

1. Antenna and electrical specifications

Cable 1

Parameters	2.4/5.0/6.0 GHz ISM Antenna		
Standards	WiFi, BT, ZigBee, ISM, Sigfox, LoRa		
Band (MHz)	2.4GHz	5.0 GHz	6.0GHz
Frequency (MHz)	2410-2490	4920-5925	5925-7125
Return Loss (dB)	~-13.7	~-19.2	~-17.5
VSWR	~1.6:1	~1.3:1	~1.4:1
Efficiency (%)	~63.7	~61.3	~48.1
Peak Gain (dBi)	~5.9	~6.3	~6.3
Average Gain (dB)	~-2.0	~-2.1	~-3.3
Impedance (Ohm)	50		
Polarisation	Linear		
Radiation Pattern	Omni-Directional		
Max. Input Power (W)	25		
Connector Type	SMA-Male-RP Standard (Other Connectors Available)		
Cable Length	300 cm Standard (Any Cable Length Available)		
Cable Type	LL195 Standard (Other Cables Available)		

Cable 2

Parameters	2.4/5.0/6.0 GHz ISM Antenna		
Standards	WiFi, BT, ZigBee, ISM, Sigfox, LoRa		
Band (MHz)	2.4 GHz	5.0 GHz	6.0 GHz
Frequency (MHz)	2410-2490	4920-5925	5925-7125
Return Loss (dB)	~-14.9	~-15.8	~-14.2
VSWR	~1.5:1	~1.4:1	~1.6:1
Efficiency (%)	~63.2	~62.1	~48.7
Peak Gain (dBi)	~4.8	~6.3	~6.4
Average Gain (dB)	~-2.0	~-2.1	~-3.1
Impedance (Ohm)	50		
Polarisation	Linear		
Radiation Pattern	Omni-Directional		
Max. Input Power (W)	25		
Connector Type	SMA-Male-RP Standard (Other Connectors Available)		
Cable Length	300 cm Standard (Any Cable Length Available)		
Cable Type	LL195 Standard (Other Cables Available)		

Cable 3

Parameters	2.4/5.0/6.0 GHz ISM Antenna		
Standards	WiFi, BT, ZigBee, ISM, Sigfox, LoRa		
Band (MHz)	2.4GHz	5.0 GHz	6.0GHz
Frequency (MHz)	2410-2490	4920-5925	5925-7125
Return Loss (dB)	~-13.0	~-10.1	~-14.1
VSWR	~1.6:1	~1.9:1	~1.6:1
Efficiency (%)	~61.8	~52.0	~52.1
Peak Gain (dBi)	~4.4	~6.3	~7.1
Average Gain (dB)	~-2.1	~-2.9	~-2.8
Impedance (Ohm)	50		
Polarisation	Linear		
Radiation Pattern	Omni-Directional		
Max. Input Power (W)	25		
Connector Type	SMA-Male-RP Standard (Other Connectors Available)		
Cable Length	300 cm Standard (Any Cable Length Available)		
Cable Type	LL195 Standard (Other Cables Available)		

Cable 4

Parameters	2.4/5.0/6.0 GHz ISM Antenna		
Standards	WiFi, BT, ZigBee, ISM, Sigfox, LoRa		
Band (MHz)	2.4 GHz	5.0 GHz	6.0 GHz
Frequency (MHz)	2410-2490	4920-5925	5925-7125
Return Loss (dB)	~-10.8	~-12.0	~-14.2
VSWR	~1.9:1	~1.7:1	~1.6:1
Efficiency (%)	~62.4	~55.0	~45.0
Peak Gain (dBi)	~4.3	~6.3	~5.6
Average Gain (dB)	~-2.1	~-2.6	~-3.8
Impedance (Ohm)	50		
Polarisation	Linear		
Radiation Pattern	Omni-Directional		
Max. Input Power (W)	25		
Connector Type	SMA-Male-RP Standard (Other Connectors Available)		
Cable Length	300 cm Standard (Any Cable Length Available)		
Cable Type	LL195 Standard (Other Cables Available)		

Antenna Measurement Conditions:

Mounted on Metal Plate of 30 x 30 cm
 100 cm of Cable LL195
 Measured in Certified CTIA 3D Anechoic Chamber

2. Mechanical and environmental specifications

Specifications	2J6C02Mc
Mounting Type	Magnetic Mount
Dimensions (mm)	193 × 76.5 × 56.1
Radome Type	ASA
Radome color	Black, White
Operating Temperature (C)	-40 to +85
Storage Temperature (C)	-40 to +85
Substance Compliance	RoHS
Certificates	IP67, IP69

3. Antenna parameters

Cable 1: 2.4/5.0/6.0 GHz ISM

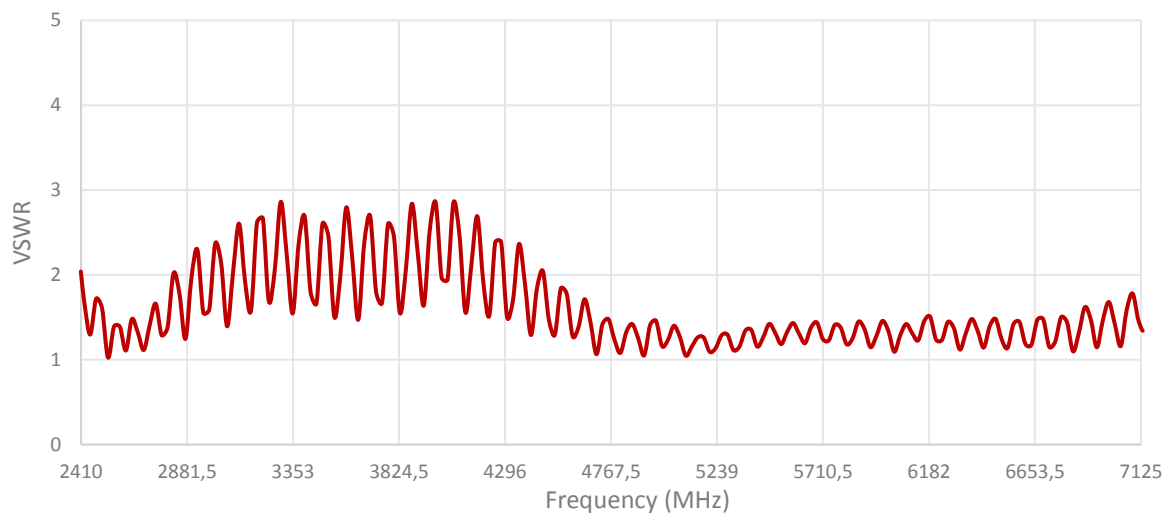
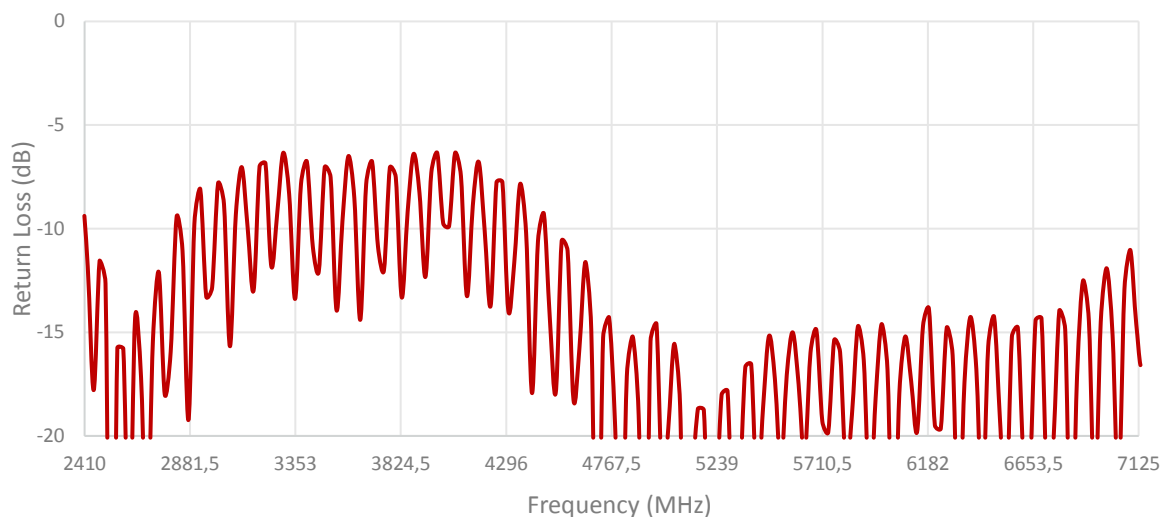

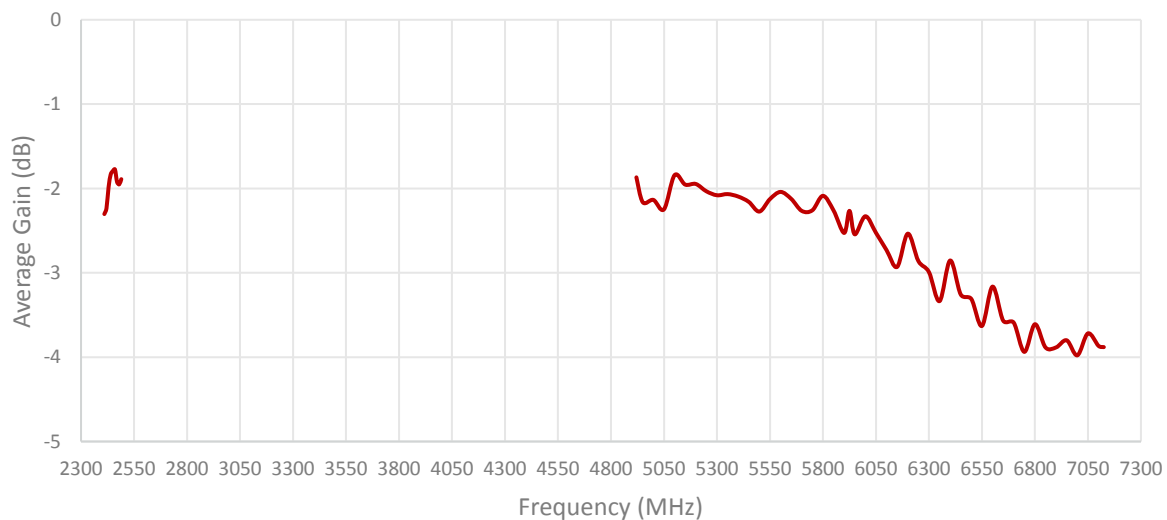
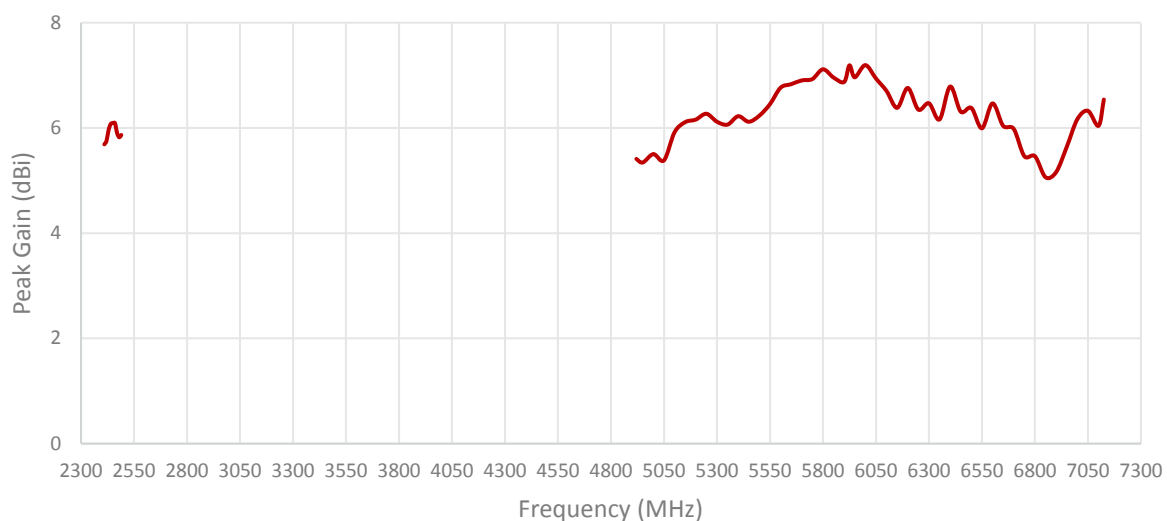
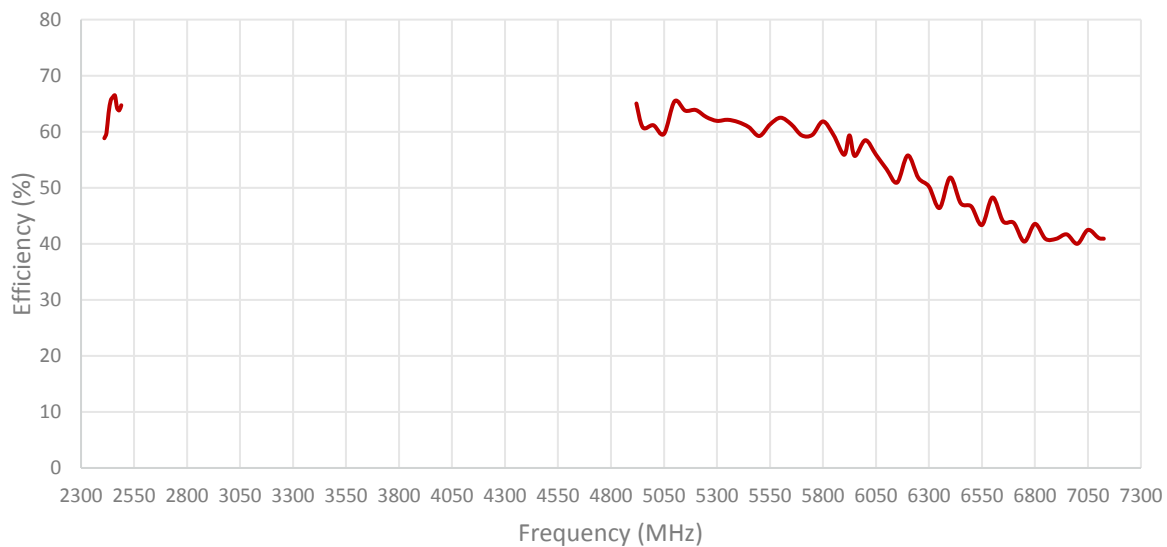
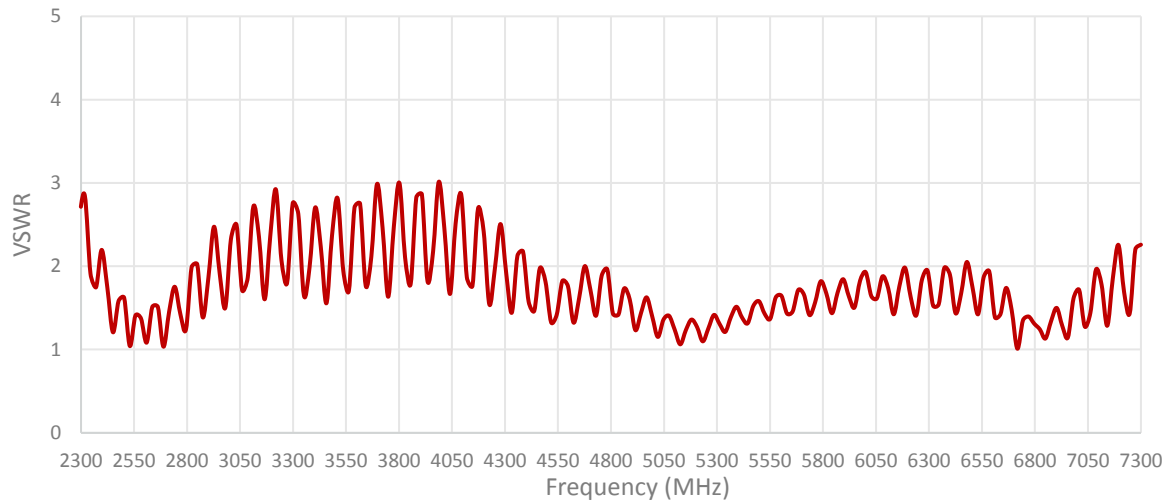
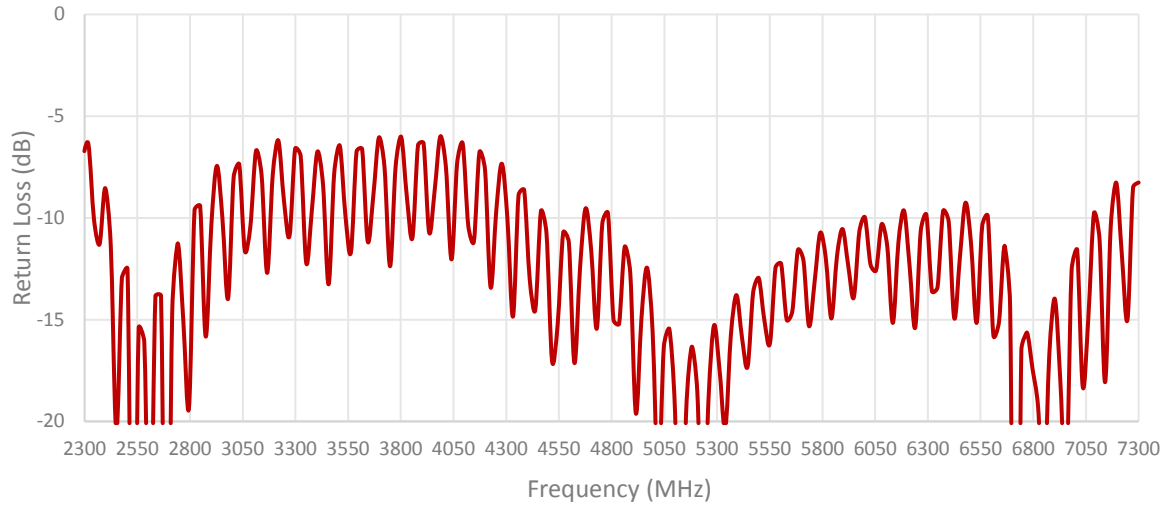

Table 2: 2.4/5.0/6.0 GHz ISM



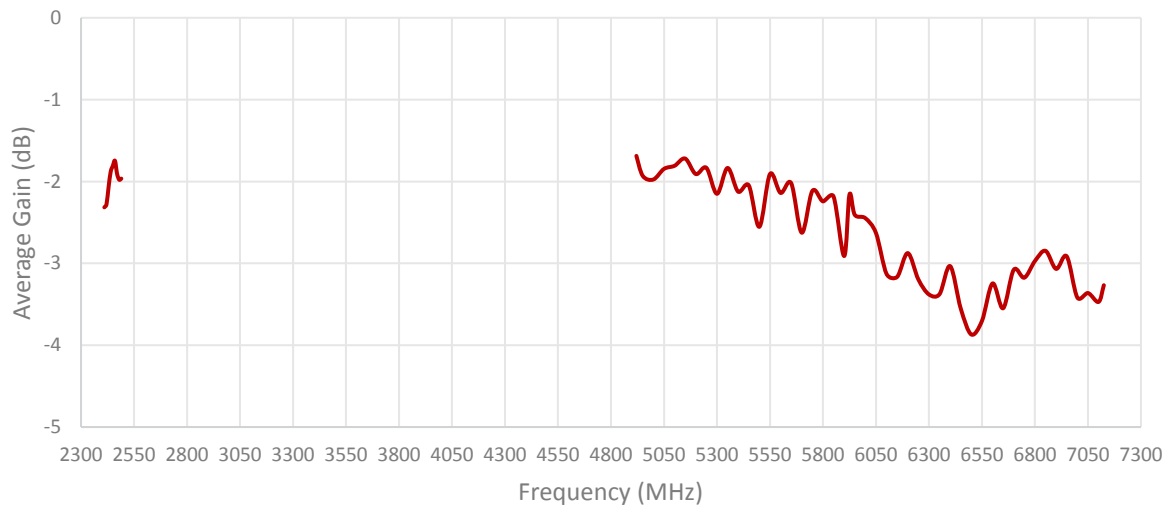
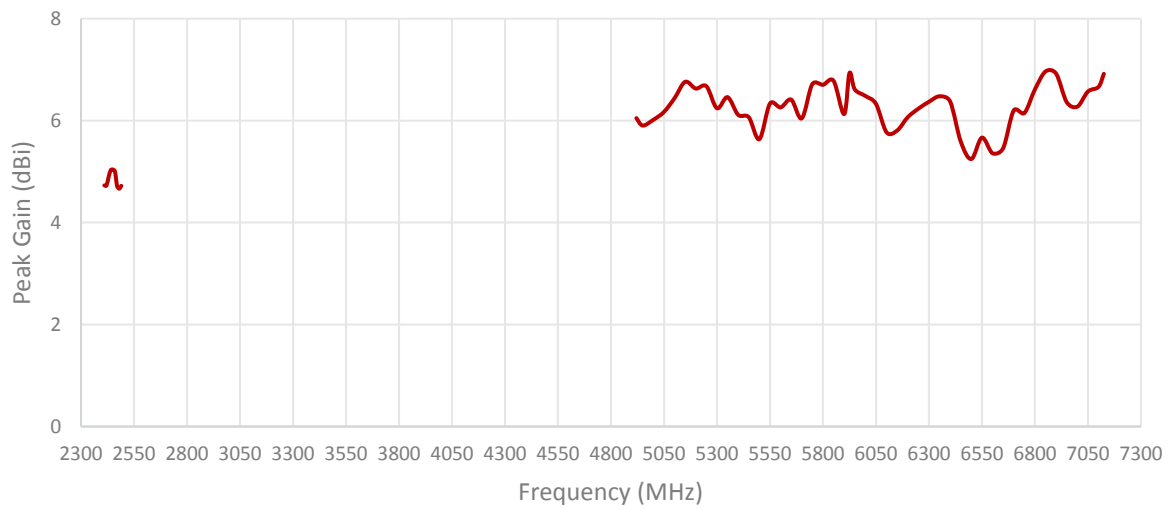
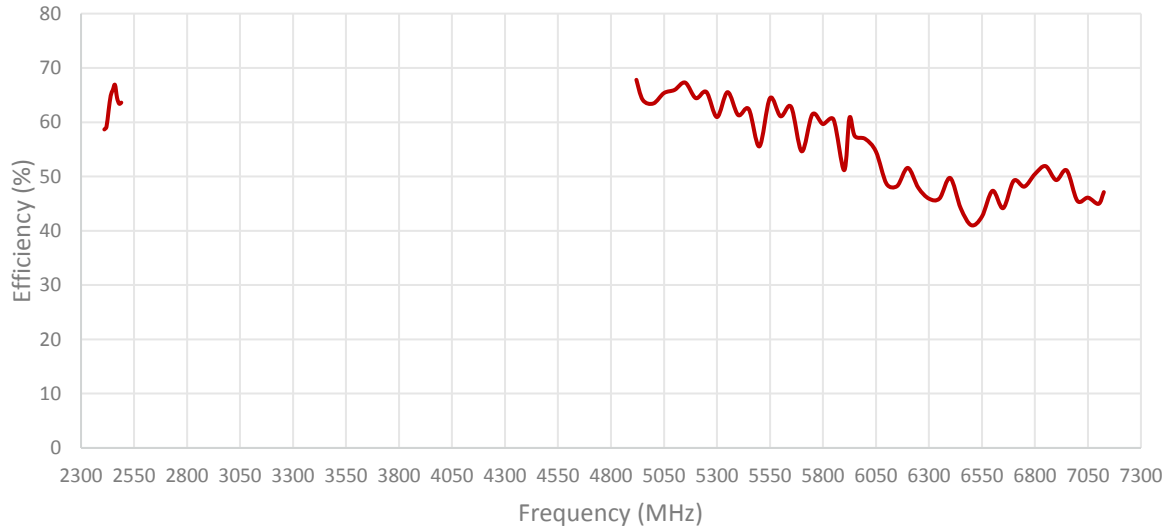
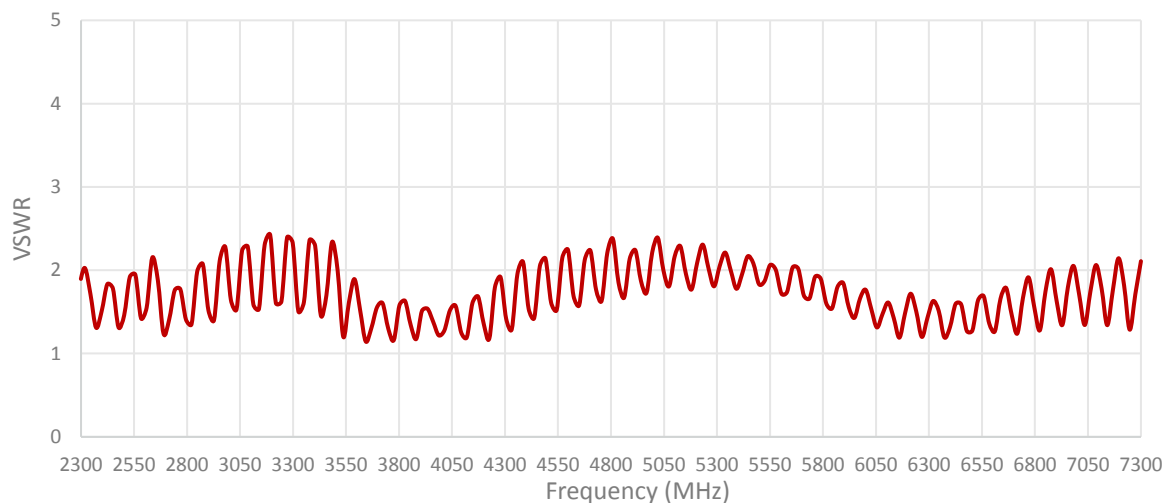
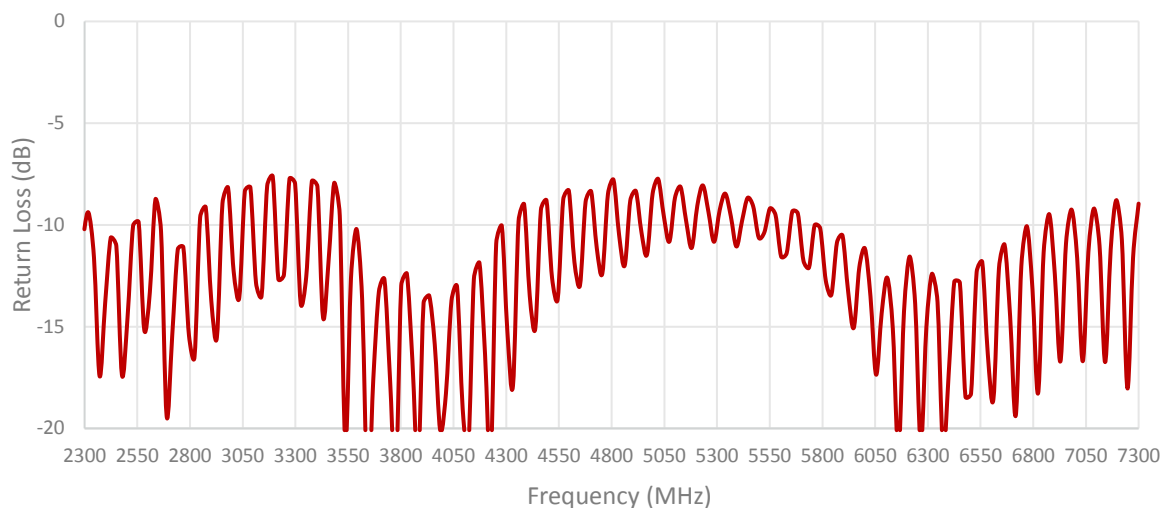

Table 3: 2.4/5.0/6.0 GHz ISM



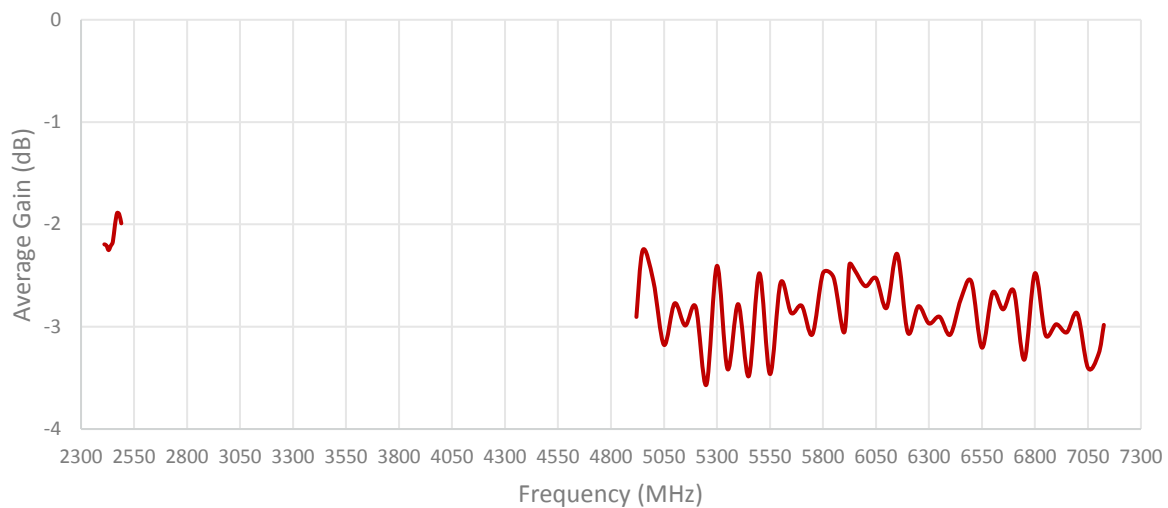
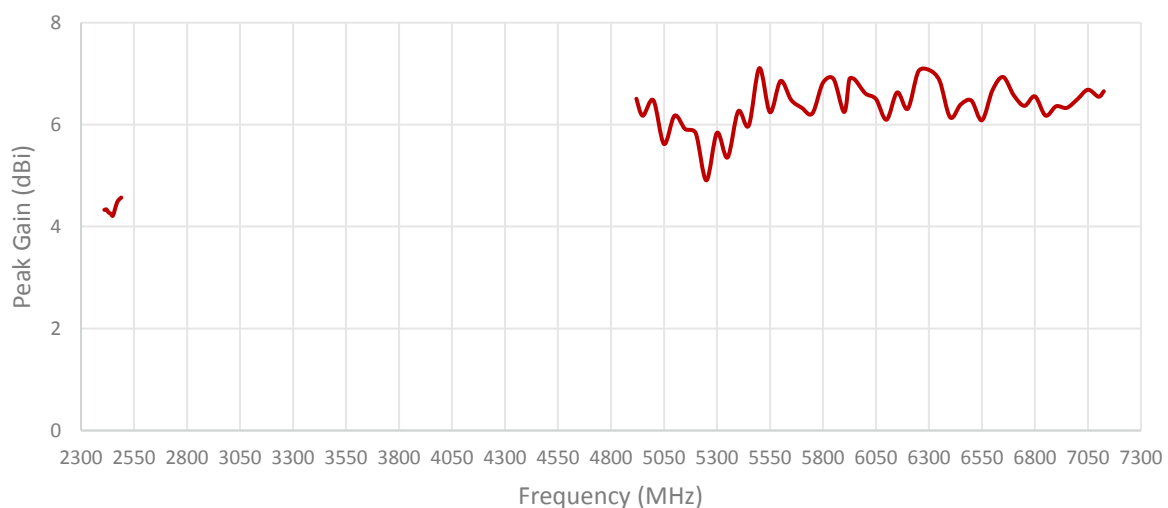
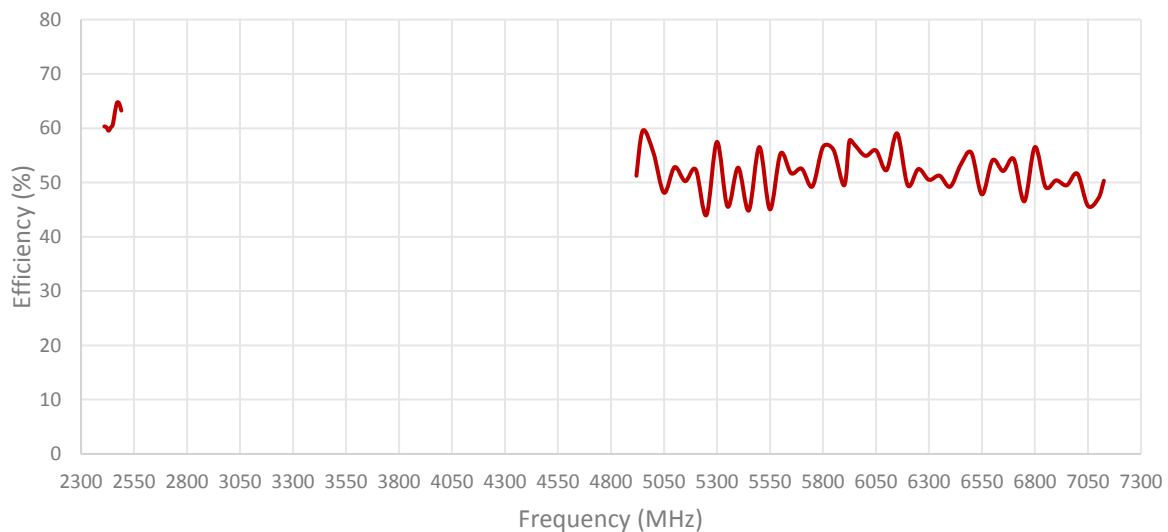
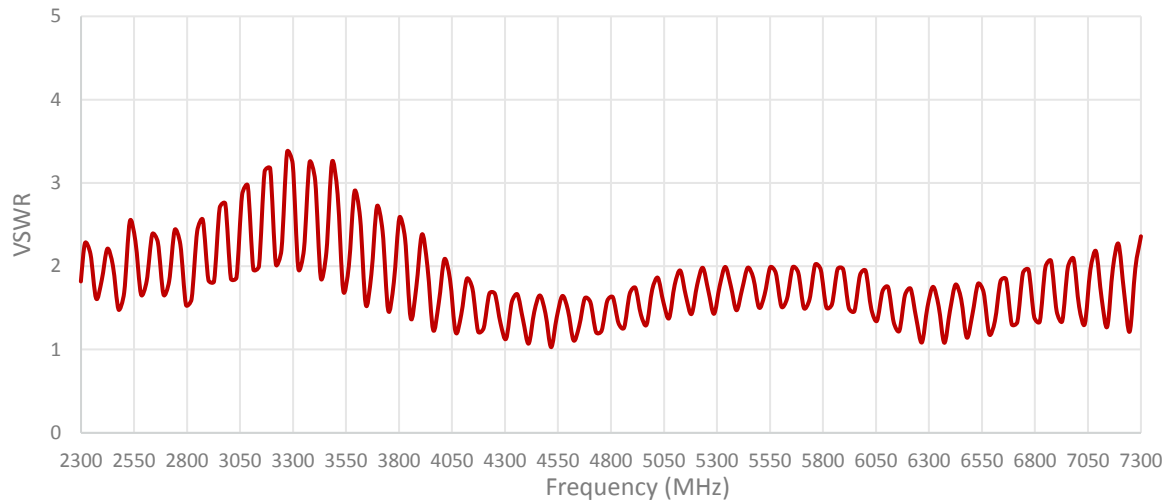
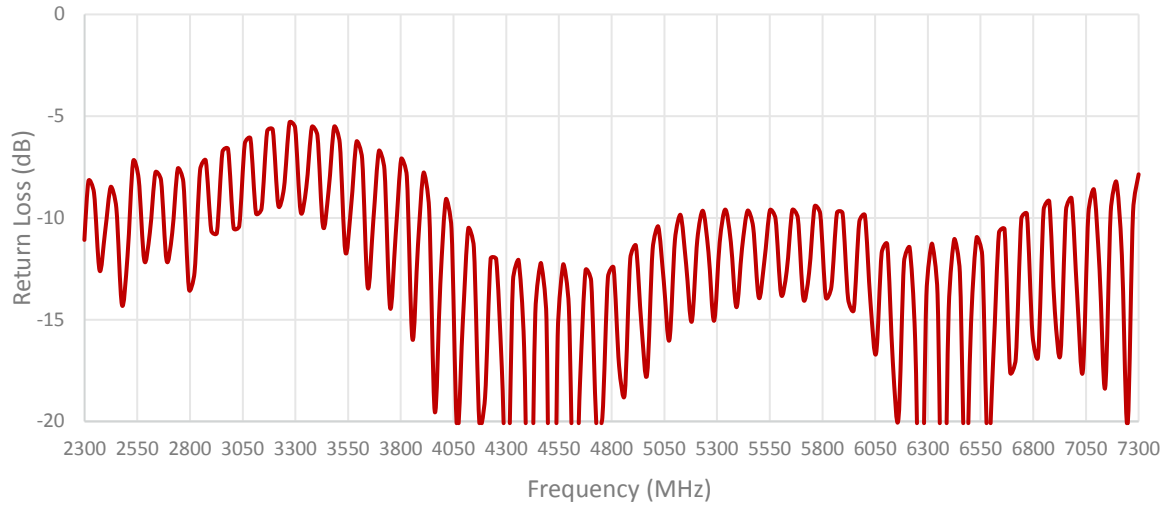
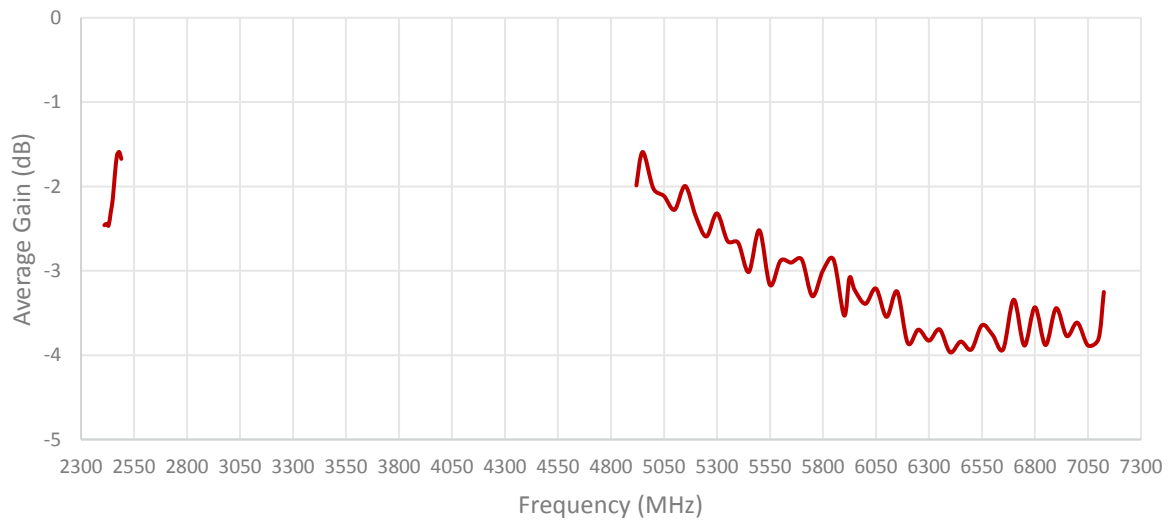
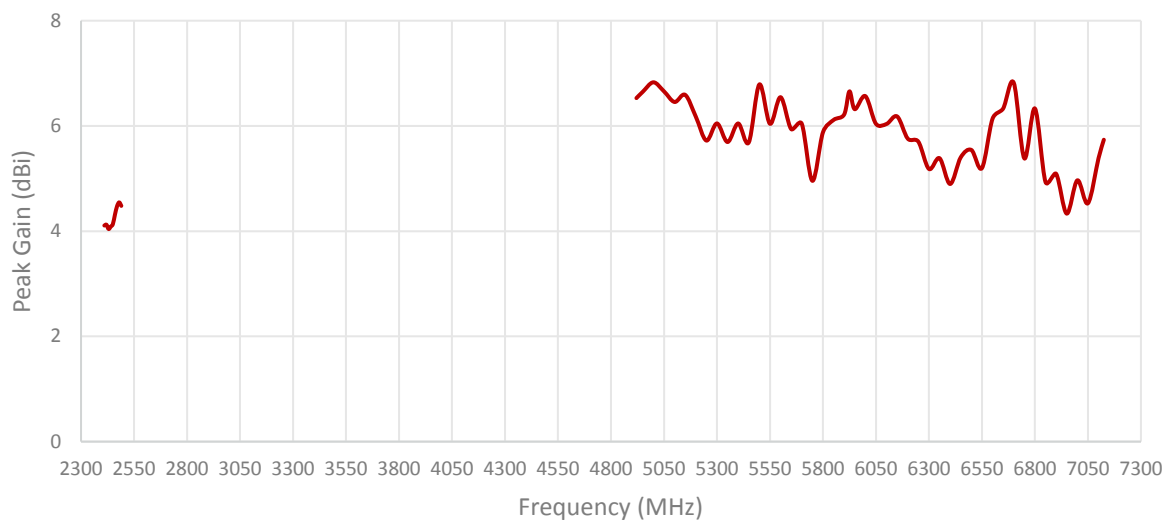
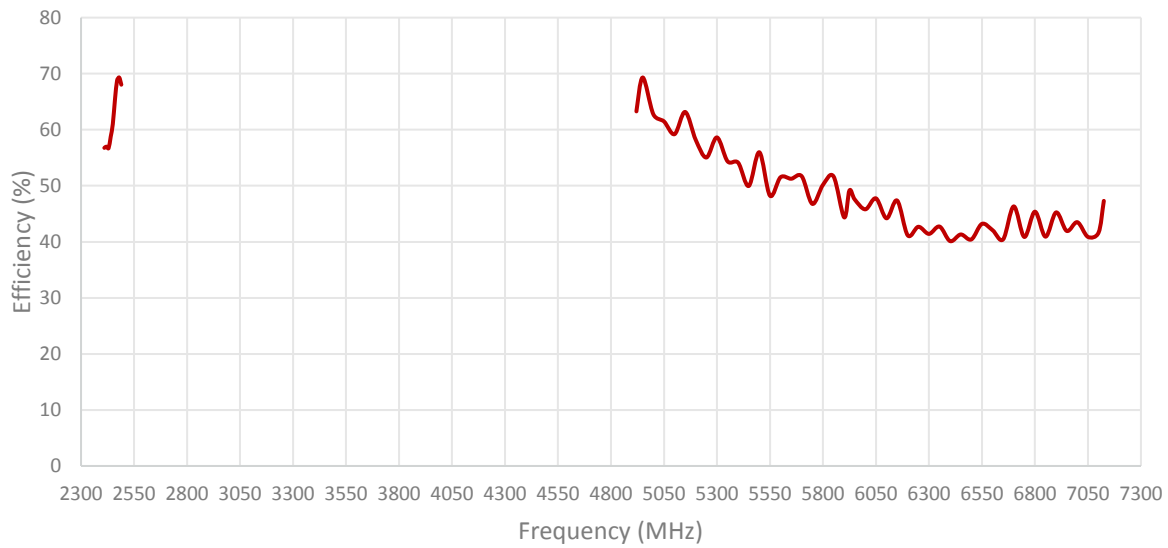
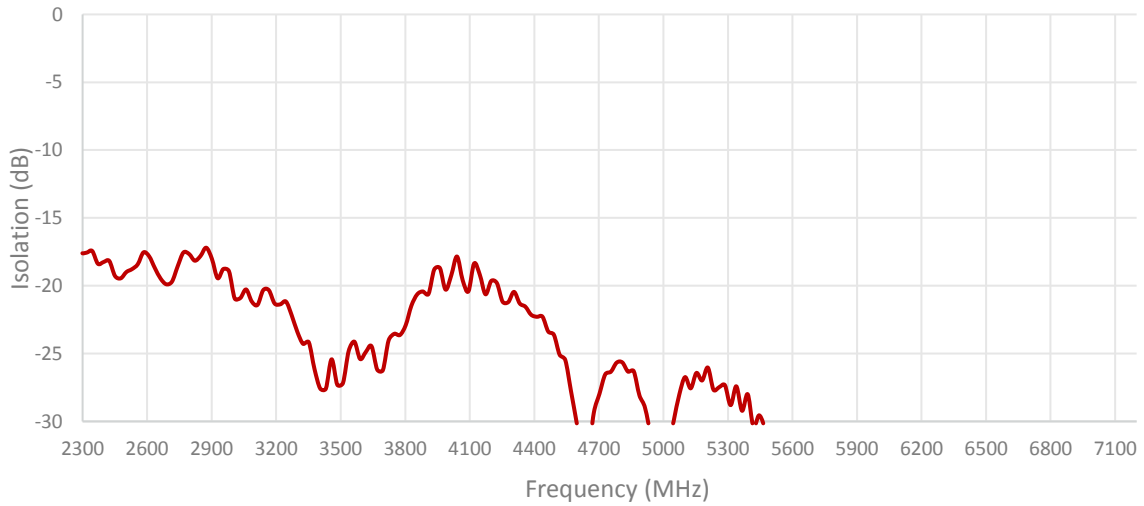

Table 4: 2.4/5.0/6.0 GHz ISM





ISOLATION FOR CABLES 1 AND 2



ISOLATION FOR CABLES 1 AND 3

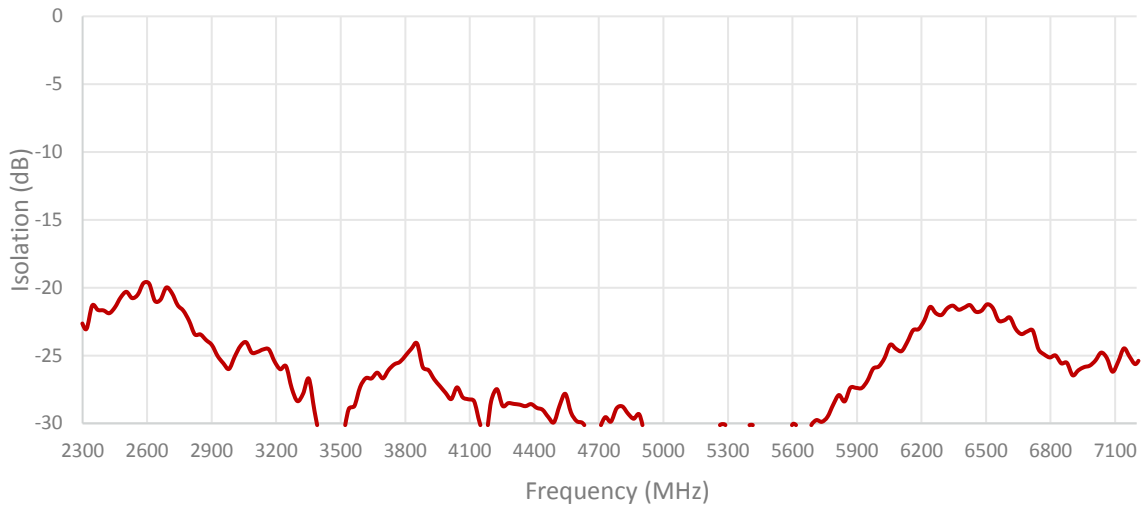

ISOLATION FOR CABLES 1 AND 4

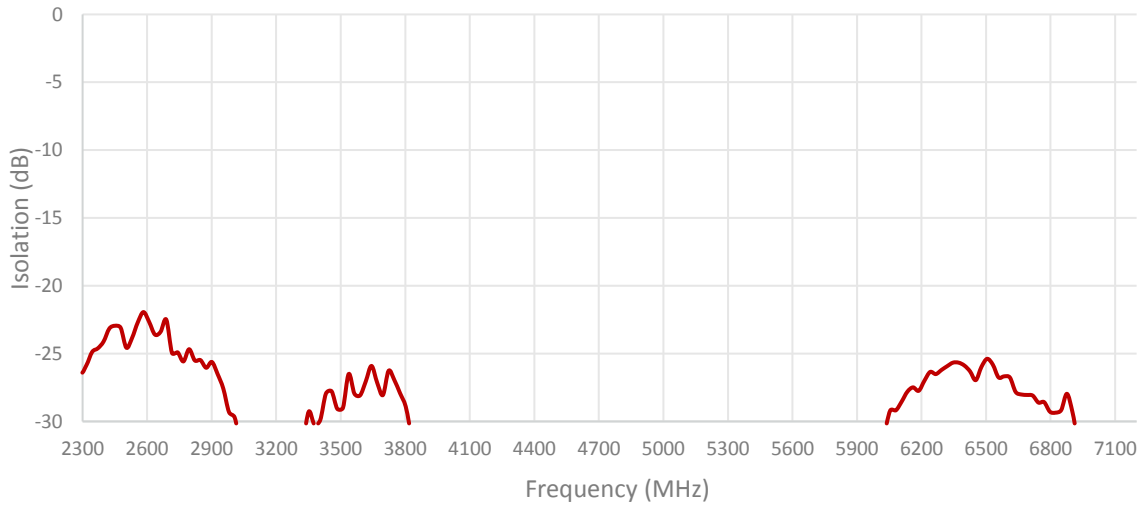

ISOLATION FOR CABLES 2 AND 3

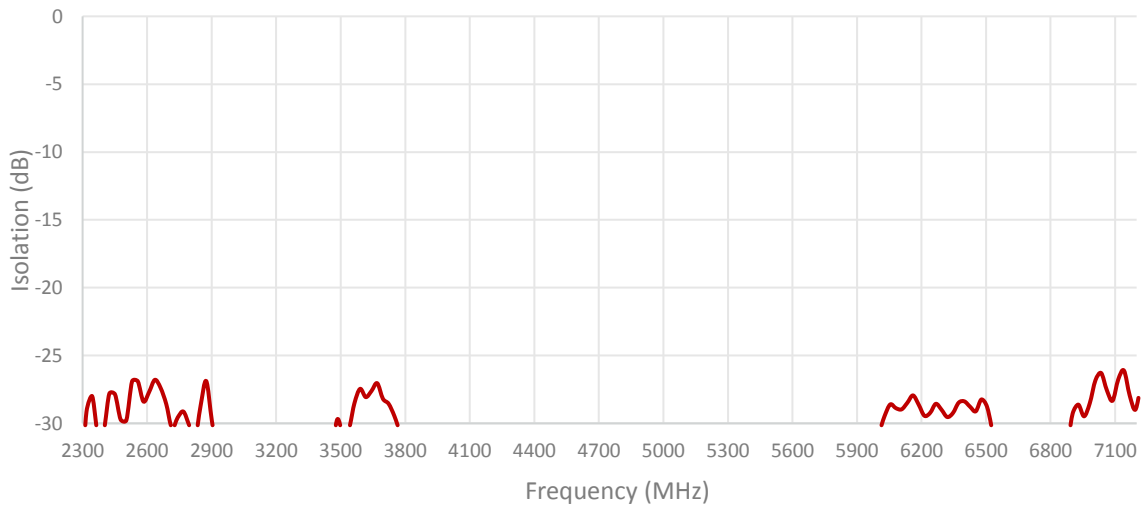

ISOLATION FOR CABLES 2 AND 4

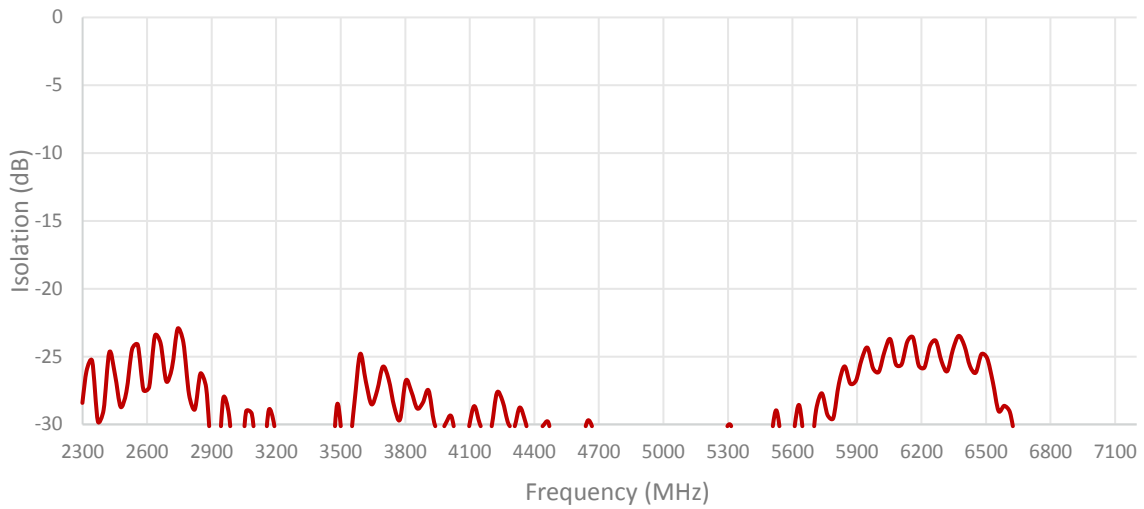

ISOLATION FOR CABLES 3 AND 4

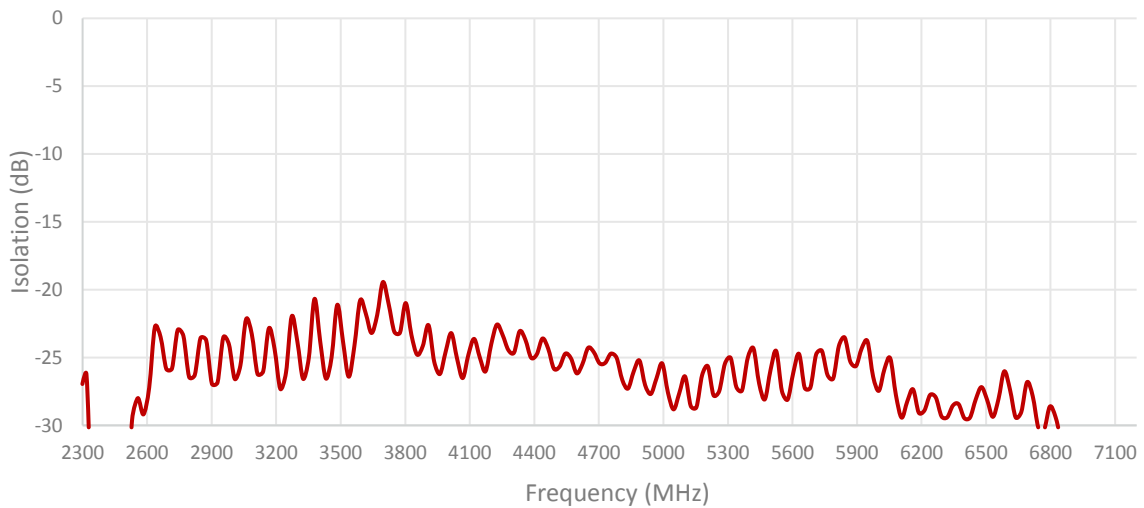

ENVELOPE CORRELATION COEFICIENT FOR CABLES 1 AND 2

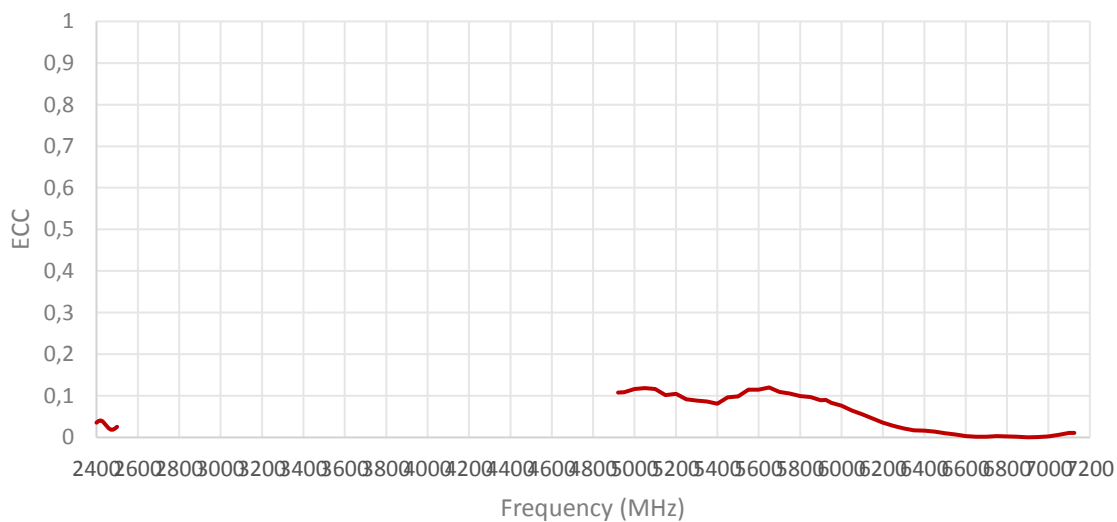

ENVELOPE CORRELATION COEFICIENT FOR CABLES 1 AND 3

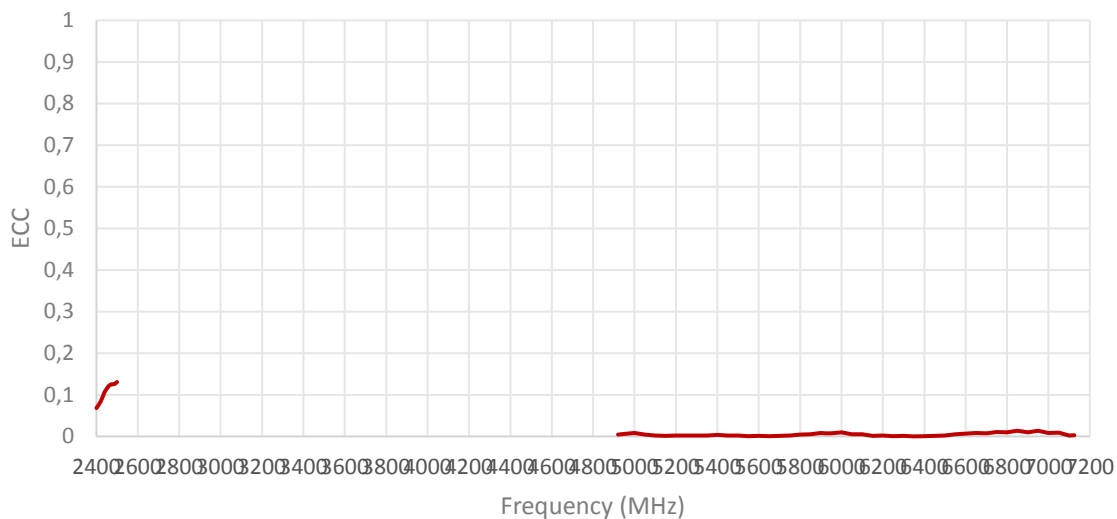

ENVELOPE CORRELATION COEFICIENT FOR CABLES 1 AND 4

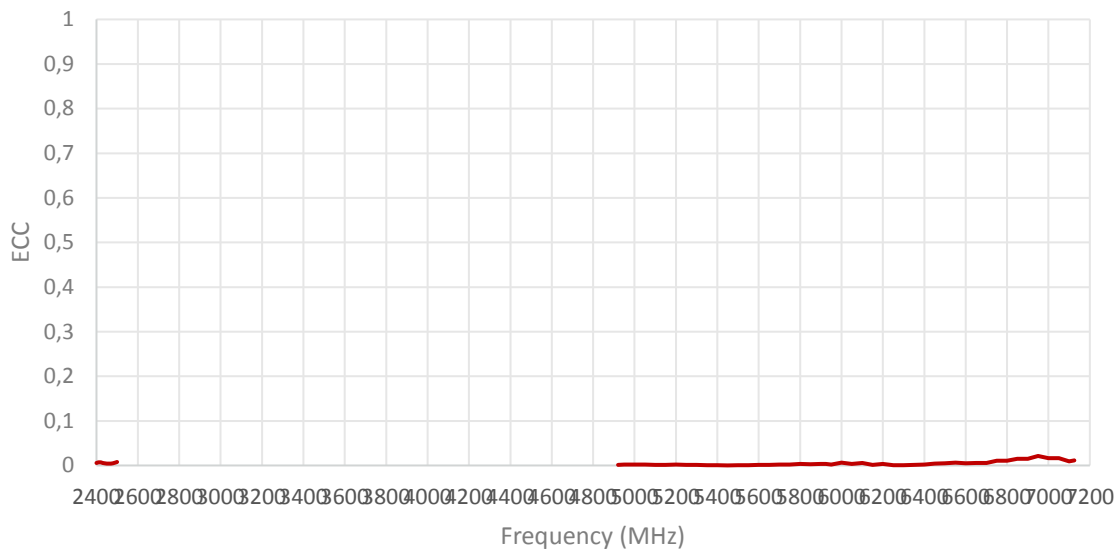

ENVELOPE CORRELATION COEFICIENT FOR CABLES 2 AND 3

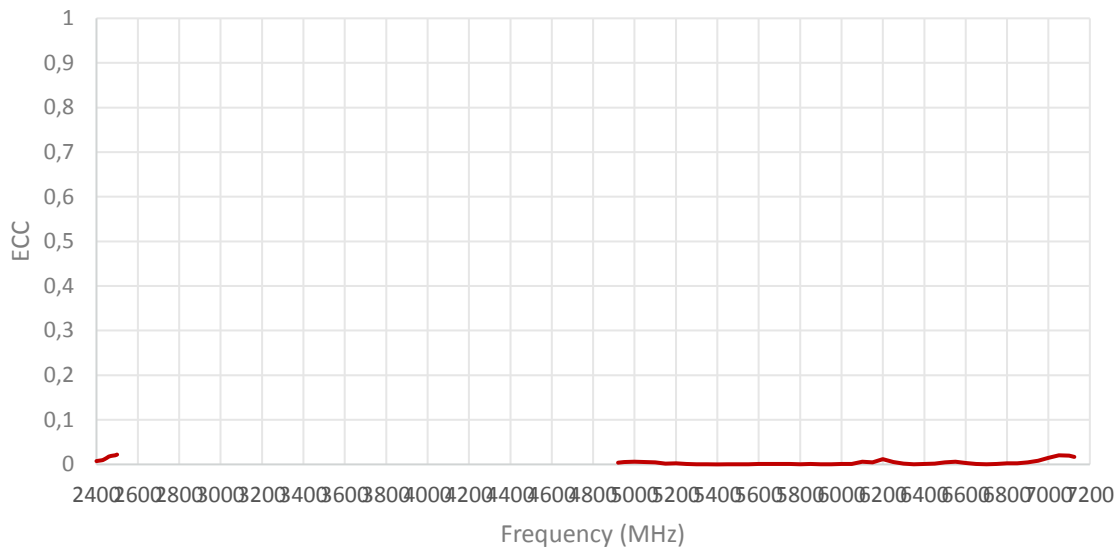

ENVELOPE CORRELATION COEFICIENT FOR CABLES 2 AND 4

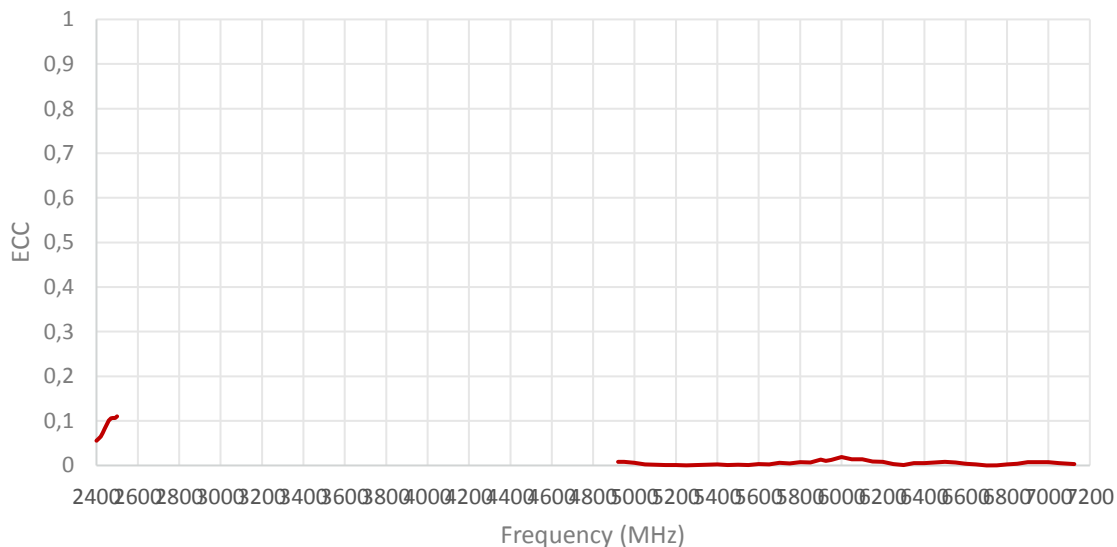

ENVELOPE CORRELATION COEFICIENT FOR CABLES 3 AND 4

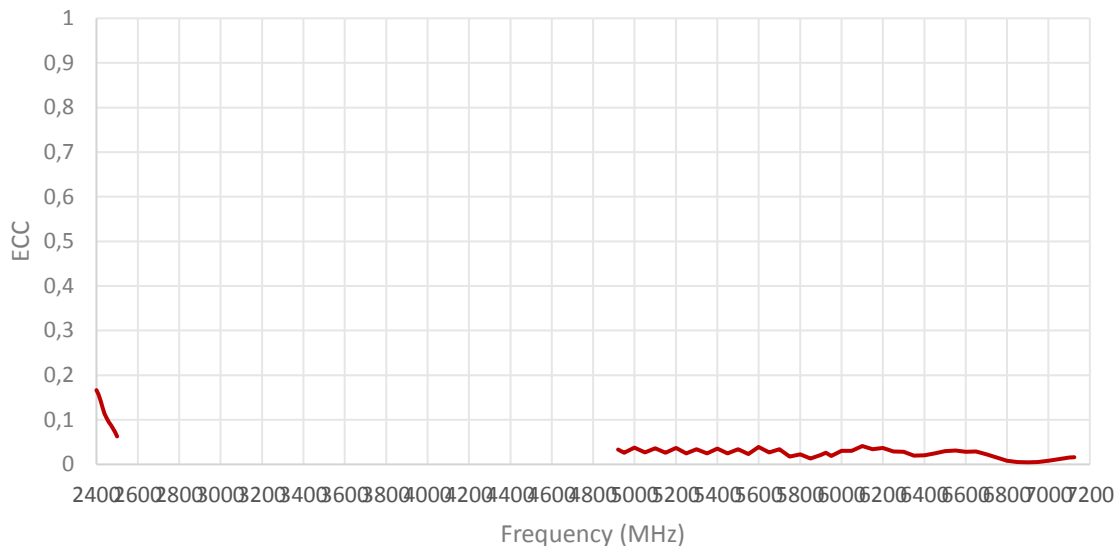

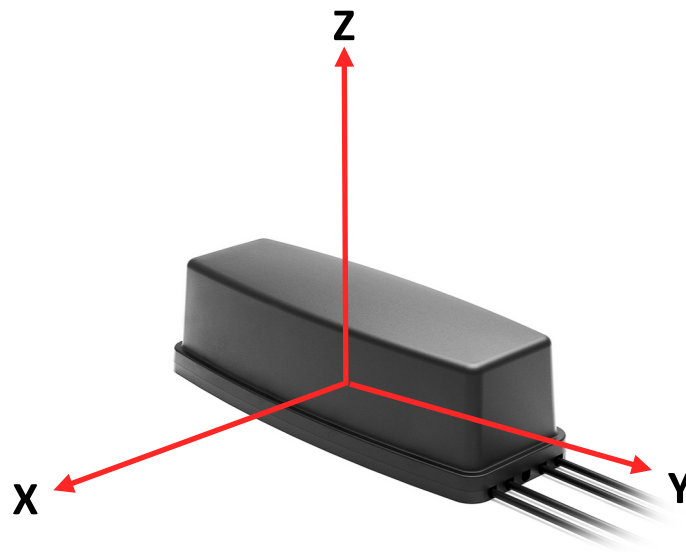

Radiation pattern reference

Cable 1: 2.4/5.0/6.0 GHz ISM

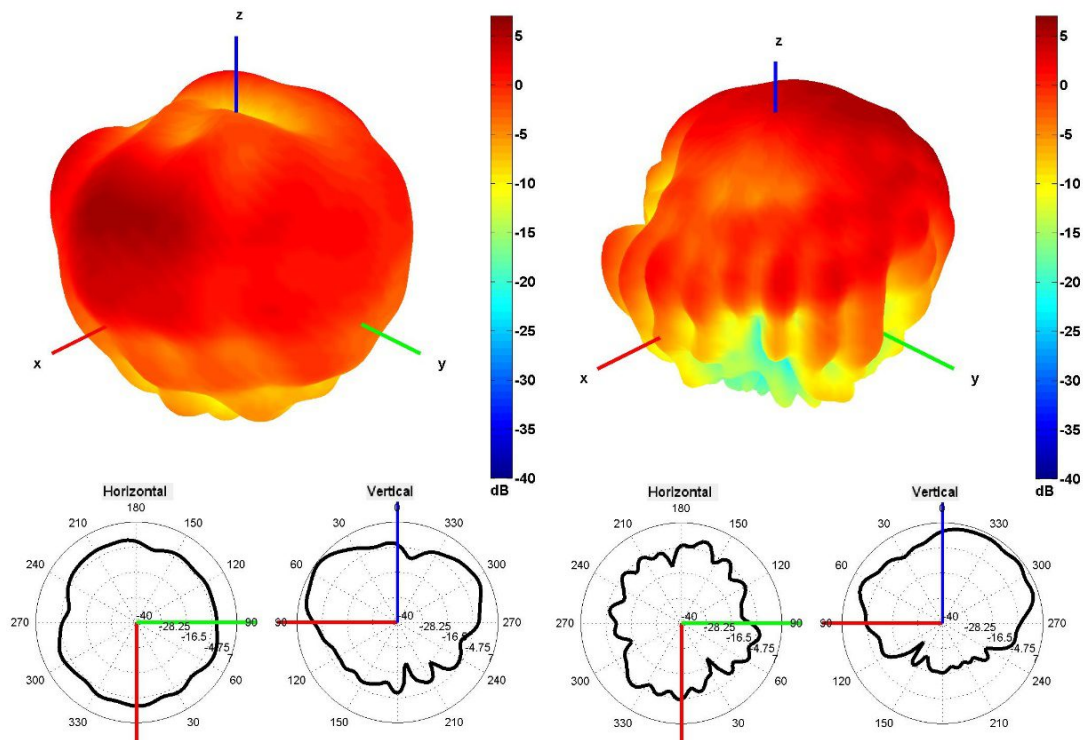

2450 and 5500 MHz Radiation pattern

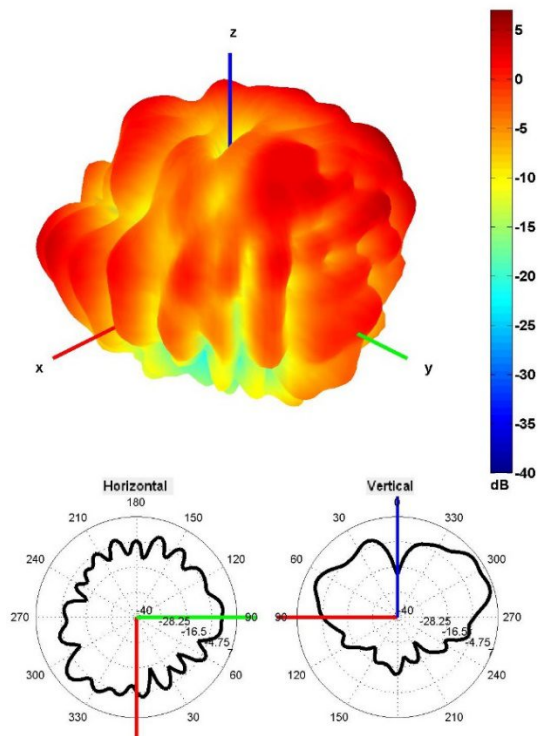

6500 MHz Radiation pattern

Cable 2: 2.4/5.0/6.0 GHz ISM

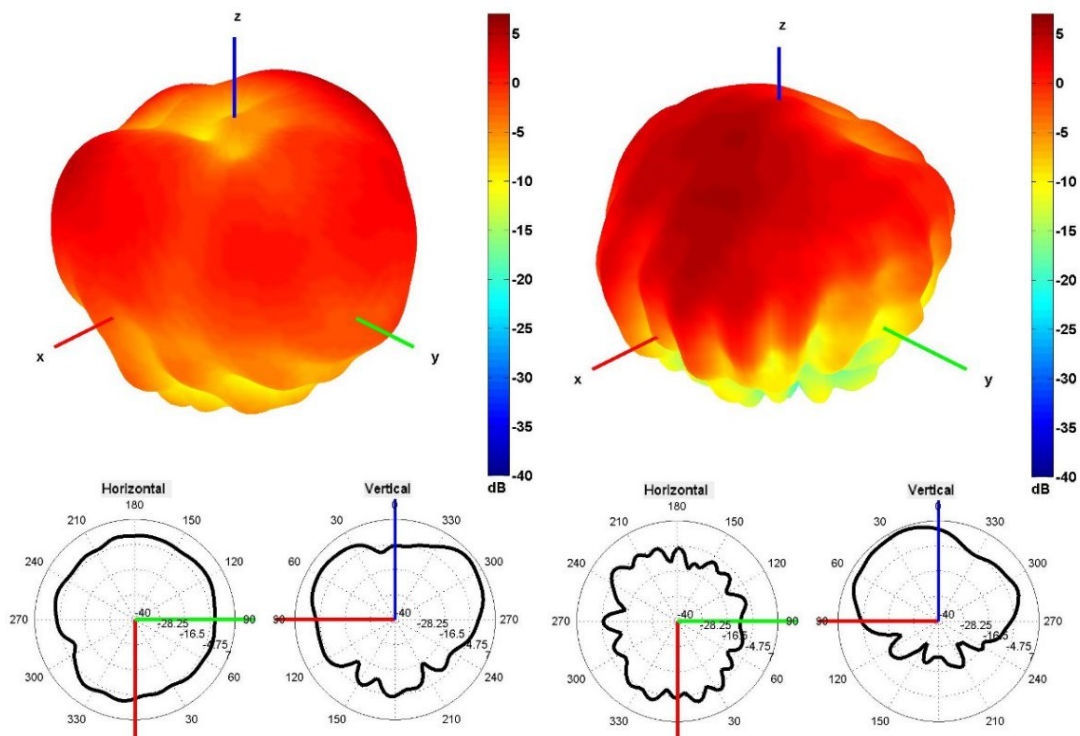

2450 and 5500 MHz Radiation pattern

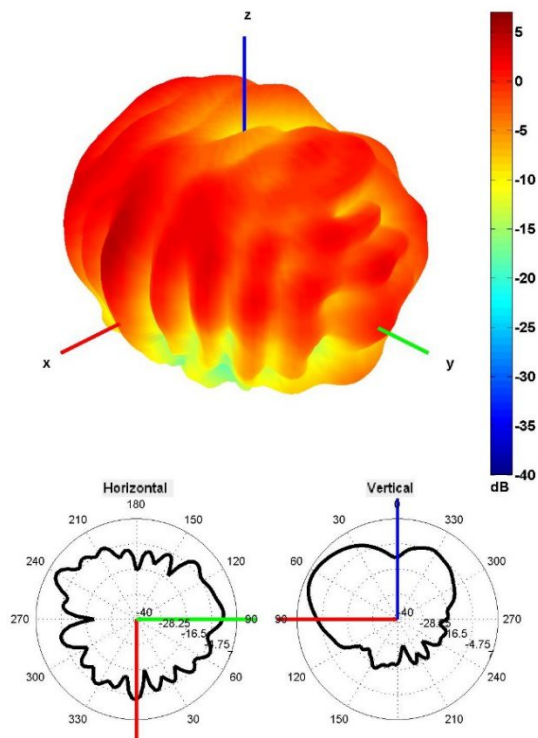

6500 MHz Radiation pattern

Cable 3: 2.4/5.0/6.0 GHz ISM

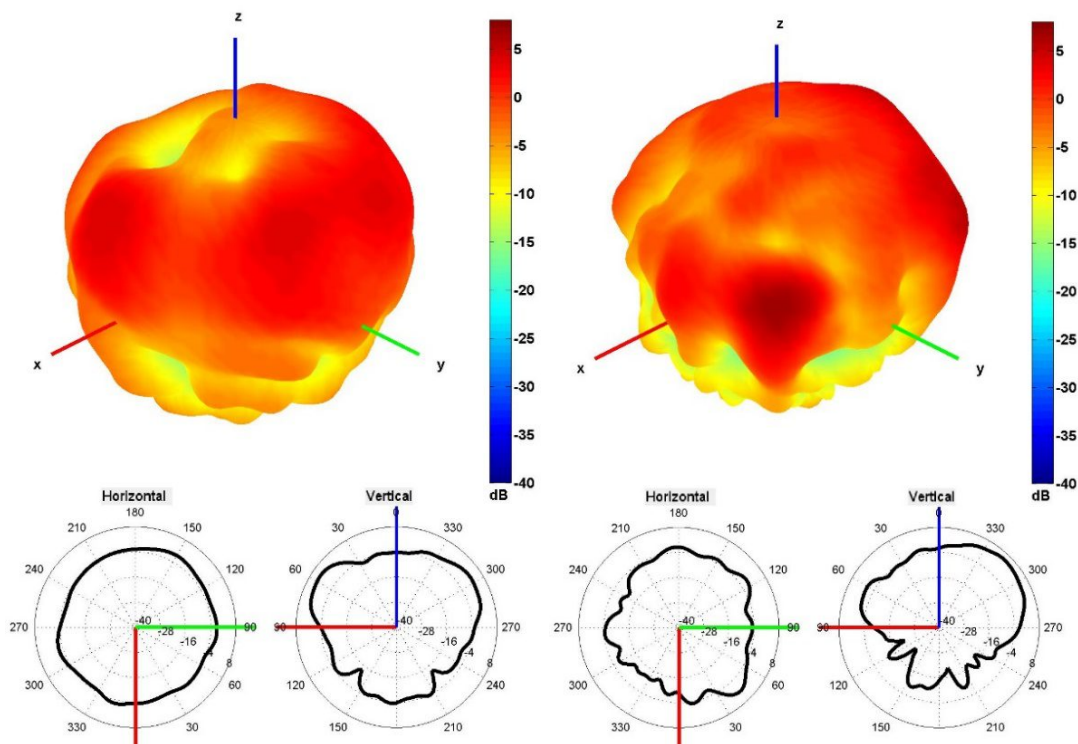

2450 and 5500 MHz Radiation pattern

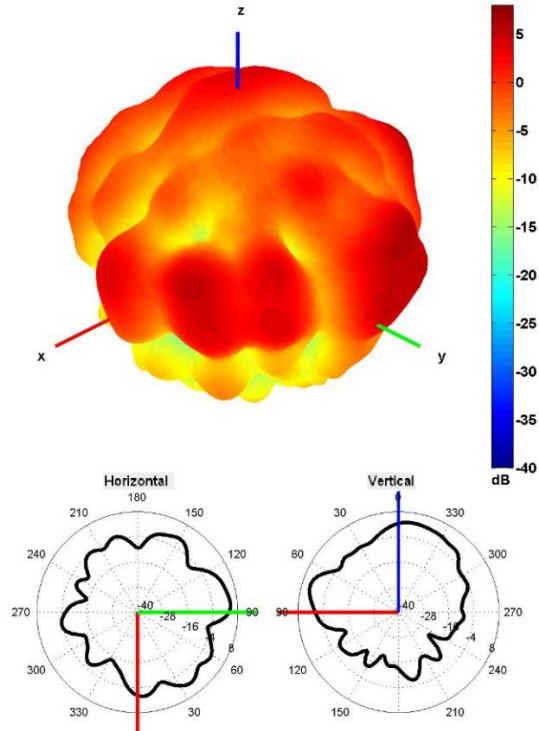

6500 MHz Radiation pattern

Cable 4: 2.4/5.0/6.0 GHz ISM

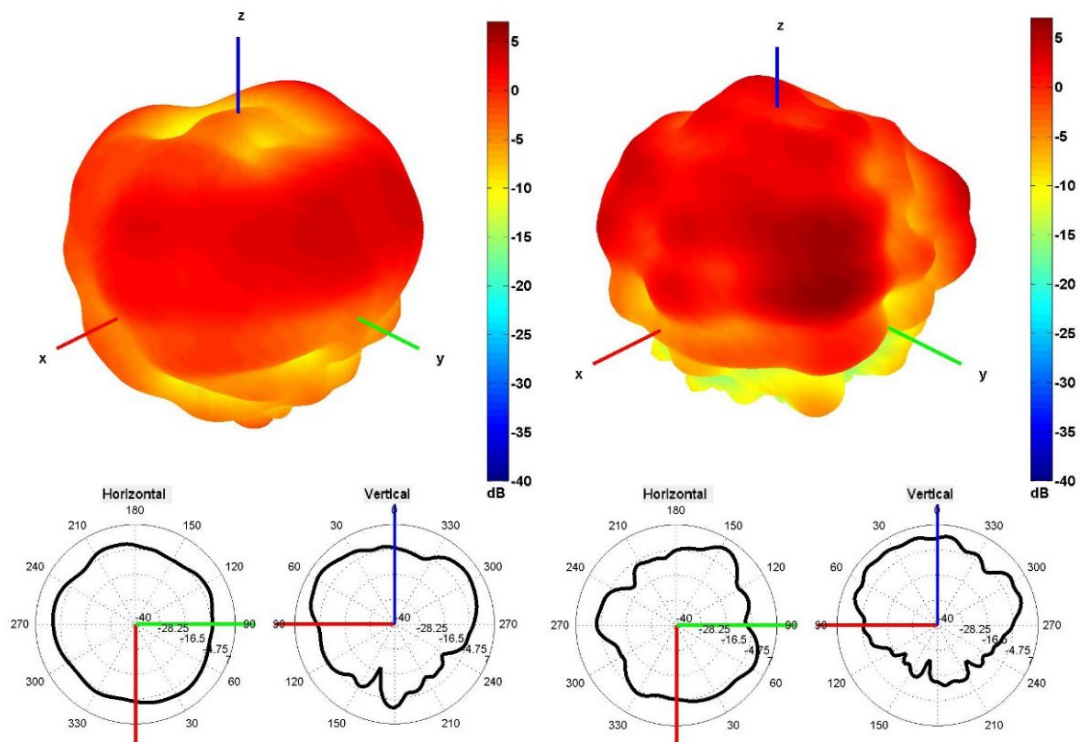

2450 and 5500 MHz Radiation pattern

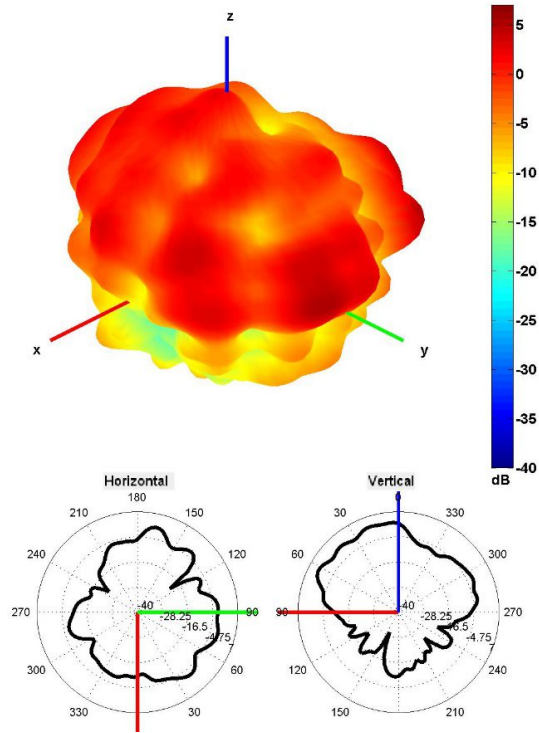

6500 MHz Radiation pattern

4. Antenna drawings

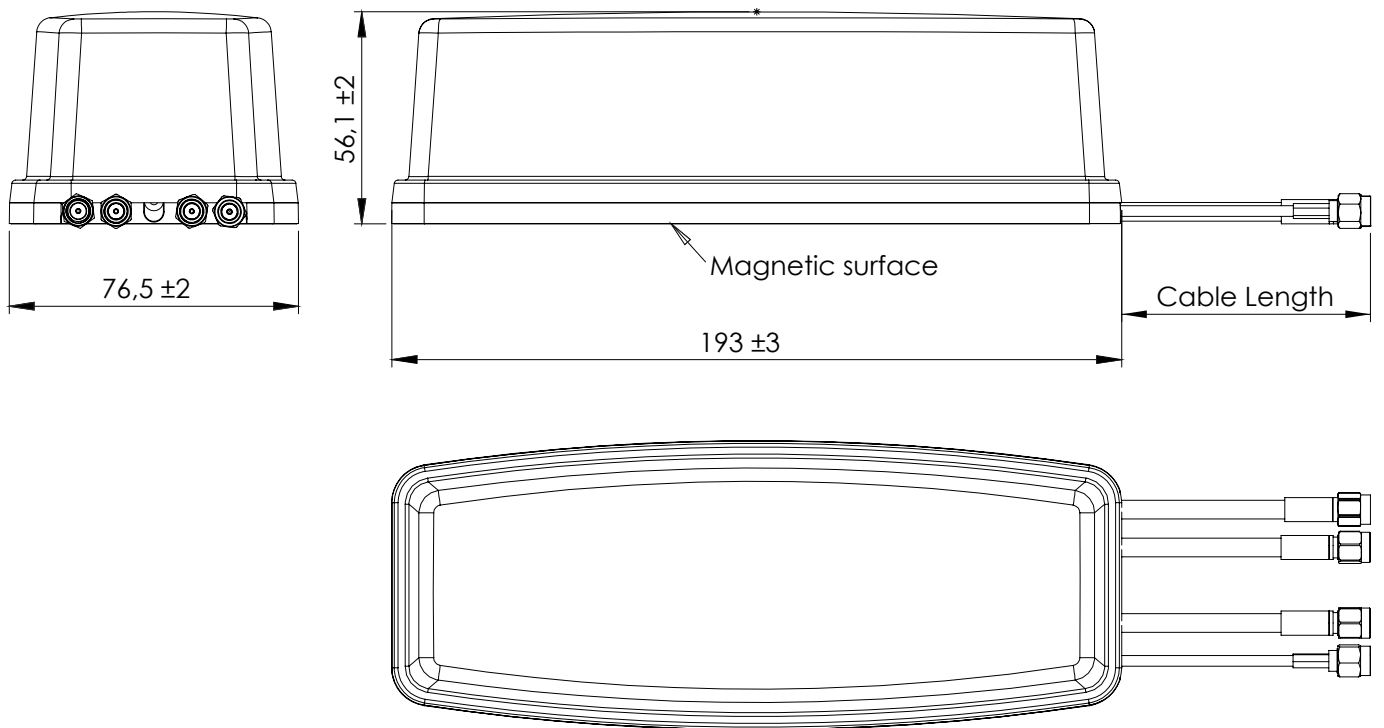

Note: Dimensions are in millimeters
***Dimensions are after mounting**

5. Antenna Images

