

2J6A84BGFa-RB-SP

5GNR MIMO and GNSS Screw Mount

Key Features

Cable 1 and 2: 5GNR

- 617-960 MHz
- 1427-2690 MHz
- 3300-5000 MHz
- 5150-5925 MHz

Cable 3: GPS/GLONASS/QZSS/Galileo

- 1575-1606 MHz

Screw Mount

Anti-Rotation

Pre-Filtered GNSS

Ground Plane Dependent

Customizable Cable and Connector

Dimensions Ø 69 × 65.5 mm

Certificates: IP67, IK09, IP69K



1. Antenna and electrical specifications

Cable 1

Parameters	5GNR Antenna			
Technologies	5G, 4G, 3G and 2G			
Standards	5GNR/4GLTE/FirstNet/CBRS/LPWA/CAT-X/CAT-Mx/CAT-NBx/NB-IoT/3G/2G			
Frequency (MHz)	617-960	1427-2690	3300-5000	5150-5925
Band (MHz)	600, 700, 850, 900	1500, 1600, 1700, 1800, 1900, 2000, 2100, 2300, 2500, 2600	3300, 3500, 3600, 3700, 4500	5200, 5500, 5800
5GNR Bands	n5, n8, 12, n20, n28, n71, n81, n82, n83,	n1, n2, n3, n7, n25, n34, n38, n39, n40, n41, n50, n51, n66, n70, n74, n75, n76, n80, n84, n86	n77, n78, n79	
4GLTE Bands	B5, B6, B8, B12, B13, B14, B17, B18, B19, B20, B26, B27, B28, B29, B44, B67, B68, B71, B85	B1, B2, B3, B4, B7, B9, B10, B11, B21, B23, B24, B25, B30, B32, B33, B34, B35, B36, B37, B38, B39, B40, B41, B45, B50, B51, B65, B66, B69, B70, B74, B75, B76	B22, B42, B43, B48, B49, B52	B46, B47, B252, B255
3GCELL Bands	B5, B6, B8, B12, B13, B14, B19, B20, B26	B1, B2, B3, B4, B7, B9, B10, B11, B21, B25, B32, B33, B34, B35, B36, B37, B38, B39, B40	B22	
2GCELL Bands	710, 750, 810T, 850, 900P, 900E, 900R	1800DCS, 1900PCS		
CDMACELL Bands	BC0, BC2, BC3, BC7, BC9, BC10, BC12, BC18, BC19	BC1, BC4, BC6, BC8, BC13, BC14, BC15, BC16, BC20, BC21		
Return Loss (dB)	~-5.1	~-15.2	~-13.5	~-7.5
VSWR	~4.8:1	~1.7:1	~1.7:1	~2.6:1
Efficiency (%)	~30.7	~45.1	~35.9	~22.8
Peak Gain (dBi)	~-1.9	~-2.4	~-3.4	~-0.7
Average Gain (dB)	~-5.4	~-3.8	~-4.4	~-6.6
Impedance (Ohm)	50			
Polarisation	Linear			
Radiation Pattern	Omni-Directional			
Max. Input Power (W)	35			
Connector Type	SMA-Male Standard (Other Connectors Available)			
Cable Length	300 cm Standard (Any Cable Length Available)			
Cable Type	D302 Standard (Other Cables Available)			

Cable 2

Parameters	5G NR Antenna			
Technologies	5G, 4G, 3G and 2G			
Standards	5G NR/4G LTE/FirstNet/CBRS/LPWA/CAT-X/CAT-Mx/CAT-NBx/NB-IoT/3G/2G			
Frequency (MHz)	617-960	1427-2690	3300-5000	5150-5925
Band (MHz)	600, 700, 850, 900	1500, 1600, 1700, 1800, 1900, 2000, 2100, 2300, 2500, 2600	3300, 3500, 3600, 3700, 4500	5200, 5500, 5800
5G NR Bands	n5, n8, 12, n20, n28, n71, n81, n82, n83,	n1, n2, n3, n7, n25, n34, n38, n39, n40, n41, n50, n51, n66, n70, n74, n75, n76, n80, n84, n86	n77, n78, n79	
4G LTE Bands	B5, B6, B8, B12, B13, B14, B17, B18, B19, B20, B26, B27, B28, B29, B44, B67, B68, B71, B85	B1, B2, B3, B4, B7, B9, B10, B11, B21, B23, B24, B25, B30, B32, B33, B34, B35, B36, B37, B38, B39, B40, B41, B45, B50, B51, B65, B66, B69, B70, B74, B75, B76	B22, B42, B43, B48, B49, B52	B46, B47, B252, B255
3G CELL Bands	B5, B6, B8, B12, B13, B14, B19, B20, B26	B1, B2, B3, B4, B7, B9, B10, B11, B21, B25, B32, B33, B34, B35, B36, B37, B38, B39, B40	B22	
2G CELL Bands	710, 750, 810T, 850, 900P, 900E, 900R	1800DCS, 1900PCS		
CDMA CELL Bands	BC0, BC2, BC3, BC7, BC9, BC10, BC12, BC18, BC19	BC1, BC4, BC6, BC8, BC13, BC14, BC15, BC16, BC20, BC21		
Return Loss (dB)	~-5.2	~-12.0	~-10.3	~-5.0
VSWR	~4.8:1	~1.9:1	~2.1:1	~3.7:1
Efficiency (%)	~30.2	~46.1	~33.9	~20.4
Peak Gain (dBi)	~-1.8	~2.4	~2.6	~-2.1
Average Gain (dB)	~-5.6	~-3.5	~-4.9	~-7.4
Impedance (Ohm)	50			
Polarisation	Linear			
Radiation Pattern	Omni-Directional			
Max. Input Power (W)	35			
Connector Type	SMA-Male Standard (Other Connectors Available)			
Cable Length	300 cm Standard (Any Cable Length Available)			
Cable Type	D302 Standard (Other Cables Available)			

Antenna Measurement Conditions:

Mounted on 30 x 30 cm Metal Plate

D302 100 cm Cable Length

Measured in Certified CTIA 3D Anechoic Chamber

Cable 3

Parameters	GPS/GLONASS Antenna	
	GPS/QZSS/Galileo	GLONASS
Standard		
Band (MHz)	1575	1602
Frequency(MHz)	1575.42	1598-1606
Patch Size (mm)	25 x 25 x 4	
Return Loss (dB)	<=-15.0 dB	
VSWR	<=1.4:1 dB	
Impedance	50	
Radiation Pattern	Hemispherical	
Polarization	RHCP	
Saw Filter	Pre-filter	
Active Gain (dB)	28 @ 2.7 V	
Noise Figure (dB)	1.5 Typ	
Voltage (V)	1.5 – 3.6	
Current (mA)	9 Typ	
Power Consumption (mW)	24.3 Typ	
ESD Protection (kV)	2kV	
Connector Type	SMA-Male Standard (Other Connectors Available)	
Cable Length	300 cm Standard (Any Cable Length Available)	
Cable Type	LL100 Standard (Other Cables Available)	

2. Mechanical and environmental specifications

Specifications	2J6A84BGFa-RB-SP
Mounting Type	Screw Mount
Dimensions (mm)	Ø 69 x 65.5
Rec. Tighten Torque (Nm)	6 Nm
Radome	ASA
Radome color	Black
Antenna Base	Zamak
Operating Temperature (C)	-40 to +85
Storage Temperature (C)	-40 to +85
Substance Compliance	RoHS
Certificates	IP67, IK09, IP69K

3. Antenna parameters

Cable 1: 5GNR

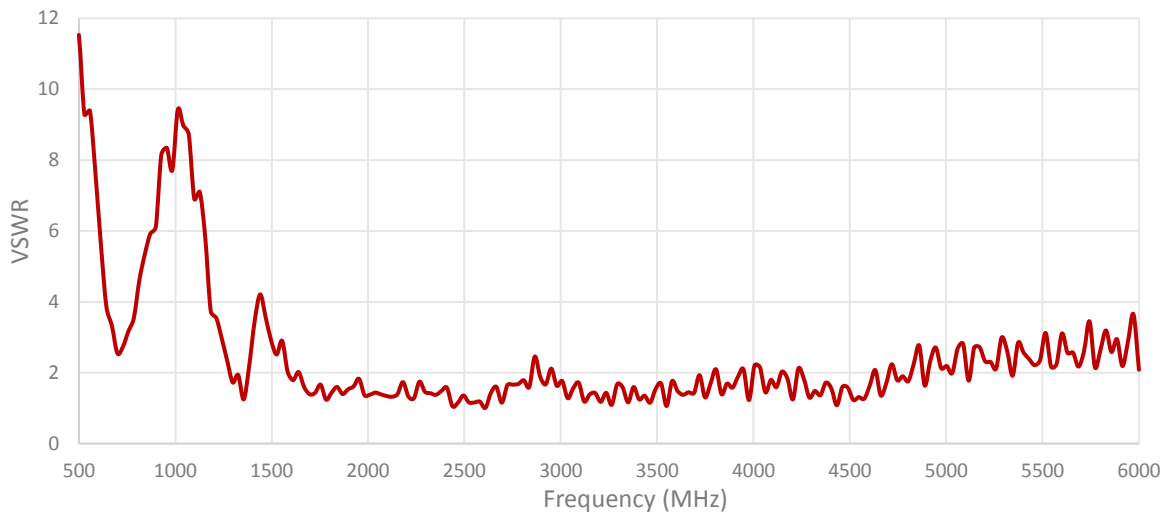
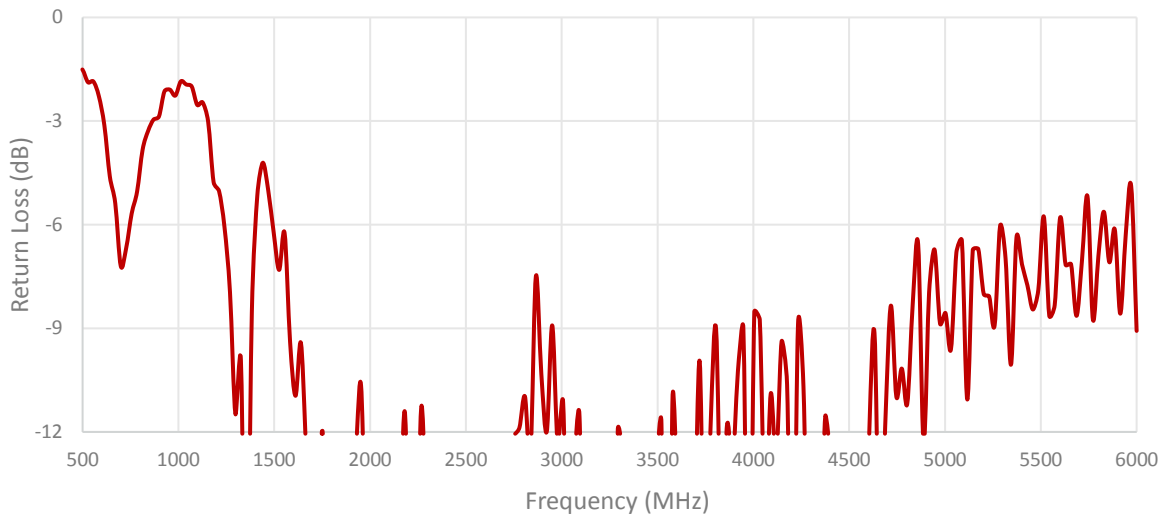

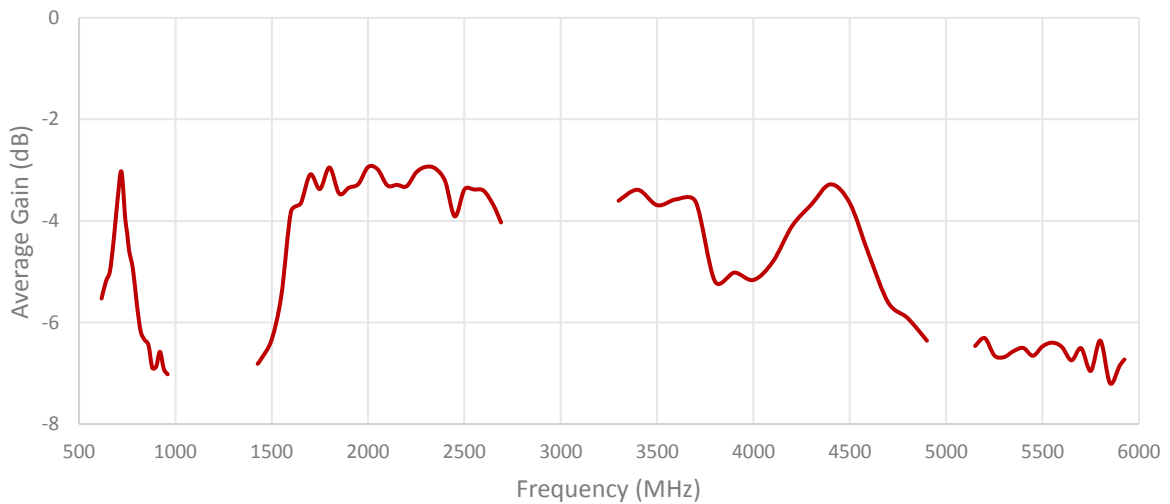
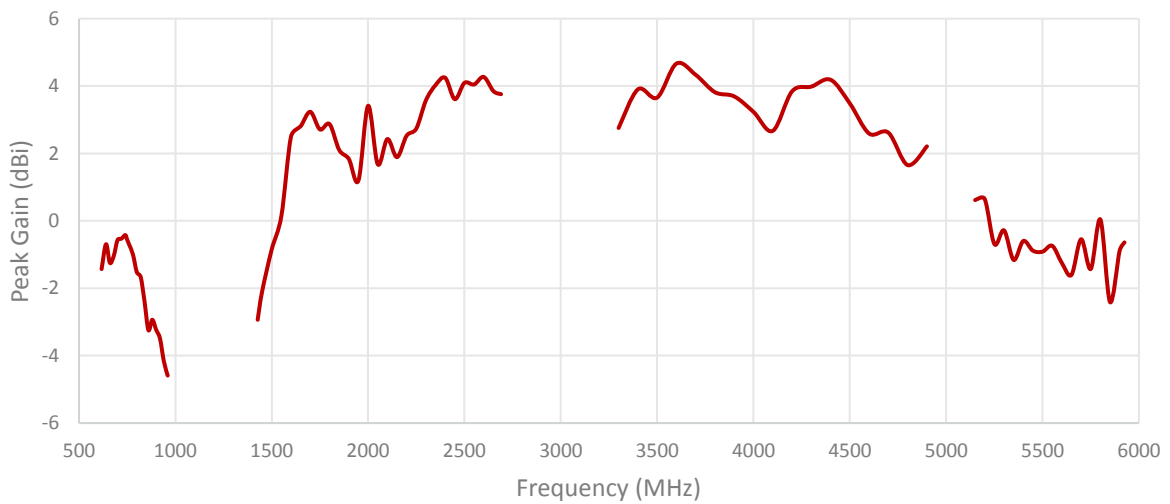
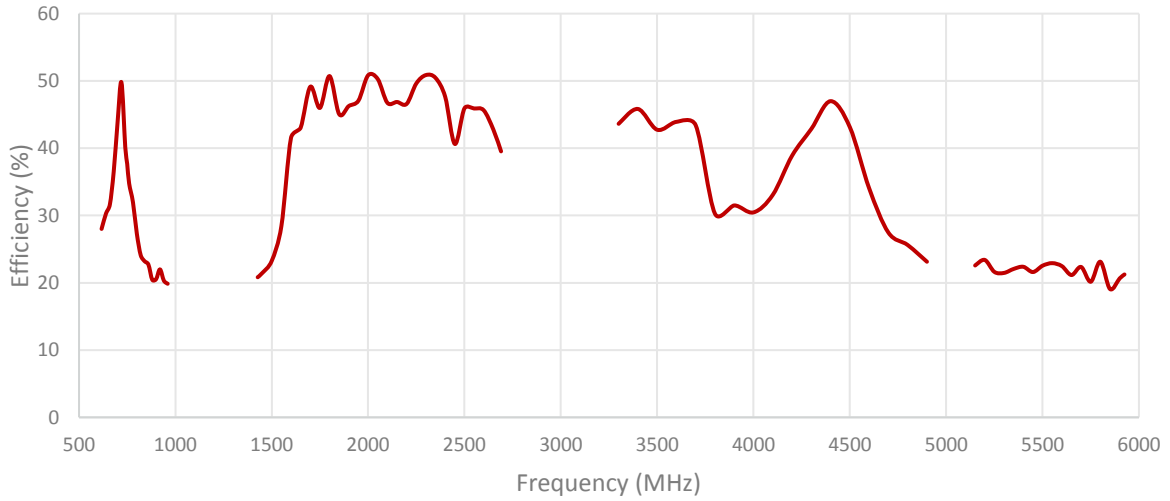

Cable 2: 5GNR

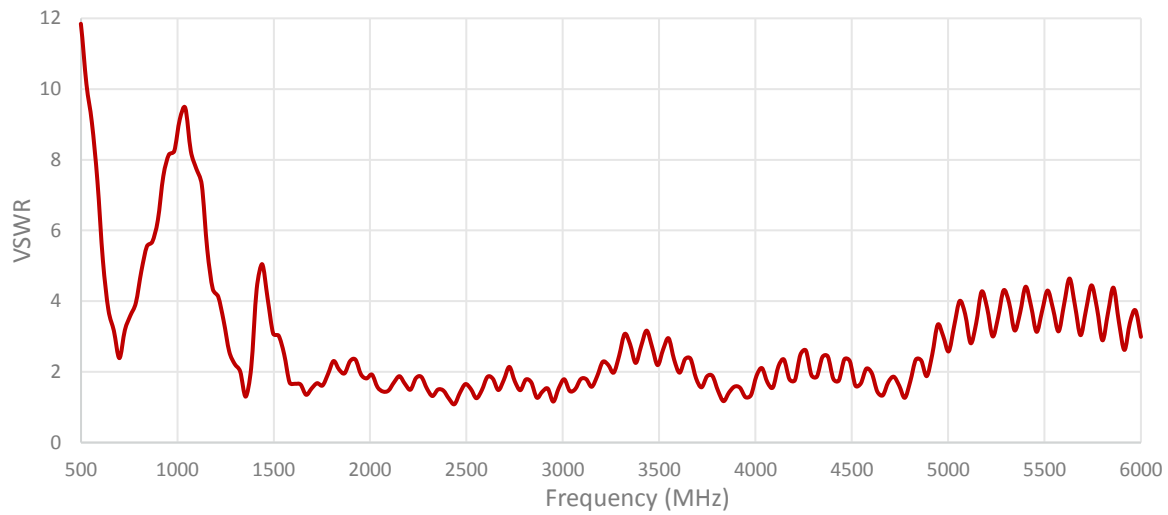
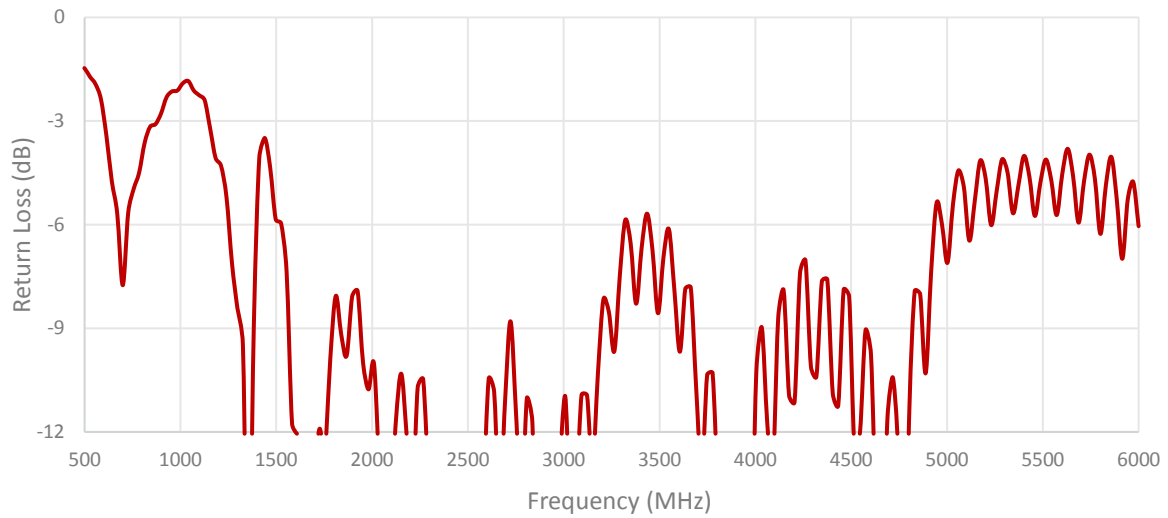

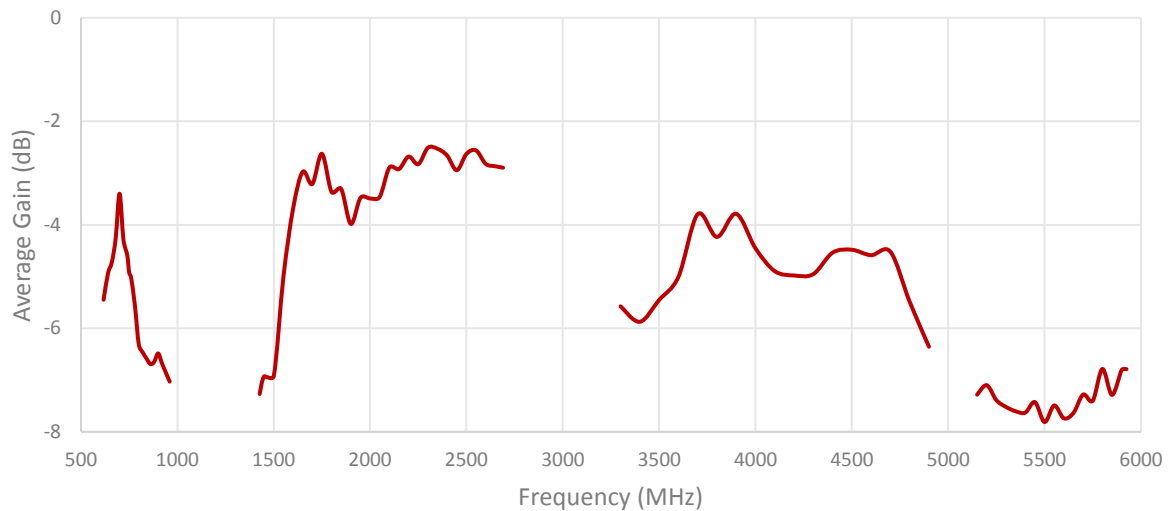
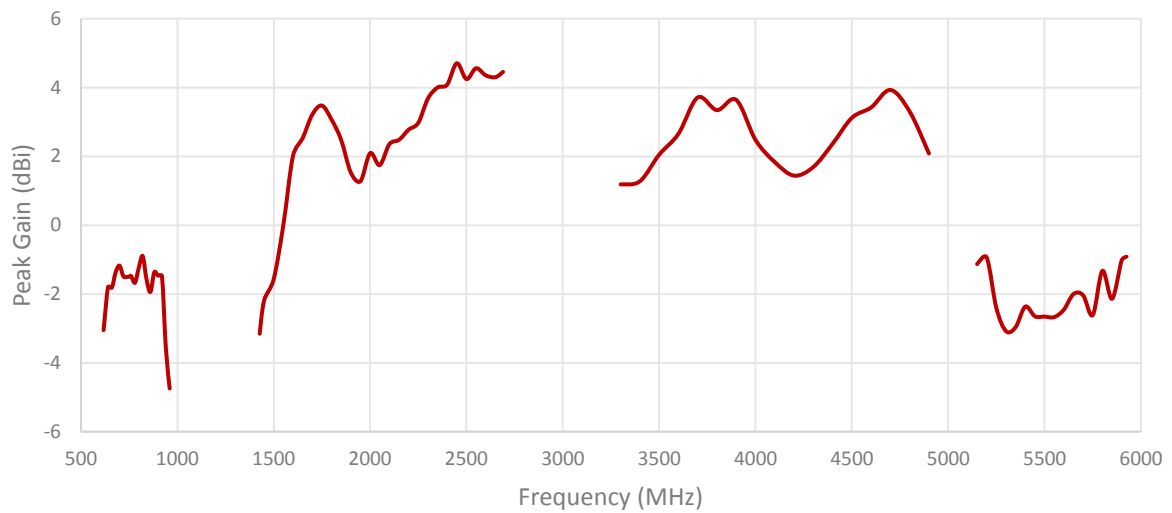
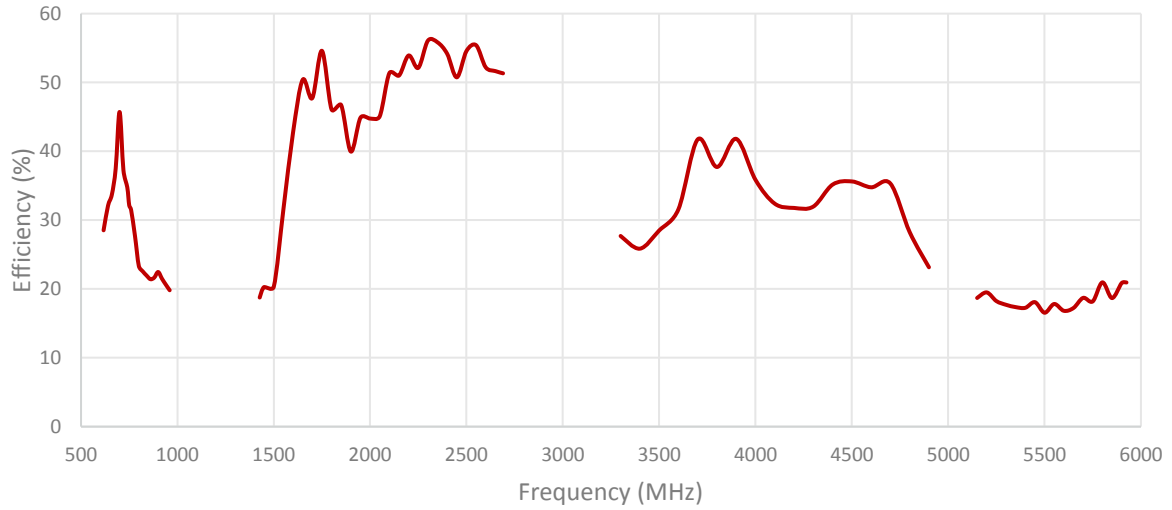

ISOLATION FOR CABLES 1 AND 2

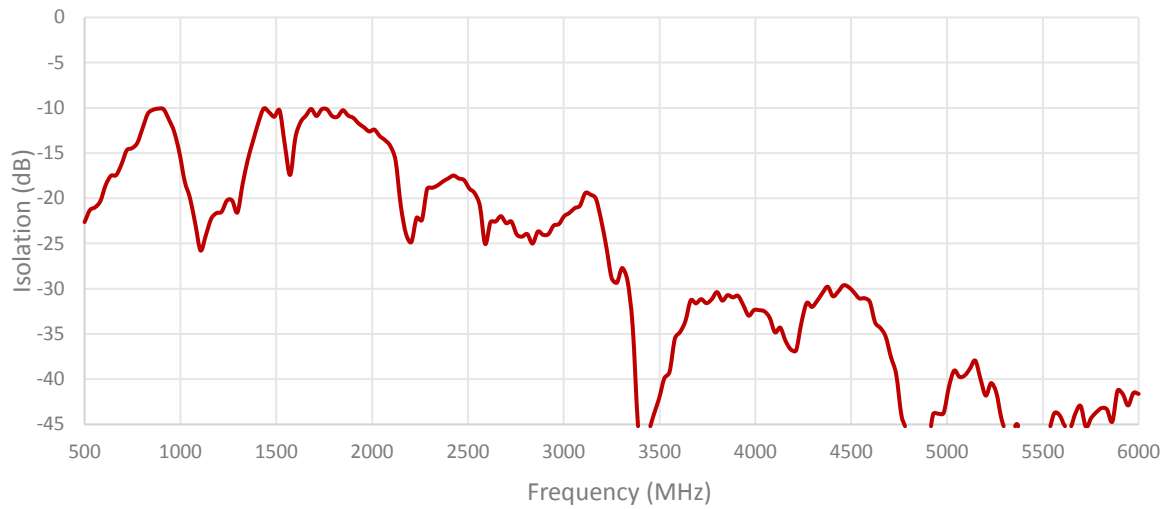

ENVELOPE CORRELATION COEFFICIENT FOR CABLES 1 AND 2

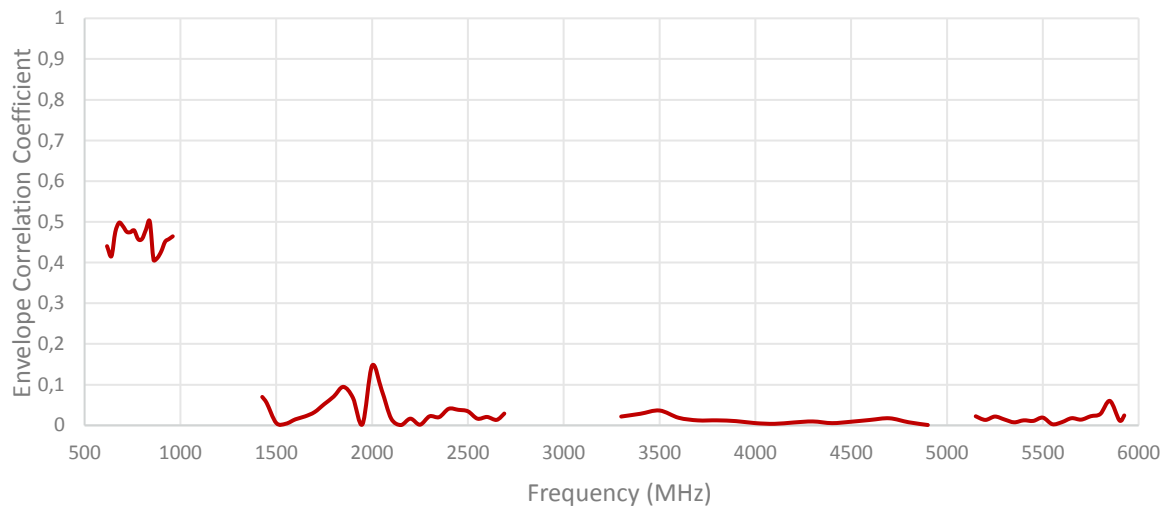

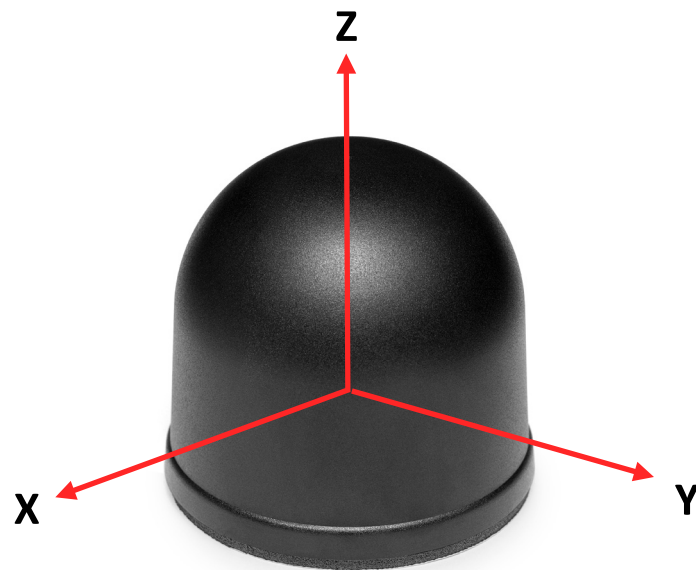

Radiation pattern reference

Cable 1: 5GNR

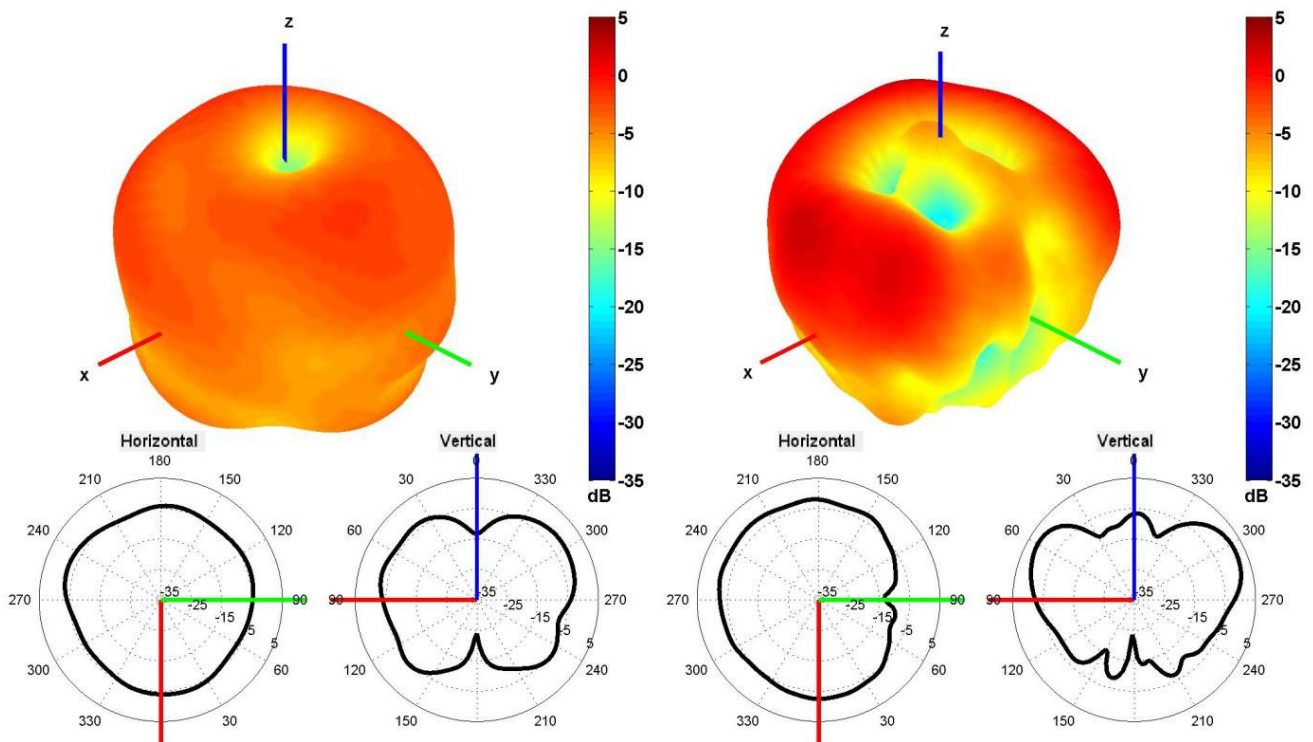

750 and 2500 MHz Radiation pattern

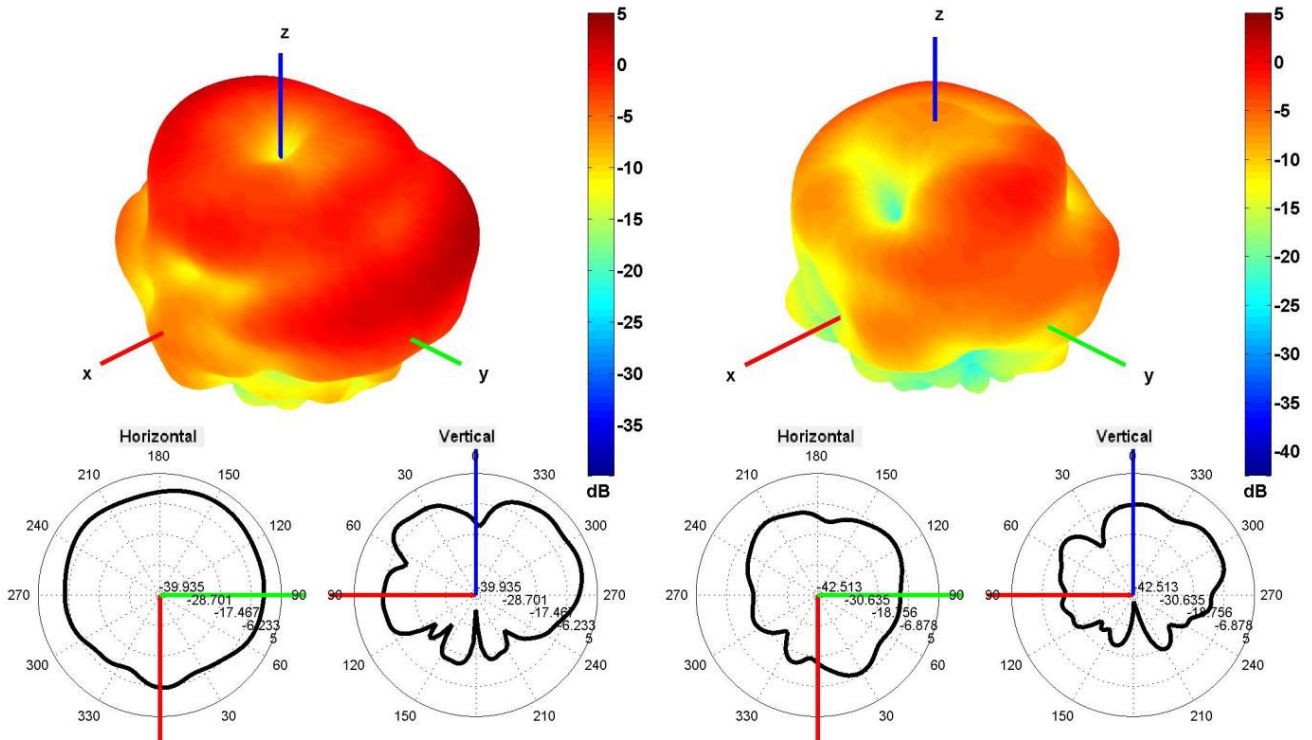

4500 and 5500 MHz Radiation pattern

Table 2: 5GNR

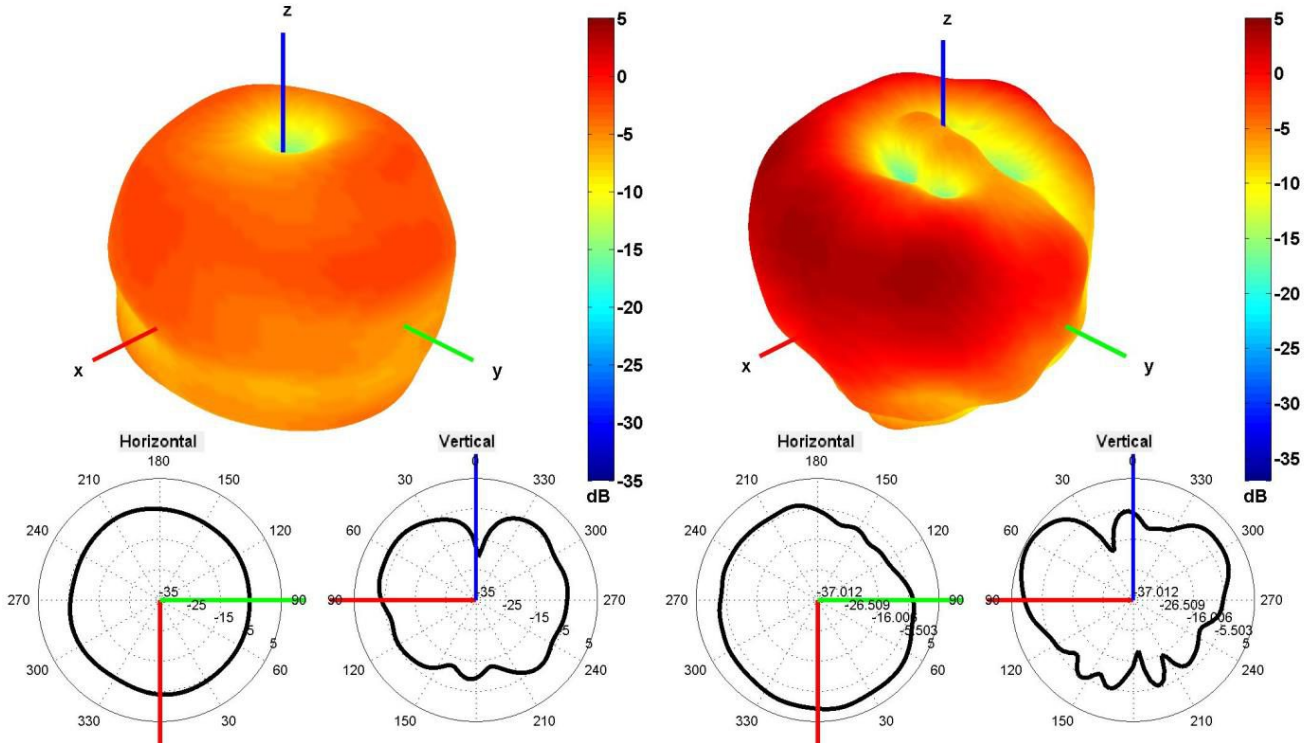

750 and 2500 MHz Radiation pattern

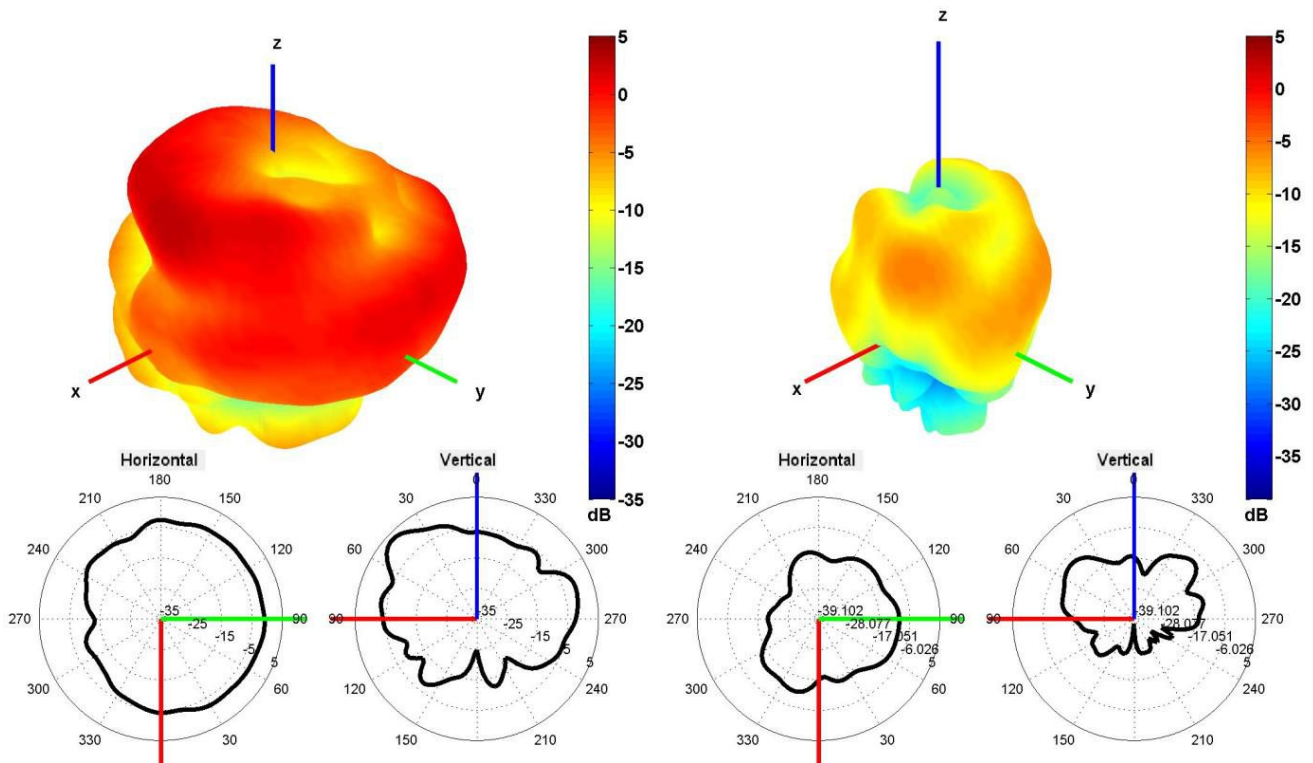

4500 and 5500 MHz Radiation pattern

4. Antenna drawings

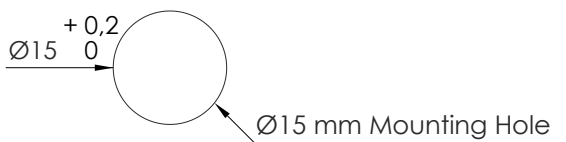
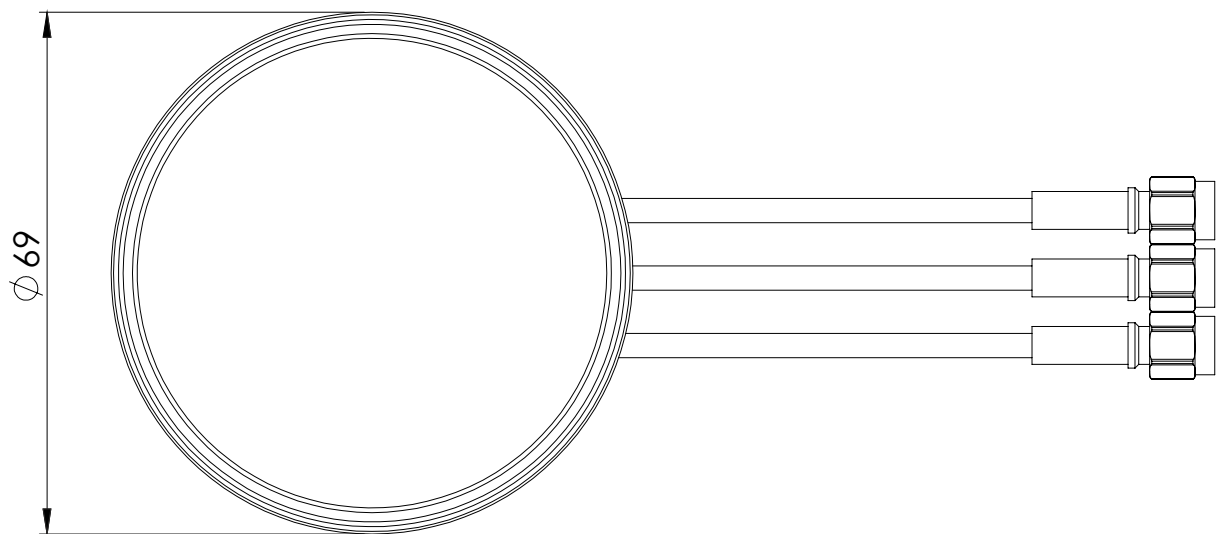
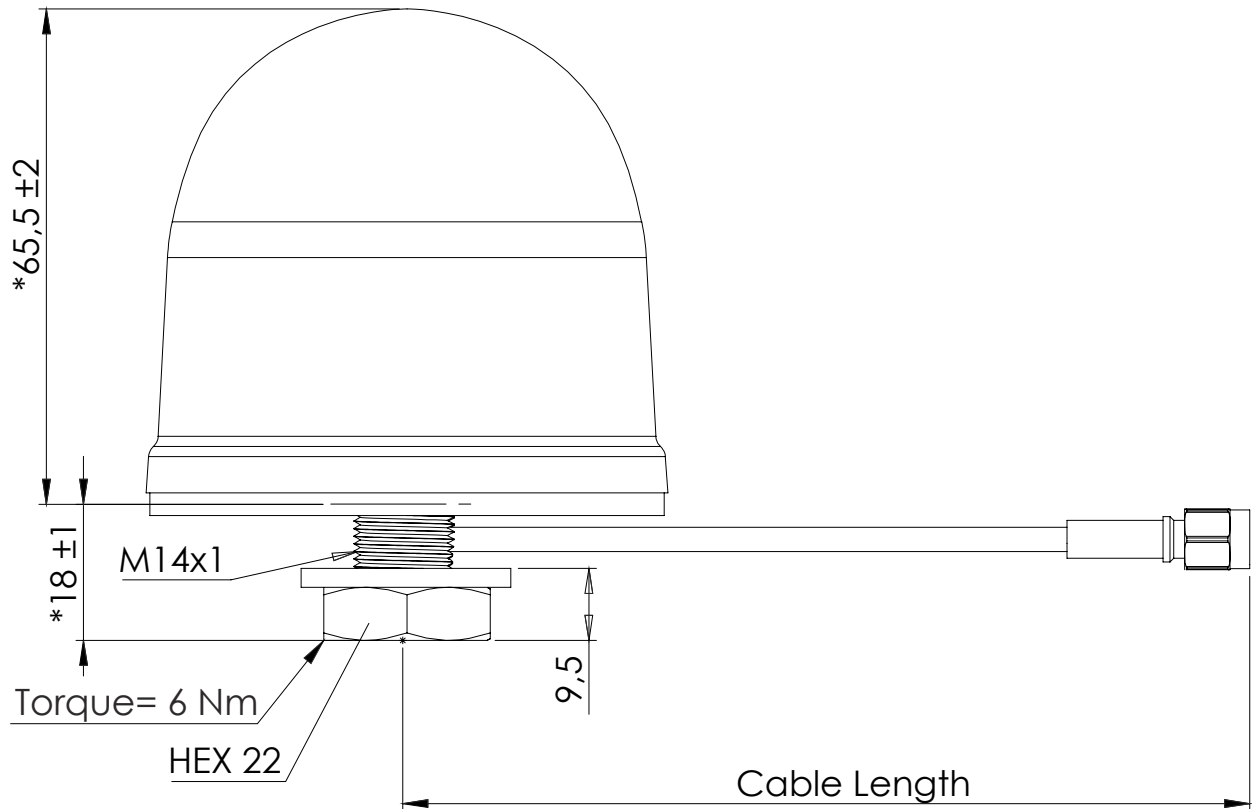

Note: Dimensions are in millimeters
*Dimensions are after mounting
**Mounting Torque= 6 Nm

5. Antenna Images

