

2J6A50BCF

CELLULAR/LTE, 2.4/5.0 GHz ISM and GNSS Screw Mount

Key Features

Cable 1: CELLULAR / LTE

- 698-960 MHz
- 1710-2170 MHz
- 2500-2700 MHz

Cable 2: 2.4/5.0 GHz ISM

- 2410-2490 MHz
- 4920-5925 MHz

Cable 3: GPS/GLONASS/BeiDou/QZSS/GNSS

- 1561-1606 MHz

Screw Mount

Anti-Rotation Mechanism

Ground Plane Dependent

Customizable Cable and Connector

Dimensions: Ø 77.3 x 65.5 mm

Certificates: IP67, IK09, IP69K



1. Antenna and electrical specifications

Cable 1

Parameters	CELLULAR / LTE Antenna		
Standards	2G,3G and 4G		
Band (MHz)	700/850/900	1700/1800/1900/2100	2600
Frequency (MHz)	698-960	1710-2170	2500-2700
Return Loss (dB)	~-10.3	~-14.8	~-15.1
VSWR	~2.1:1	~1.5:1	~1.5:1
Efficiency (%)	~52	~62	~50
Peak Gain (dBi)	~-0.7	~3.4	~4.0
Average Gain (dB)	~-2.9	~-2.1	~-3.0
Impedance (Ohm)	50		
Polarisation	Linear		
Radiation Pattern	Omni-Directional		
Max. Input Power (W)	25		
Connector Type	SMA-Male Standard (Other Connectors Available)		
Cable Length	300 cm Standard (Any Cable Length Available)		
Cable Type	DACAR302 Standard (Other Cables Available)		

Cable 2

Parameters	2.4/5.0 GHz ISM Antenna	
Standards	WiFi, BT, ZigBee, ISM	
Band (MHz)	2.4 GHz	5.0 GHz
Frequency (MHz)	2410-2490	4920-5925
Return Loss (dB)	~-20.2	~-11.1
VSWR	~1.2:1	~1.8:1
Efficiency (%)	~60.5	~38.4
Peak Gain (dBi)	~-5.0	~-3.9
Average Gain (dB)	~-2.2	~-4.2
Impedance (Ohm)	50	
Polarisation	Linear	
Radiation Pattern	Omni-Directional	
Max. Input Power (W)	25	
Connector Type	RP-SMA-Male Standard (Other Connectors Available)	
Cable Length	300 cm Standard (Any Cable Length Available)	
Cable Type	DACAR302 Standard (Other Cables Available)	

Antenna Measurement Conditions:

Mounted on 30 x 30 cm Ground Plane
 DACAR302 200 cm Cable Length
 Measured in Certified CTIA 3D Anechoic Chamber

Cable 3

Parameters	GPS/GLONASS Antenna		
	BeiDou	GPS/QZSS/Galileo	GLONASS
Standard			
Band (MHz)	1561	1575	1602
Frequency(MHz)	1561.098	1575.42	1598-1606
Patch Size (mm)		25 x 25 x 4	
Return Loss (dB)		<=-15.0 dB	
VSWR		<=1.4:1 dB	
Impedance		50	
Radiation Pattern		Hemispherical	
Polarization		RHCP	
Saw Filter		Pre-filter	
Active Gain (dB)		28 @ 2.7 V	
Noise Figure (dB)		1.5 Typ	
Voltage (V)		1.5 – 3.6	
Current (mA)		9 Typ	
Power Consumption (mW)		24.3 Typ	
ESD Protection (kV)		2kV	
Connector Type	SMA-Male Standard (Other Connectors Available)		
Cable Length	300 cm Standard (Any Cable Length Available)		
Cable Type	LMR100 Standard (Other Cables Available)		

2. Mechanical and environmental specifications

Specifications	2J6A50BCF
Mounting Type	Screw Mount
Dimensions (mm)	Ø 77.3 x 65.5
Max. Tighten Torque (Nm)	6 Nm
Radome Type	PC/ABS UV Stable
Radome Color	Black or White
Antenna Base	Zamak
Gasket	TPE
Operating Temperature (C)	-40 to +85
Storage Temperature (C)	-40 to +85
Substance Compliance	RoHS
Certificates	IP67, IK09, IP69K

3. Antenna parameters

Cable 1: CELLULAR/LTE

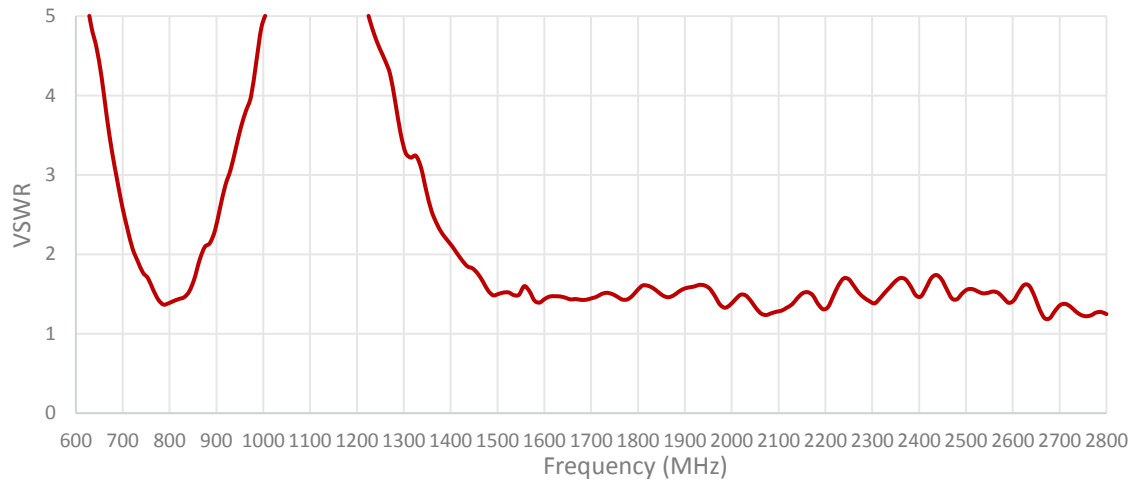
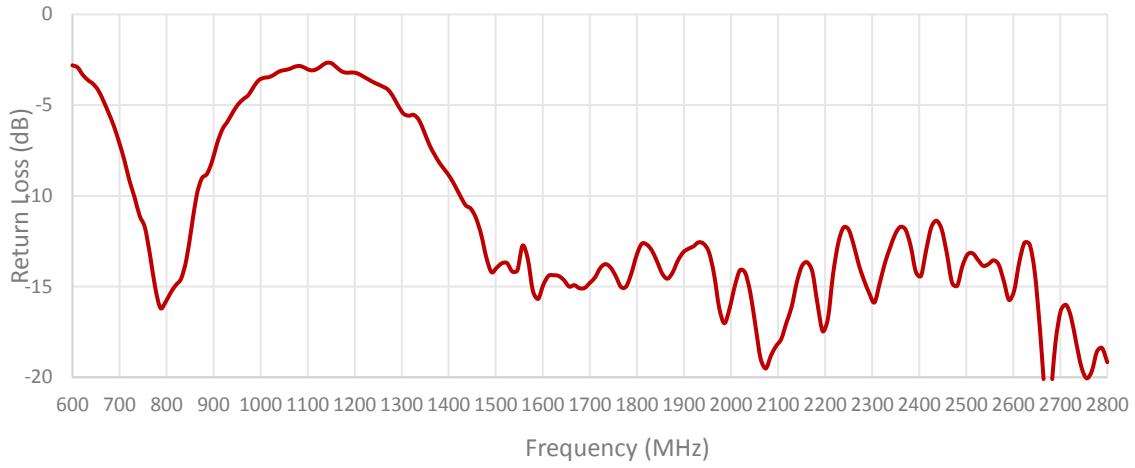

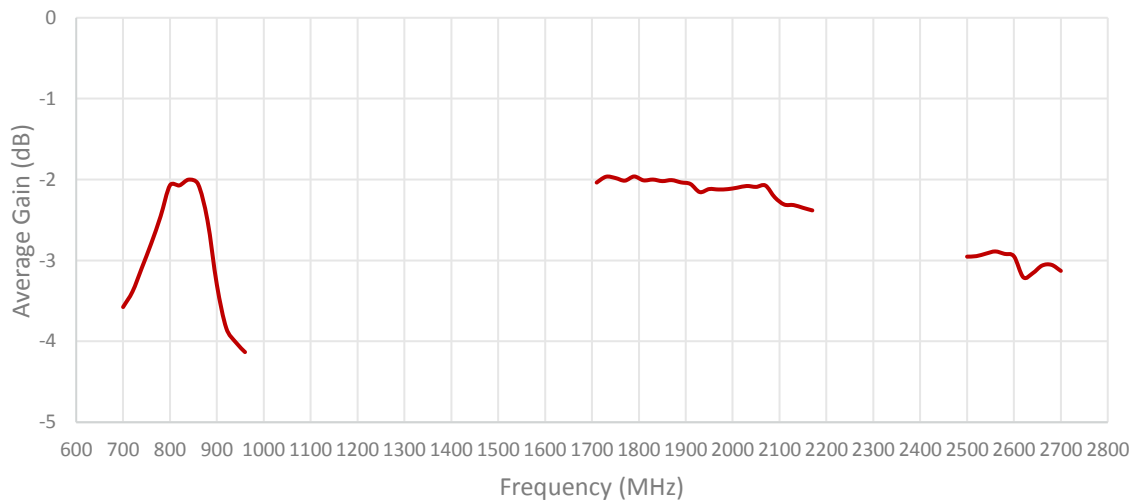
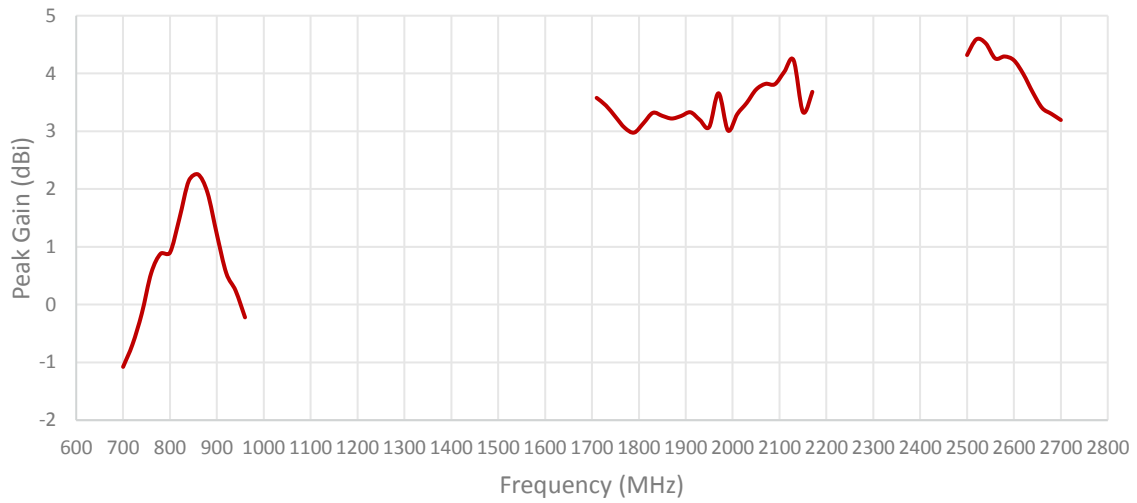
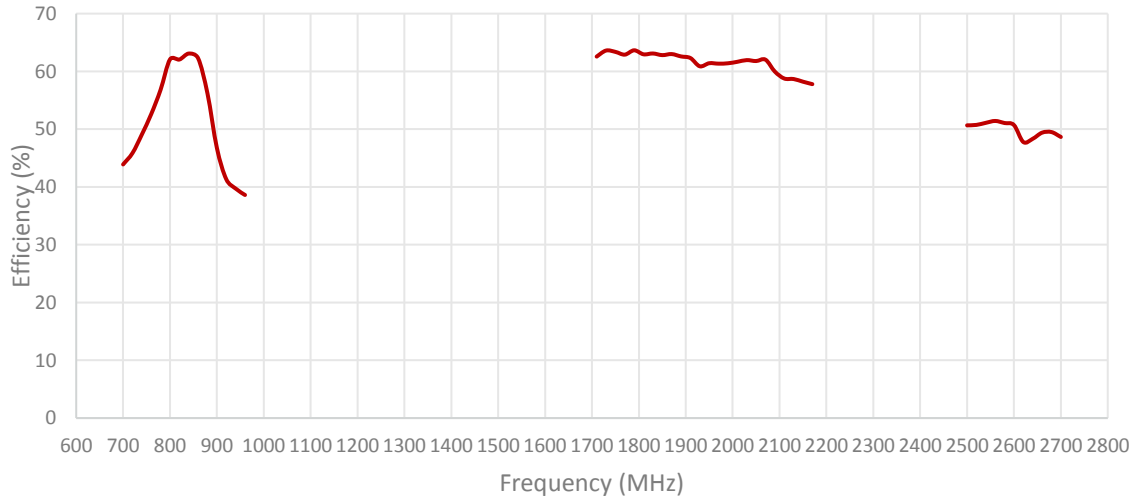

Cable 2: 2.4/5.0 GHz ISM

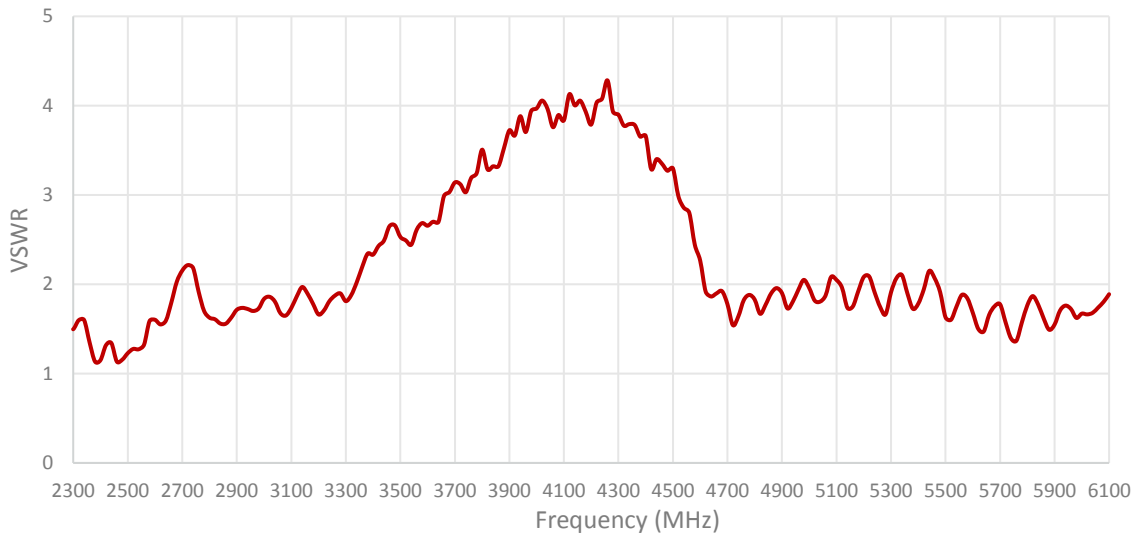
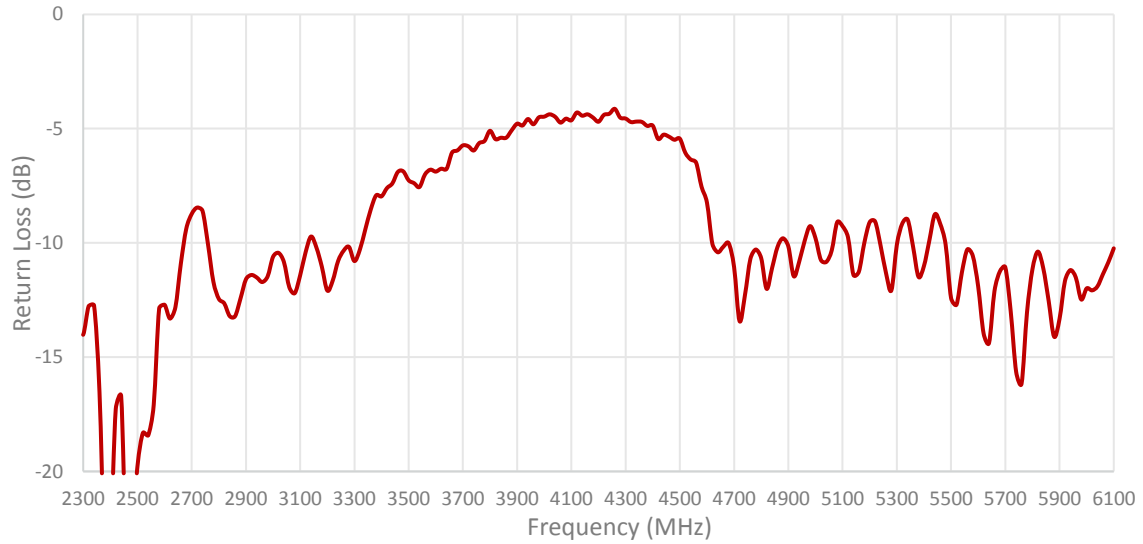

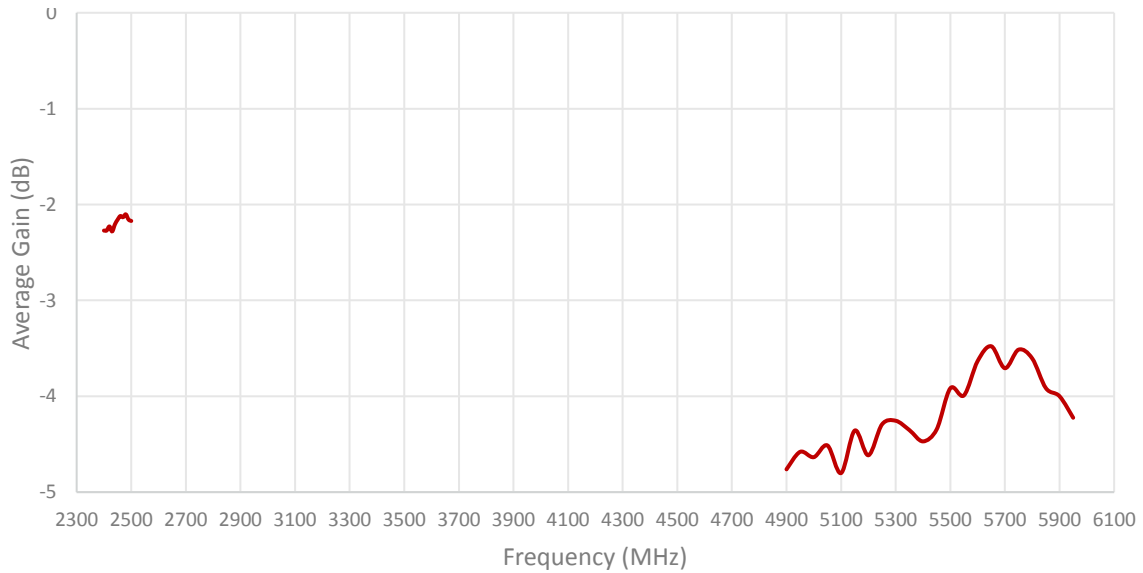
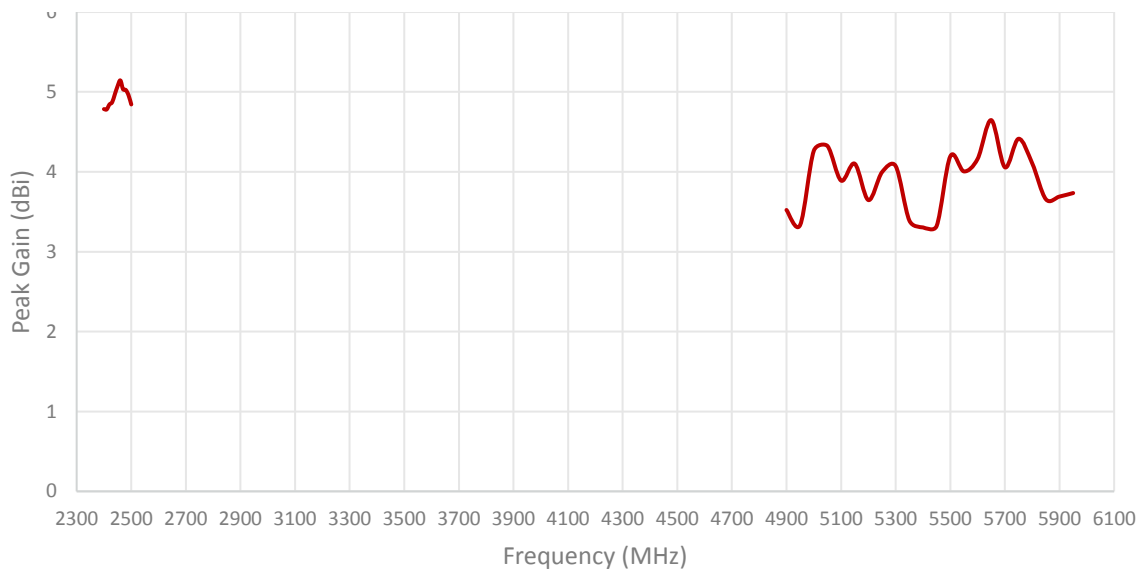
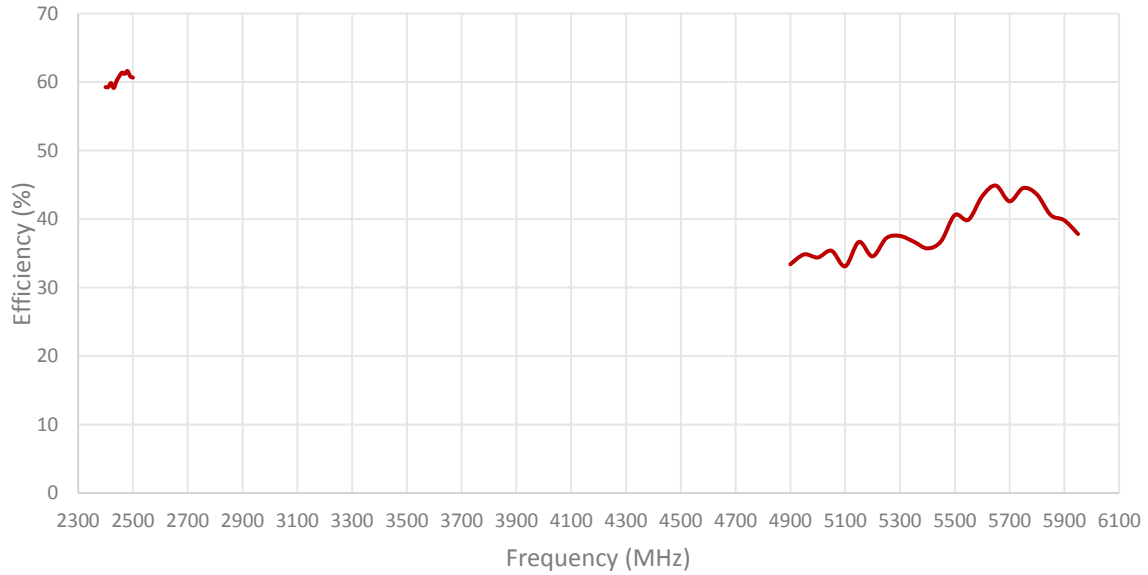

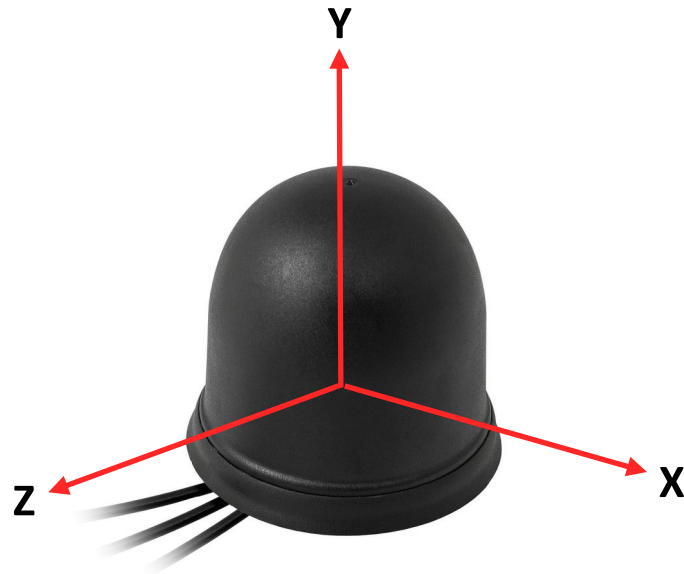

Radiation pattern reference

Table 1: CELLULAR/LTE

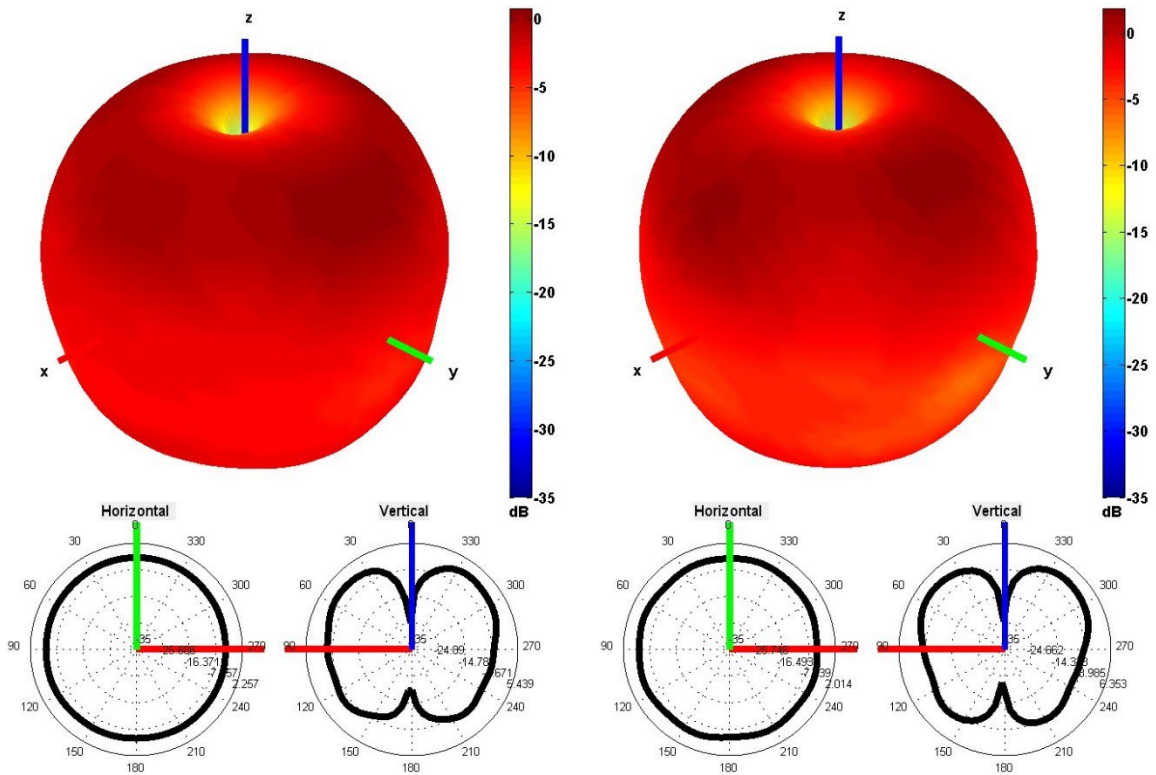

750 and 850 MHz Radiation pattern

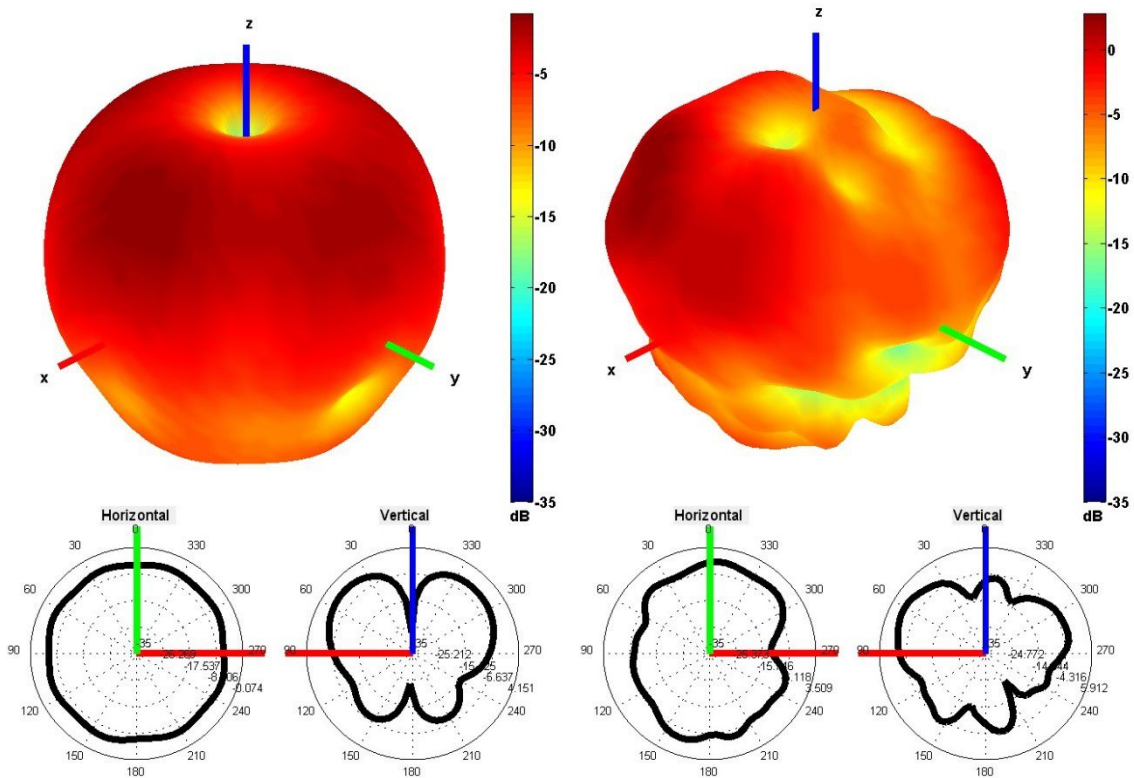

940 and 1750 MHz Radiation pattern

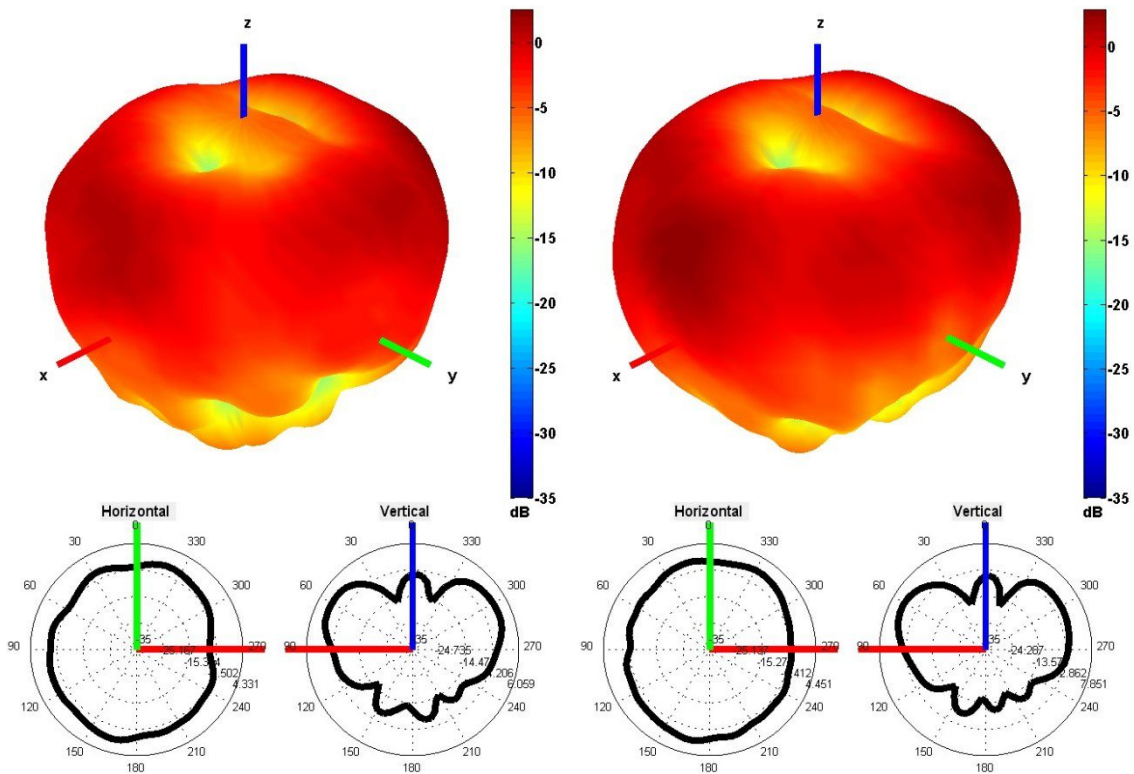

1850 and 1950 MHz Radiation pattern

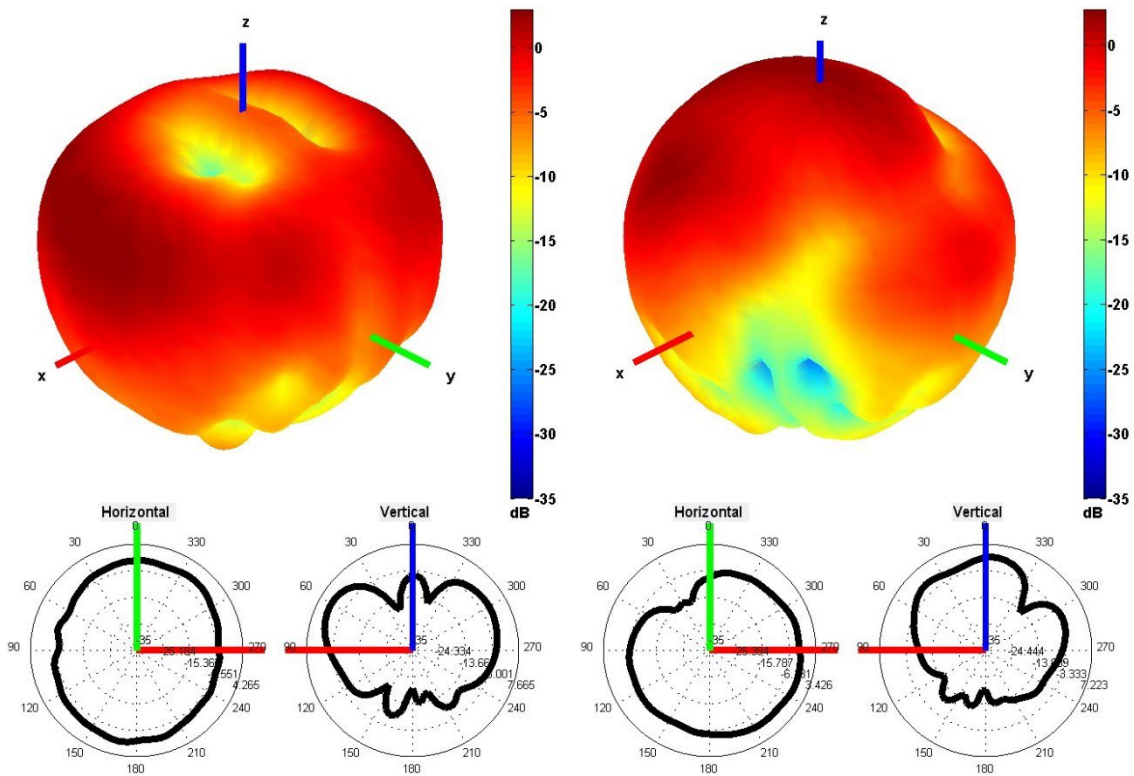

2100 and 2600 MHz Radiation pattern

Table 2: 2.4/5.0 GHz ISM

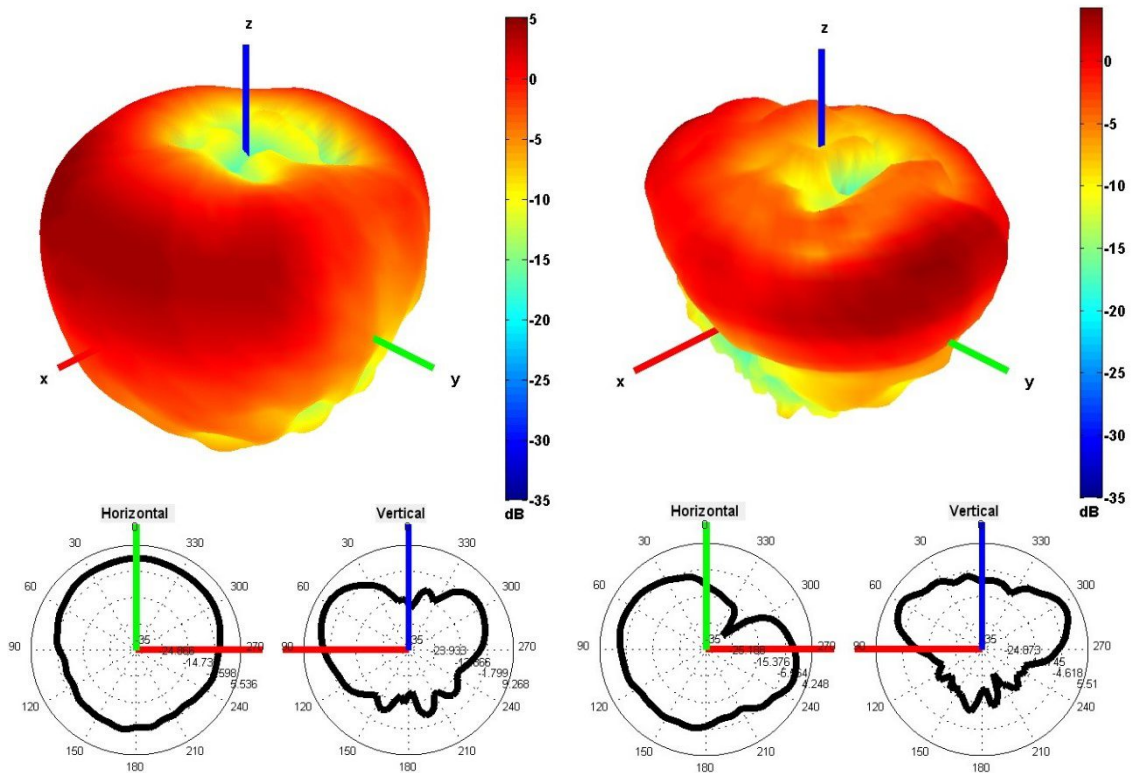

2450 and 5500 MHz Radiation pattern

4. Antenna drawings

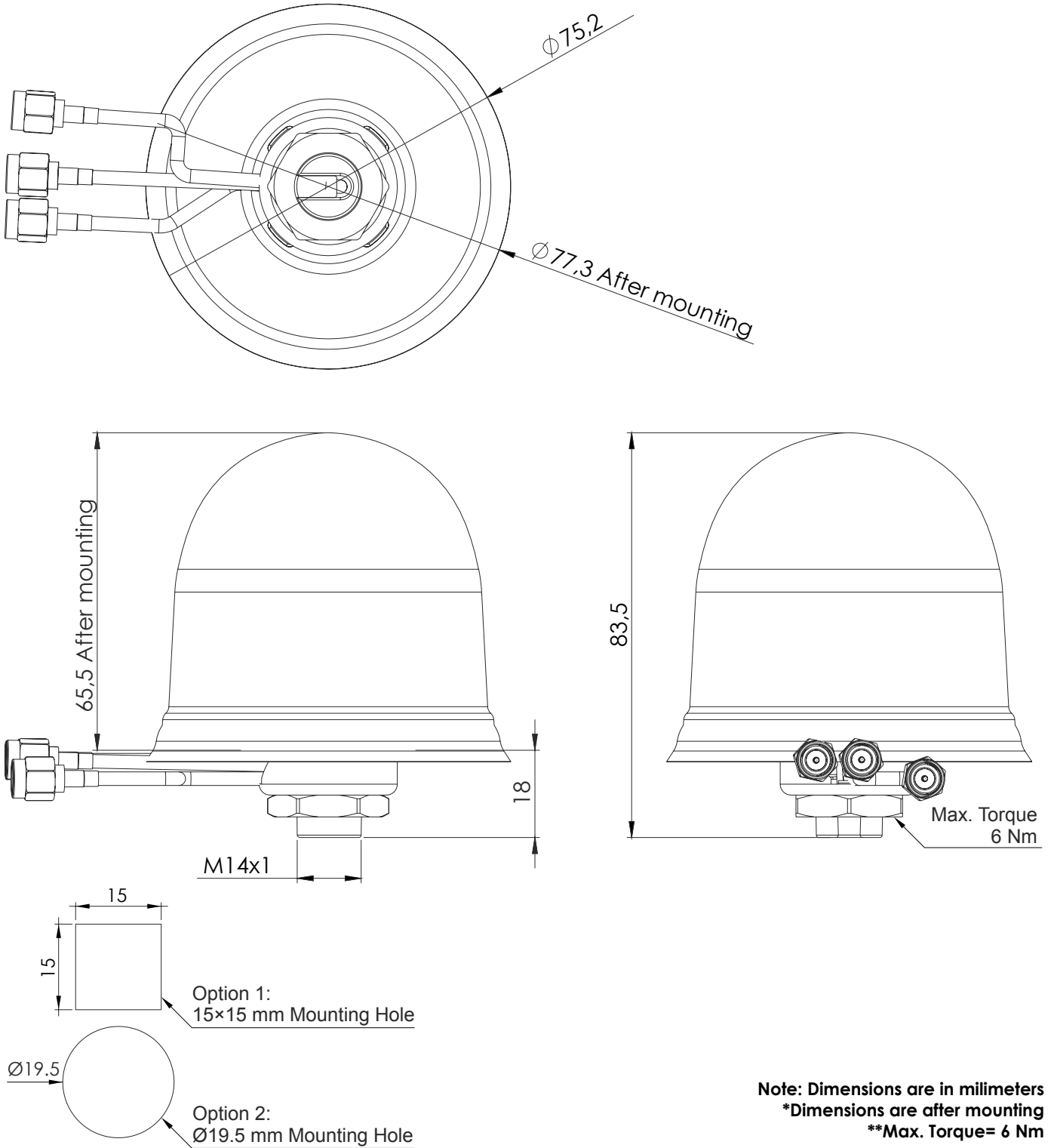

5. Antenna Images

