

2J6986BGF

5GNR, 2.4/5.0/6.0 GHz ISM and GNSS Screw Mount

Key Features

Cable 1: 5GNR

- 617-960 MHz
- 1427-2690 MHz
- 3300-5000 MHz
- 5150-5925 MHz

Cable 2: 2.4/5.0/6.0 GHz ISM

- 2410-2490 MHz
- 4920-5925 MHz
- 5925-7125 MHz

Cable 3: GPS/GLONASS/QZSS/Galileo

- 1575-1606 MHz

Screw Mount

Anti-Rotation Mounting

High Performance

Ground Plane Independent

Customizable Cable and Connector

Dimensions 80 × 74 × 25.6 mm

Certificates: IP67, IP69



1. Antenna and electrical specifications

Cable 1

Parameters	5GNR Antenna			
Technologies	5G, 4G, 3G and 2G			
Standards	5GNR/4GLTE/FirstNet/CBRS/LPWA/CAT-X/CAT-Mx/CAT-NBx/NB-IoT/3G/2G			
Frequency (MHz)	617-960	1427-2690	3300-5000	5150-5925
Band (MHz)	600, 700, 850, 900	1500, 1600, 1700, 1800, 1900, 2000, 2100, 2300, 2500, 2600	3300, 3500, 3600, 3700, 4500	5200, 5500, 5800
5GNR Bands	n5, n8, 12, n20, n28, n71, n81, n82, n83,	n1, n2, n3, n7, n25, n34, n38, n39, n40, n41, n50, n51, n66, n70, n74, n75, n76, n80, n84, n86	n77, n78, n79	
4GLTE Bands	B5, B6, B8, B12, B13, B14, B17, B18, B19, B20, B26, B27, B28, B29, B44, B67, B68, B71, B85	B1, B2, B3, B4, B7, B9, B10, B11, B21, B23, B24, B25, B30, B32, B33, B34, B35, B36, B37, B38, B39, B40, B41, B45, B50, B51, B65, B66, B69, B70, B74, B75, B76	B22, B42, B43, B48, B49, B52	B46, B47, B252, B255
3GCELL Bands	B5, B6, B8, B12, B13, B14, B19, B20, B26	B1, B2, B3, B4, B7, B9, B10, B11, B21, B25, B32, B33, B34, B35, B36, B37, B38, B39, B40	B22	
2GCELL Bands	710, 750, 810T, 850, 900P, 900E, 900R	1800DCS, 1900PCS		
CDMACELL Bands	BC0, BC2, BC3, BC7, BC9, BC10, BC12, BC18, BC19	BC1, BC4, BC6, BC8, BC13, BC14, BC15, BC16, BC20, BC21		
Return Loss (dB)	~-15.5	~-12.1	~-12.3	~-13.0
VSWR	~1.5:1	~1.8:1	~1.9:1	~1.7:1
Efficiency (%)	~35.3	~27.1	~23.6	~22.3
Peak Gain (dBi)	~3.1	~2.7	~0.9	~0.4
Average Gain (dB)	~-4.6	~-5.4	~-6.5	~-6.5
Impedance (Ohm)	50			
Polarisation	Linear			
Radiation Pattern	Omni-Directional			
Max. Input Power (W)	25			
Connector Type	SMA-Male Standard (Other Connectors Available)			
Cable Length	300 cm Standard (Any Cable Length Available)			
Cable Type	D302 Standard (Other Cables Available)			

Cable 2

Parameters	2.4/5.0/6.0 GHz ISM Antenna		
Standards	WiFi, BT, ZigBee, ISM		
Band (MHz)	2.4 GHz	5.0 GHz	6.0 GHz
Frequency (MHz)	2410-2490	4920-5925	5925-7125
Return Loss (dB)	~-11.4	~-18.0	~-18.5
VSWR	~2.0:1	~1.3:1	~1.3:1
Efficiency (%)	~24.7	~27.4	~25.4
Peak Gain (dBi)	~-0.2	~1.7	~1.6
Average Gain (dB)	~-6.1	~-5.6	~-5.8
Impedance (Ohm)	50		
Polarisation	Linear		
Radiation Pattern	Omni-Directional		
Max. Input Power (W)	25		
Connector Type	SMA-Male RP Standard (Other Connectors Available)		
Cable Length	300 cm Standard (Any Cable Length Available)		
Cable Type	D302 Standard (Other Cables Available)		

Cable 3

Parameters	GNSS Ceramic Active Antenna	
Standards	GPS/QZSS/Galileo	GLONASS
Bands (MHz)	1575	1602
Frequency (MHz)	1575.42	1598-1606
Passive Gain (dBi)	~3.6	
Impedance (Ohms)	50	
Radiation Pattern	Hemispherical	
Voltage Range (V)	1.5 - 3.6	
Active Gain (dB)	28 @ 2.7 V	
Noise Figure (dB)	1.8 @ 2.7 V	
Current Consumption (mA)	9 @ 2.7 V	
Power Consumption (mW)	24.3 @ 2.7 V	
Saw Filter Type	Pre-Filter	
Out of Band Rejection (dB)	~43	
ESD Protection (kV)	6	
Connector Type	SMA-Male Standard (Other Connectors Available)	
Cable Length	300 cm Standard (Any Cable Length Available)	
Cable Type	D100 Standard (Other Cables Available)	

Antenna Measurement Conditions:

Mounted on Metal Plate of 30 x 30 cm

100 cm of Cable D302

Measured in Certified CTIA 3D Anechoic Chamber

2. Mechanical and environmental specifications

Specifications	2J6986BGF
Mounting Type	Screw Mount
Dimensions (mm)	80 × 74 × 25.6
Max. Tighten Torque (Nm)	5 Nm
Radome Type	PC/ASA
Radome Color	Black, White
Operating Temperature (C)	-40 to +85
Storage Temperature (C)	-40 to +85
Substance Compliance	RoHS
Certificates	IP67, IP69

3. Antenna parameters

Cable 1: 5GNR

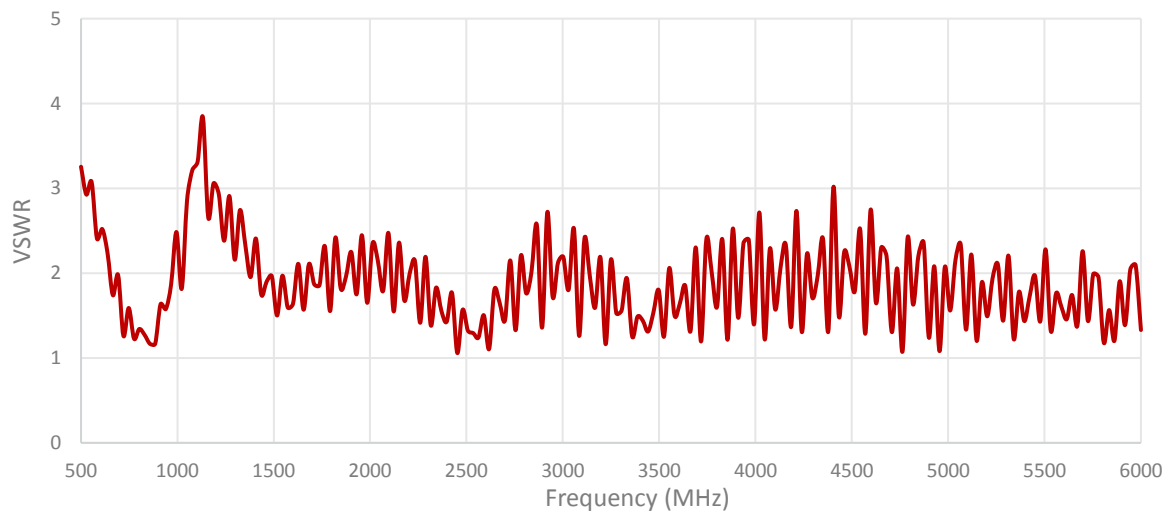
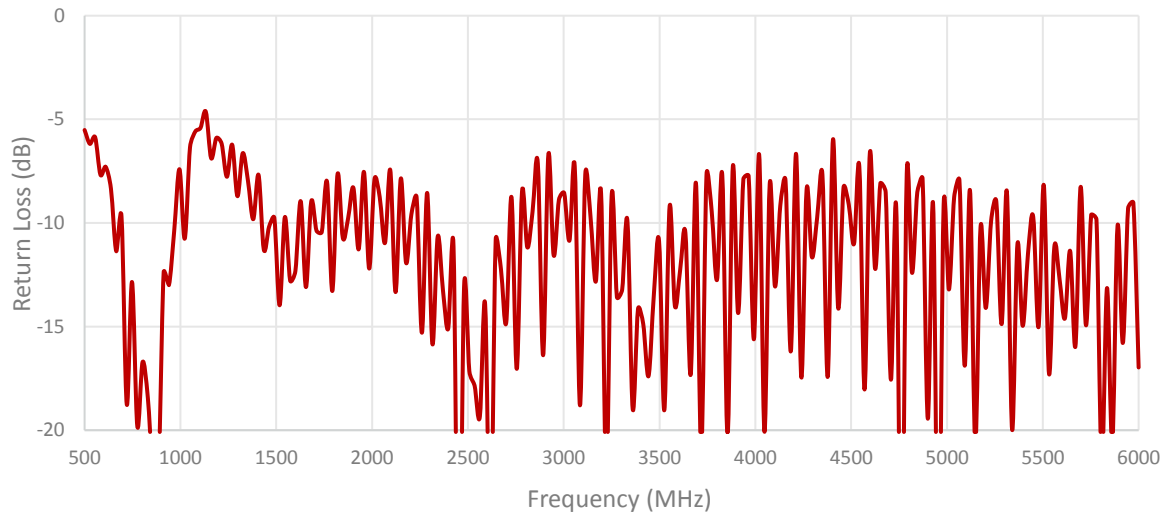

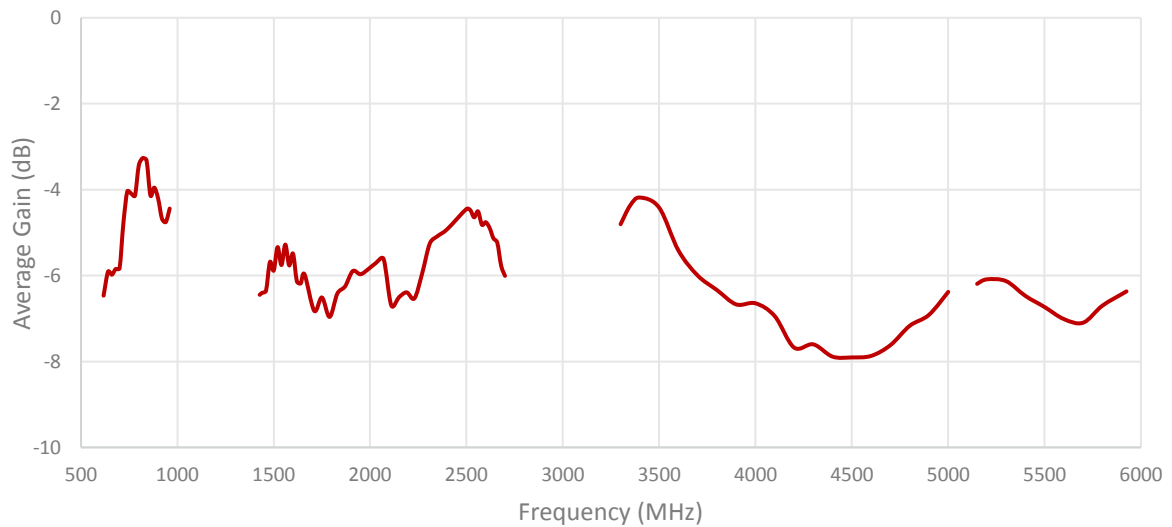
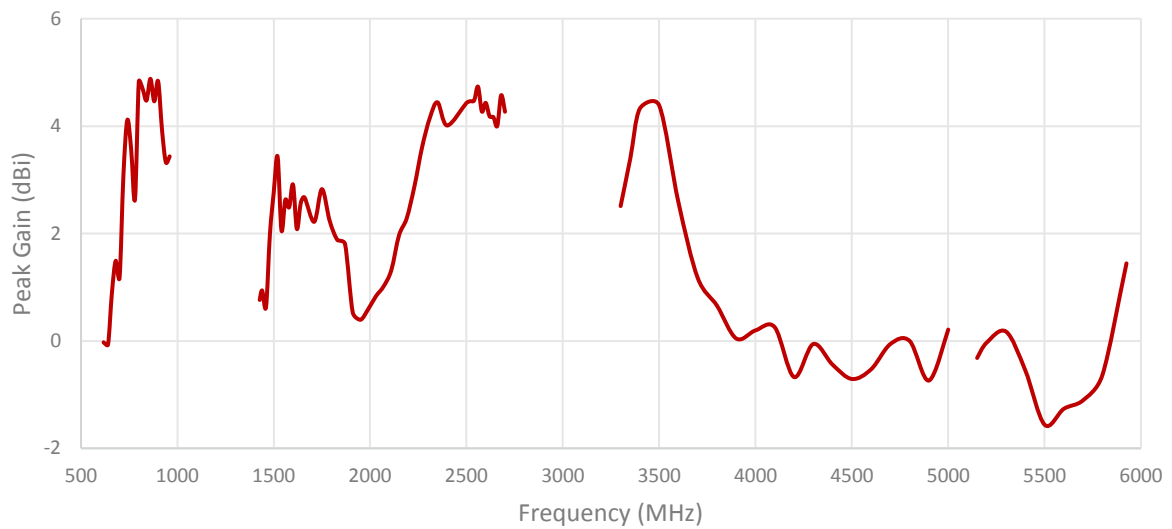
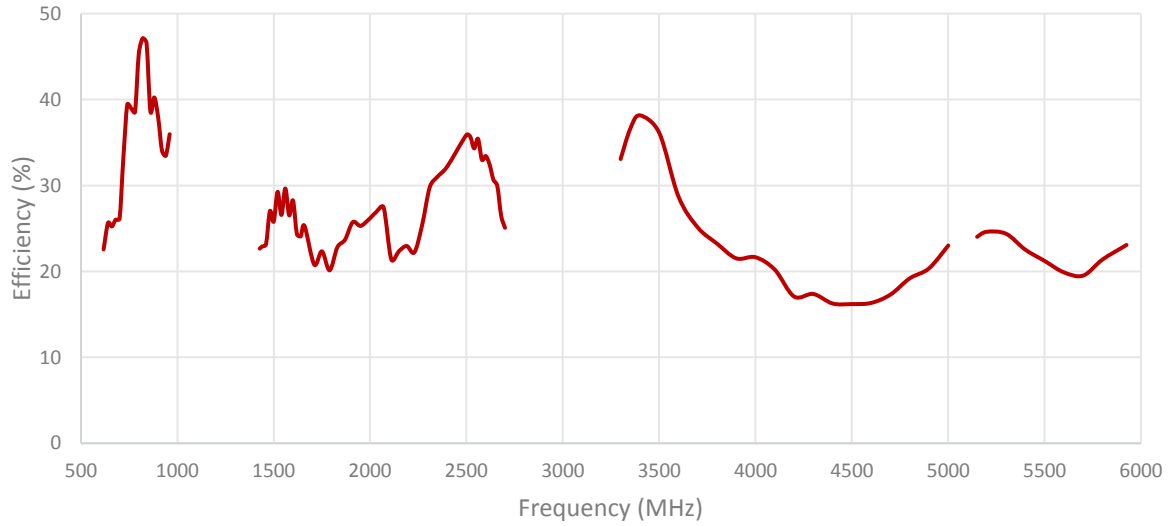

Cable 2: 2.4/5.0/6.0 GHz ISM

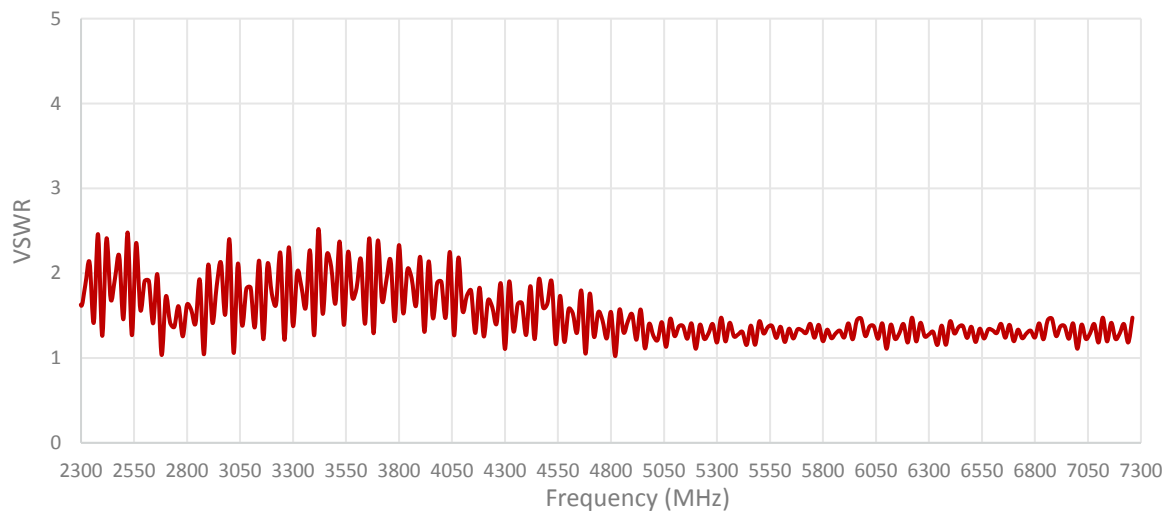
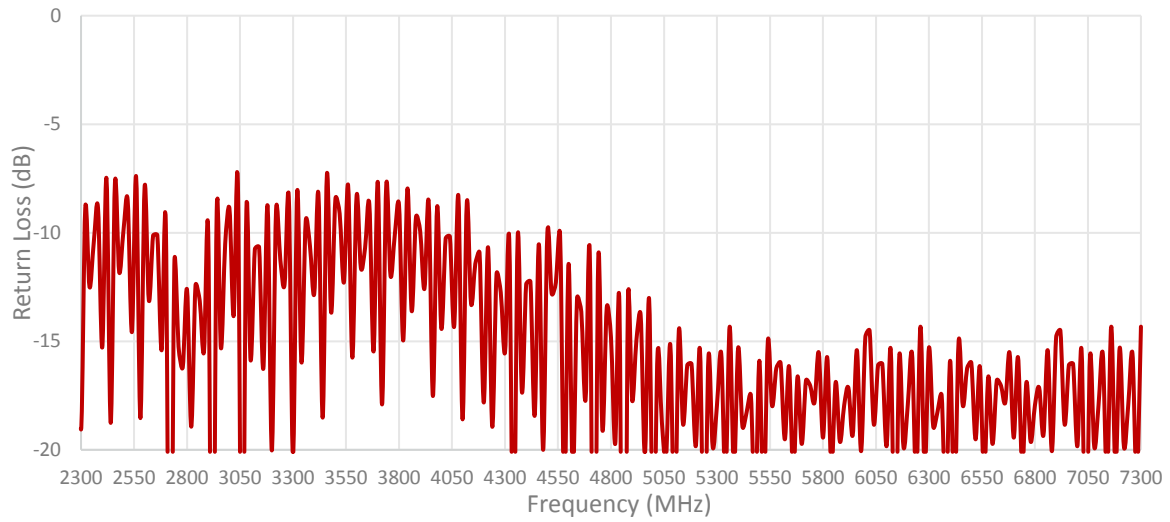

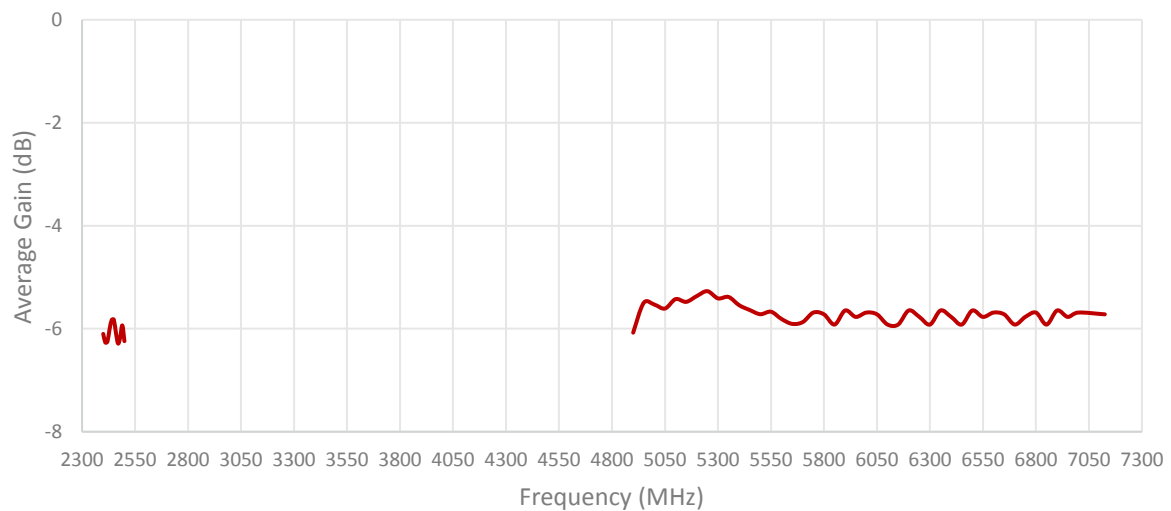
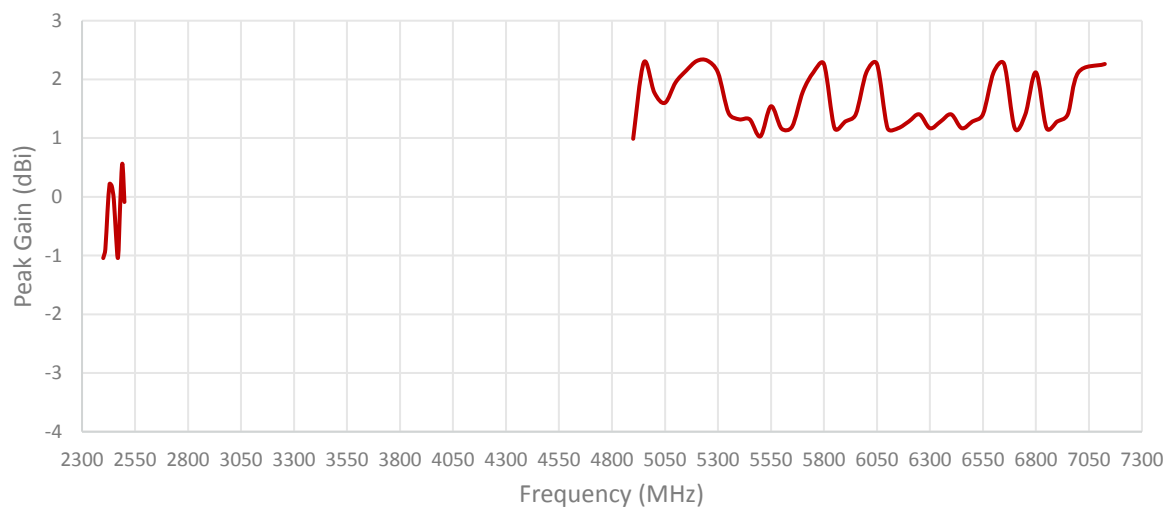
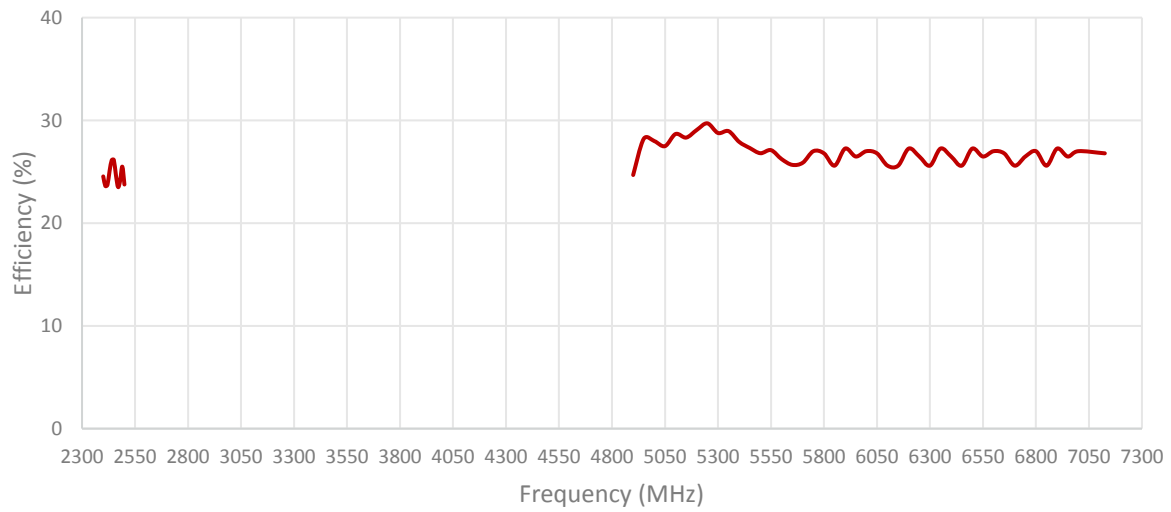

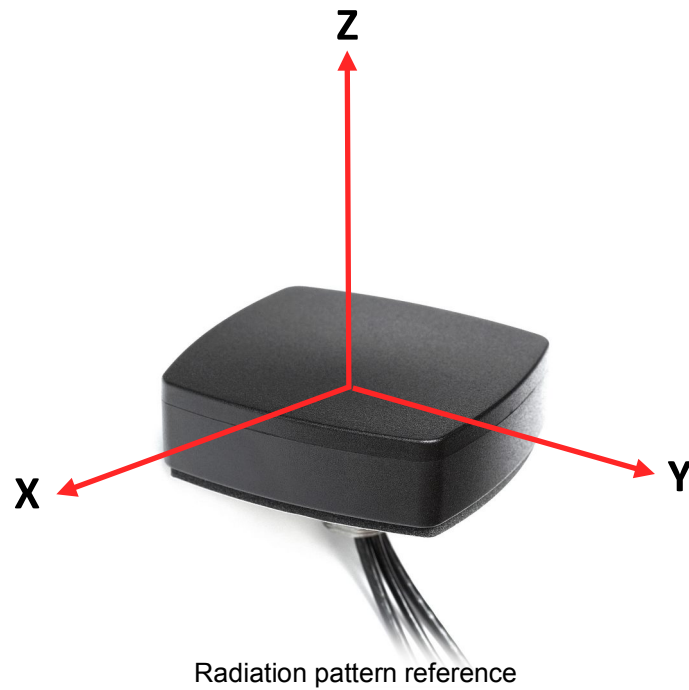

Cable 1: 5GNR

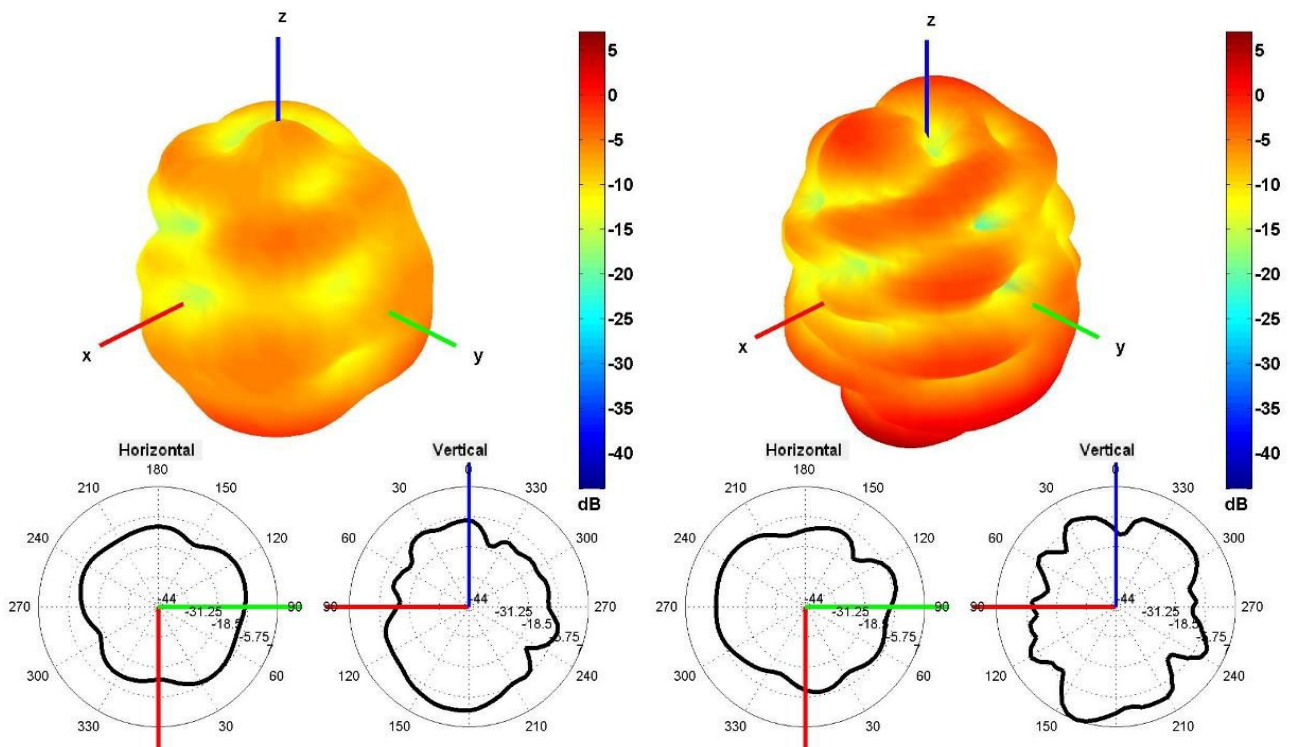

640 and 740 MHz Radiation pattern

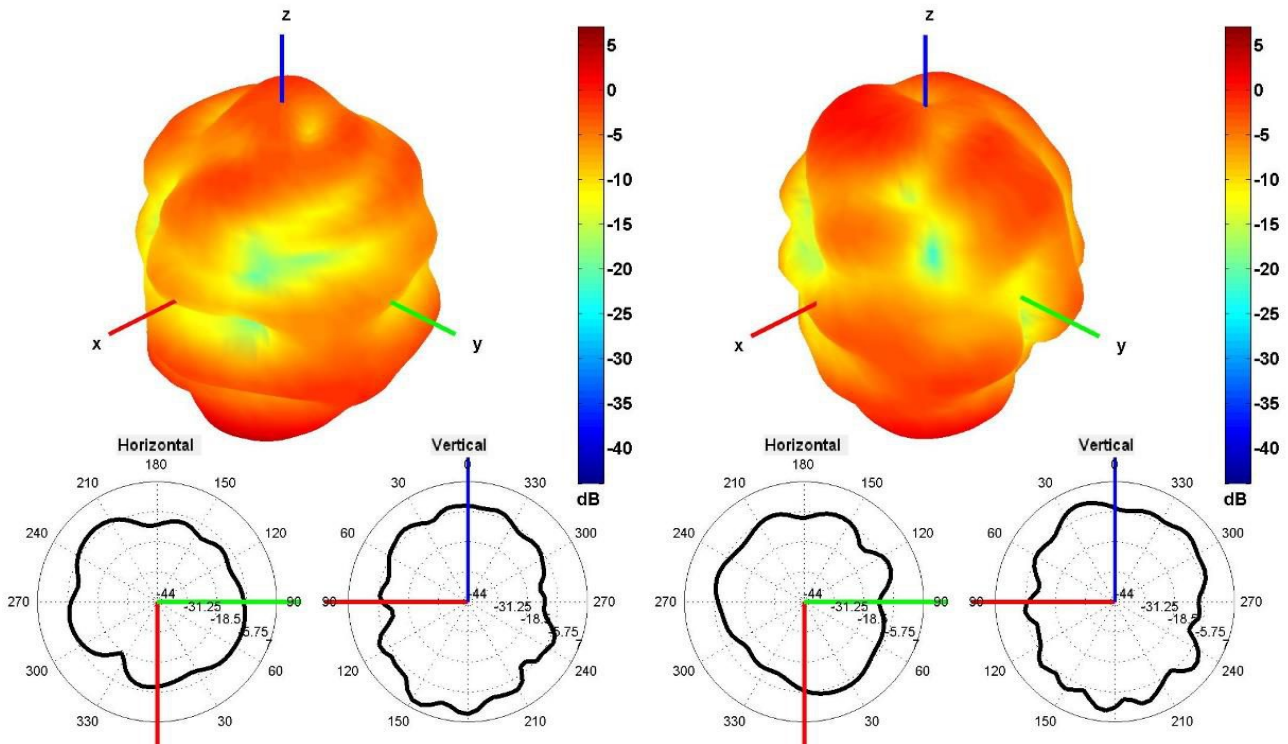

850 and 940 MHz Radiation pattern

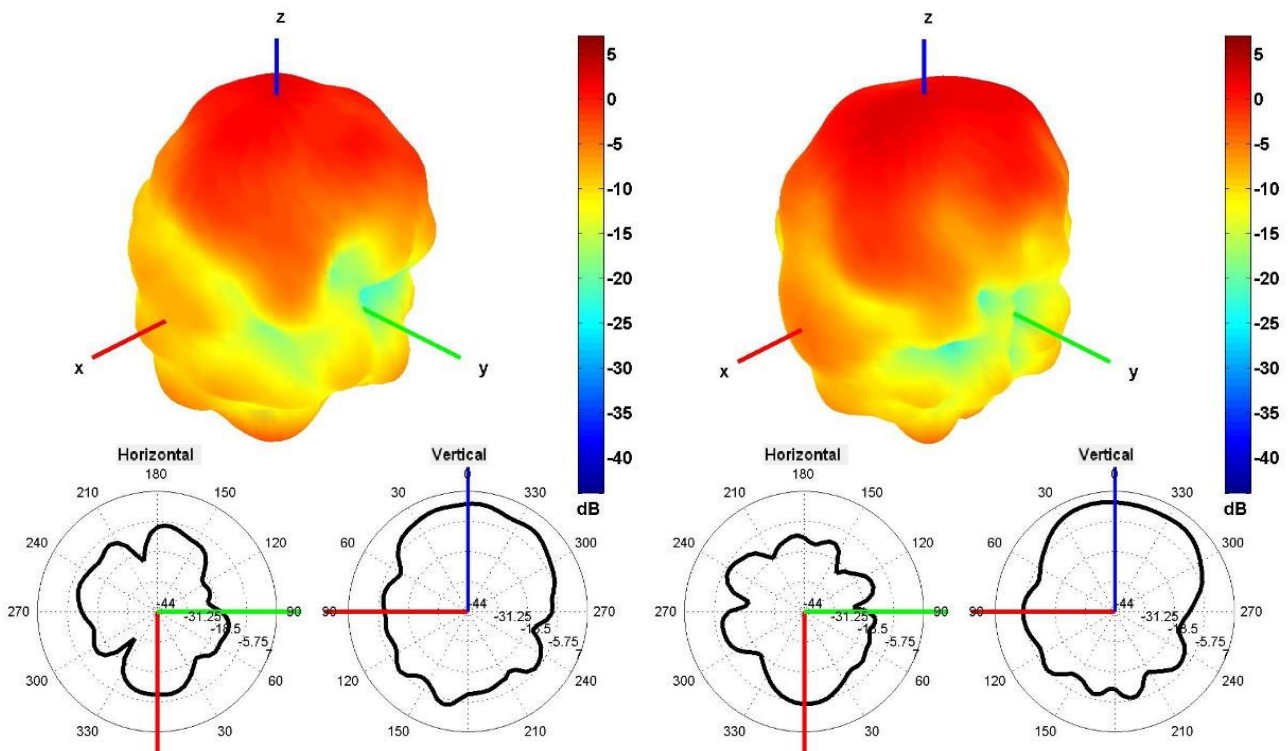

1500 and 1600 MHz Radiation pattern

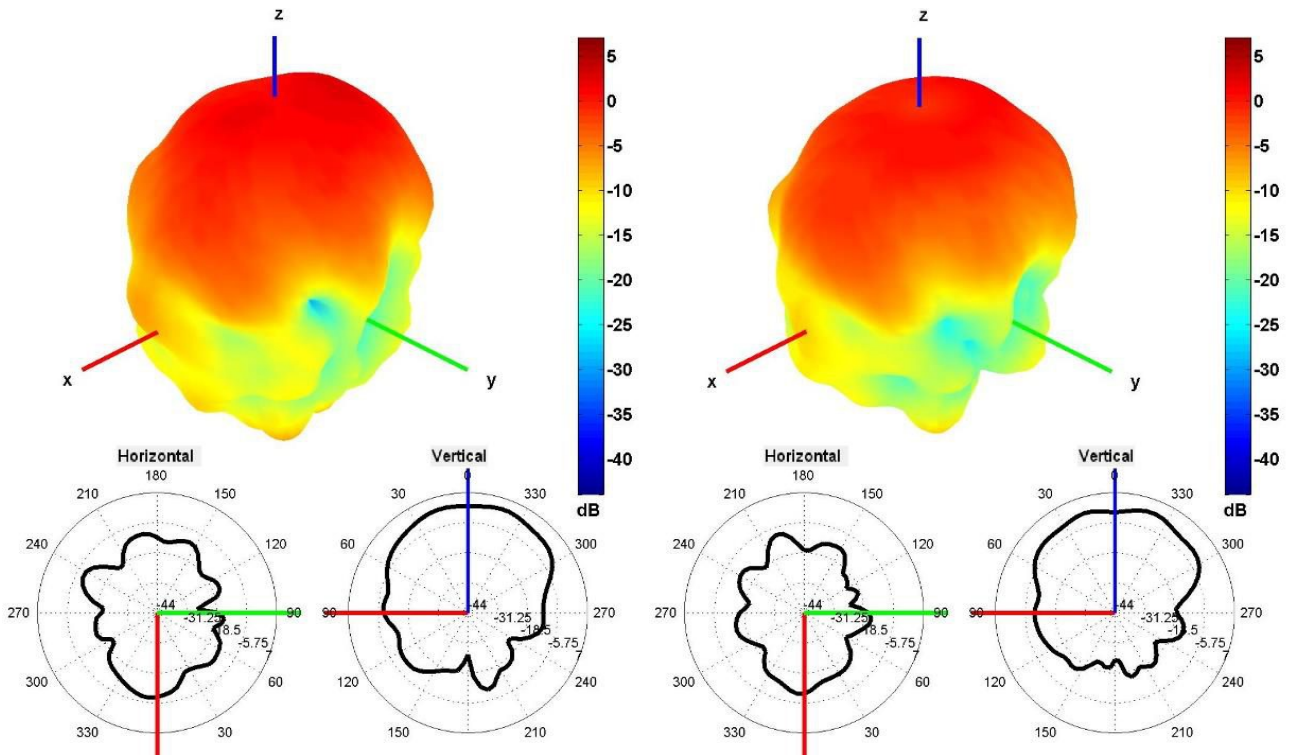

1750 and 1850 MHz Radiation pattern

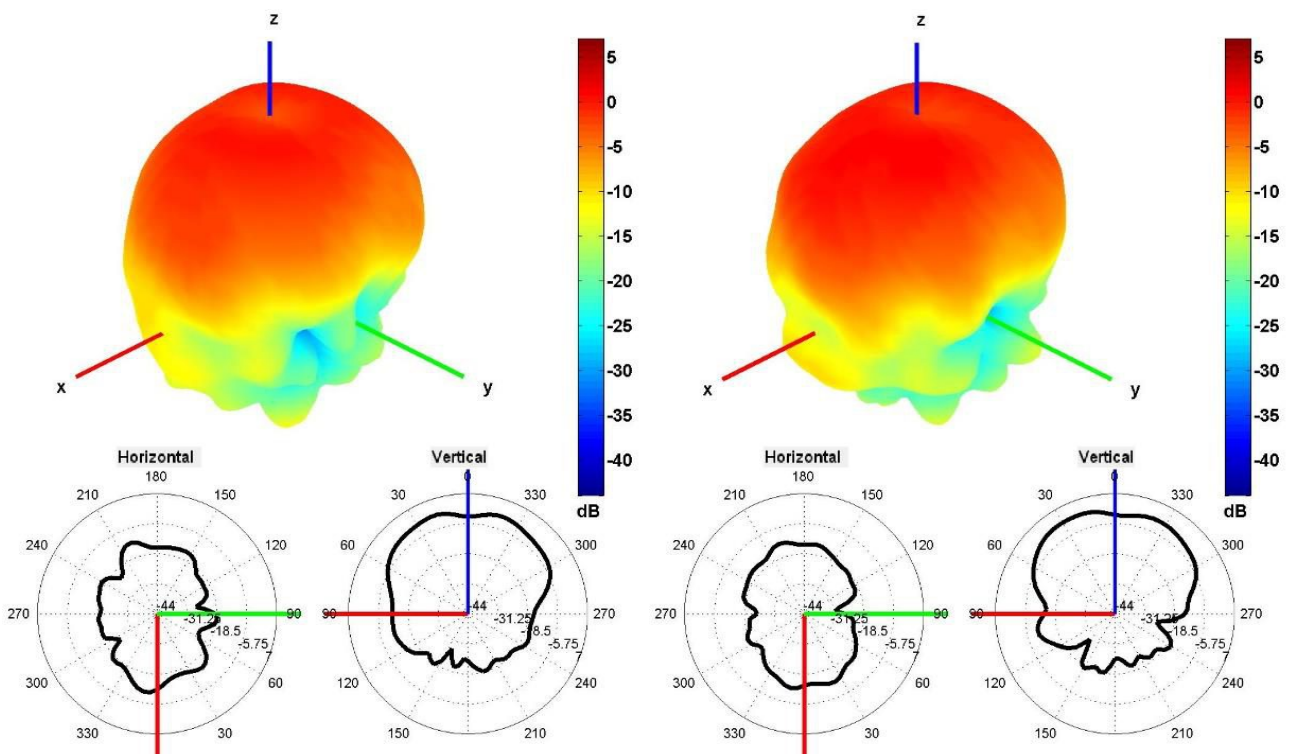

1950 and 2100 MHz Radiation pattern

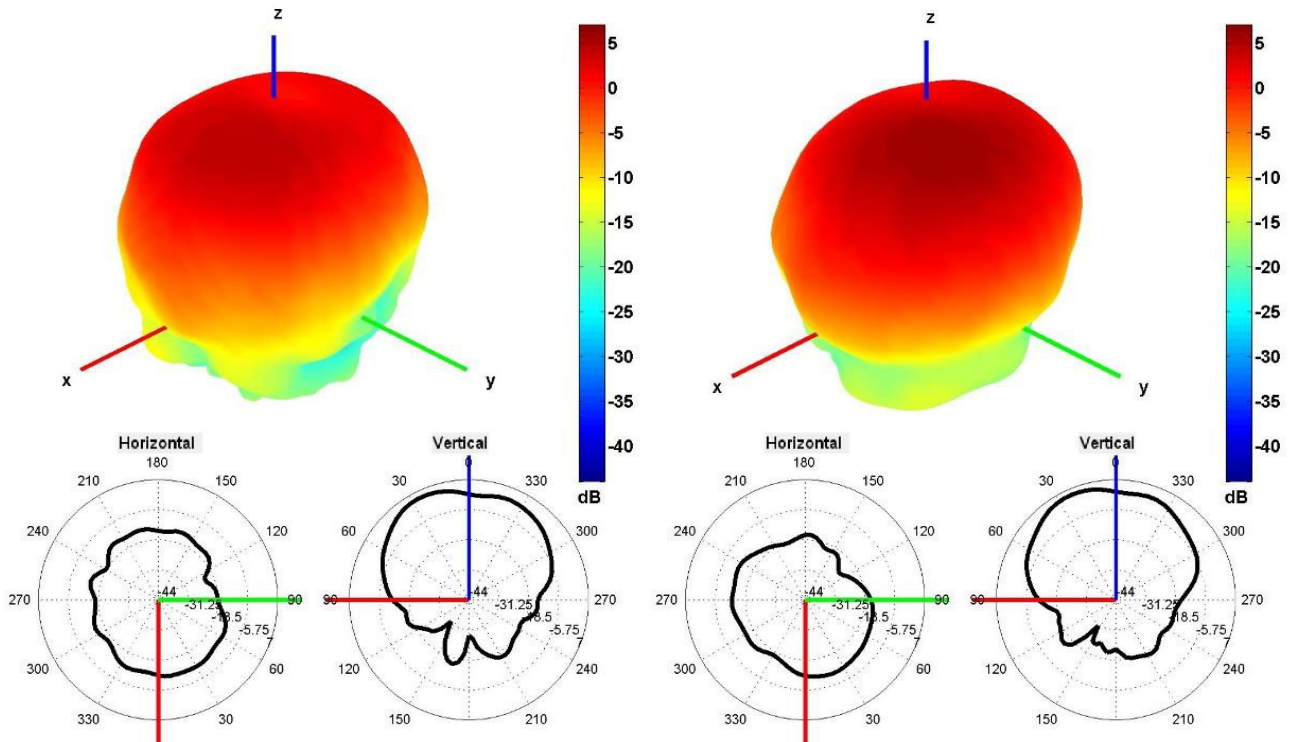

2350 and 2600 MHz Radiation pattern

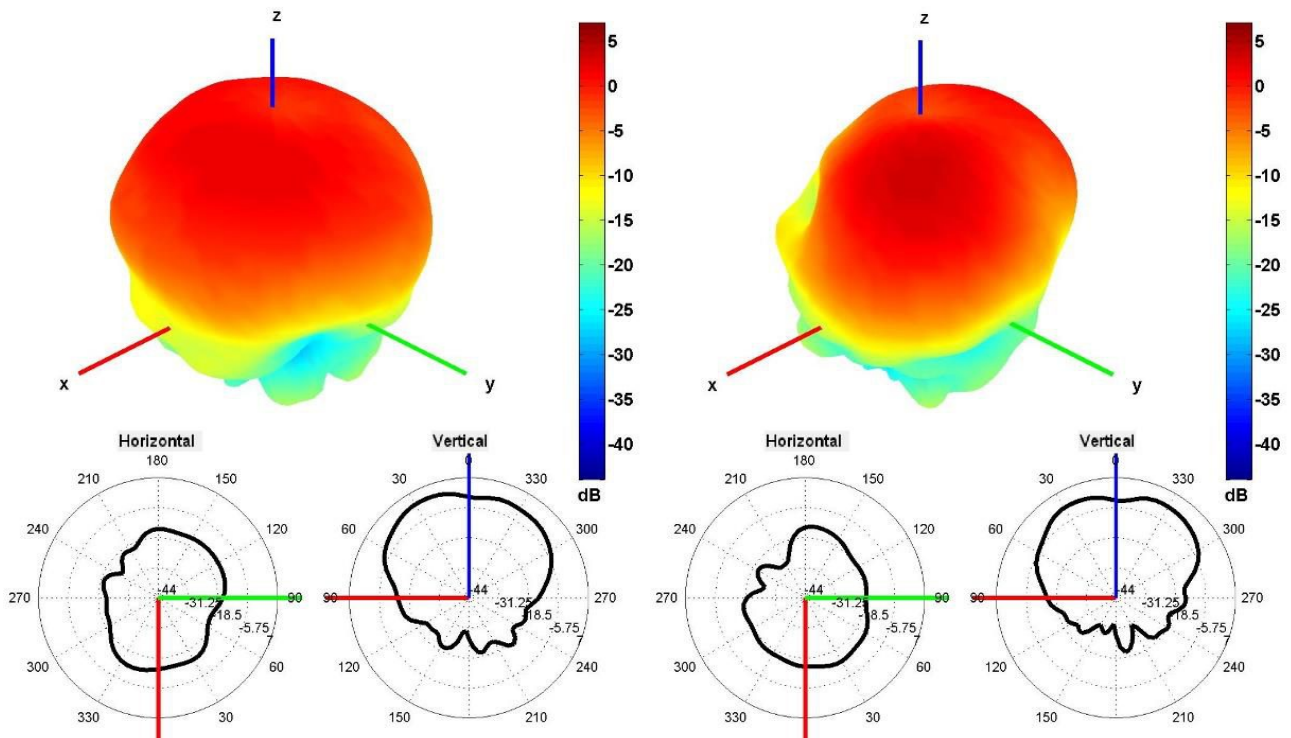

3350 and 3600 MHz Radiation pattern

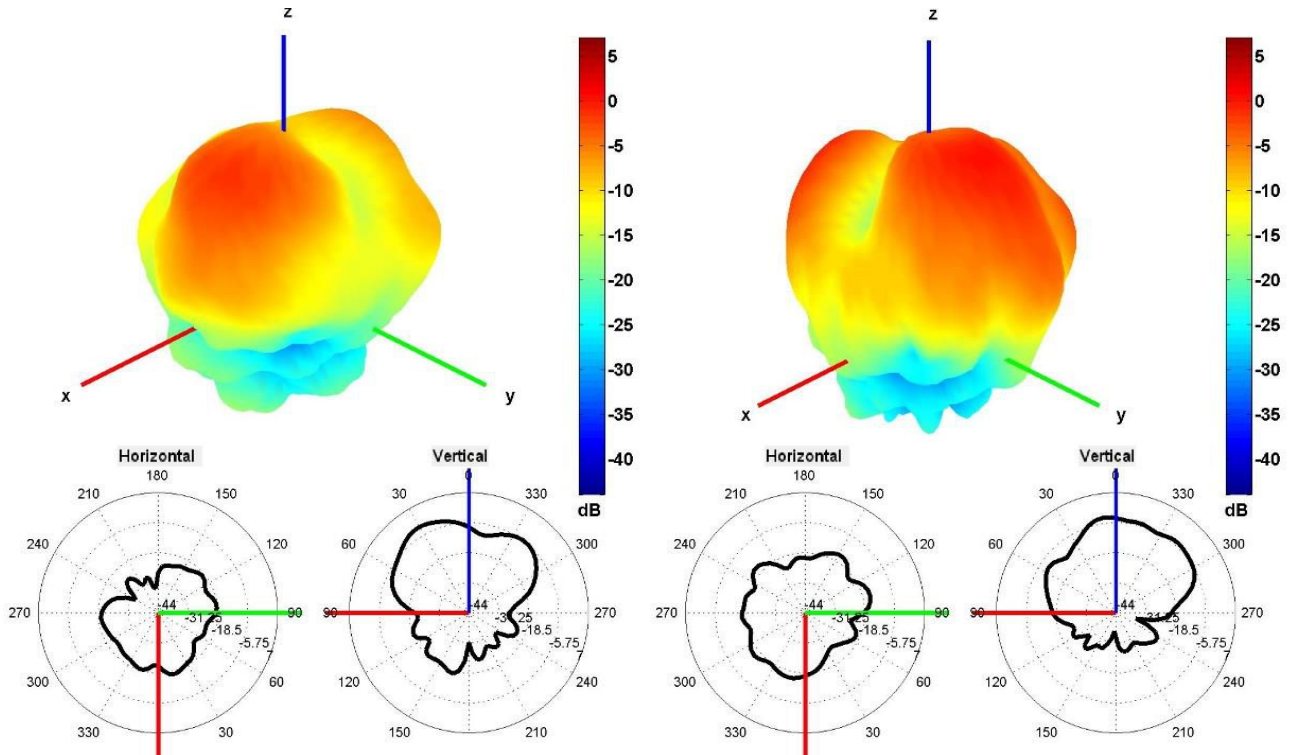

4500 and 5500 MHz Radiation pattern

Cable 2: 2.4/5.0/6.0 GHz ISM

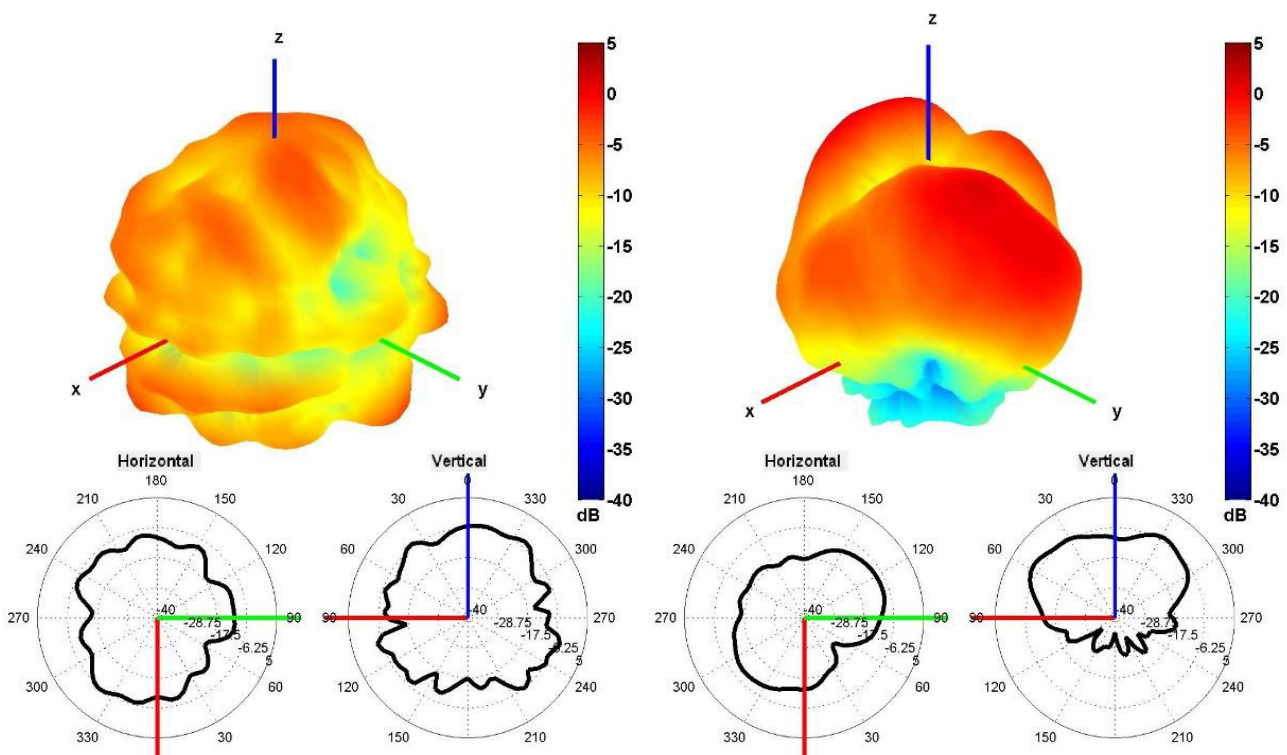

2450 and 5500 MHz Radiation pattern

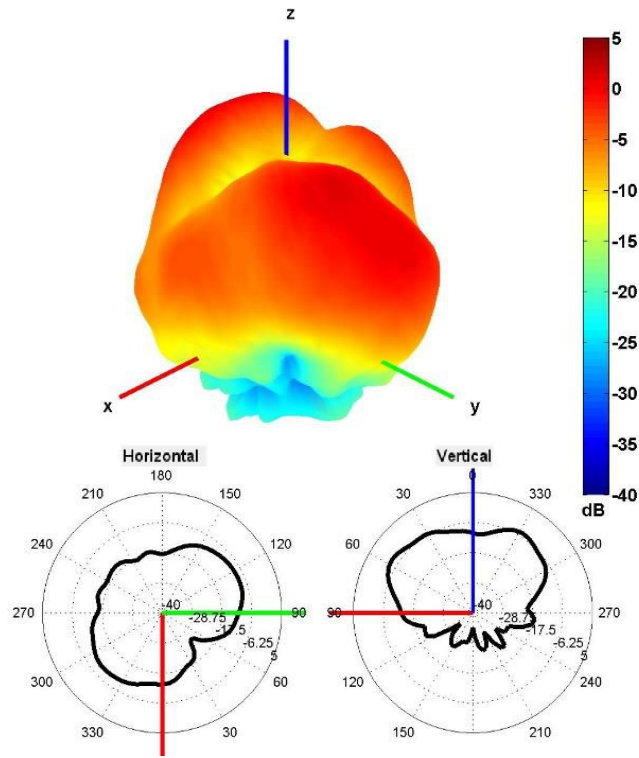

6500 MHz Radiation pattern

4. Antenna drawings

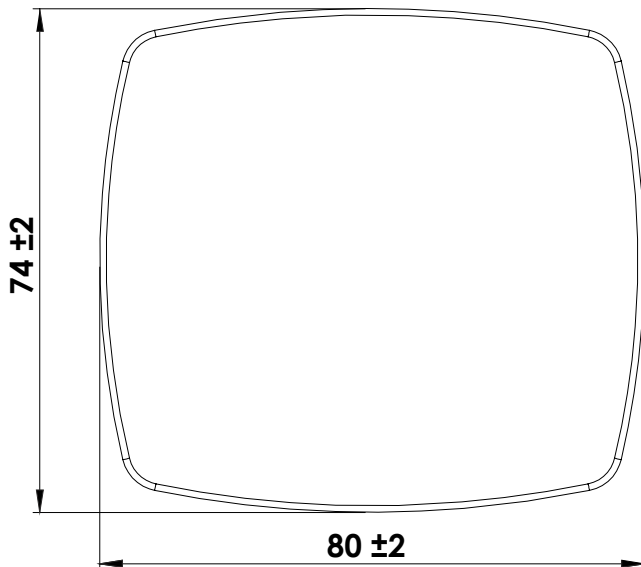
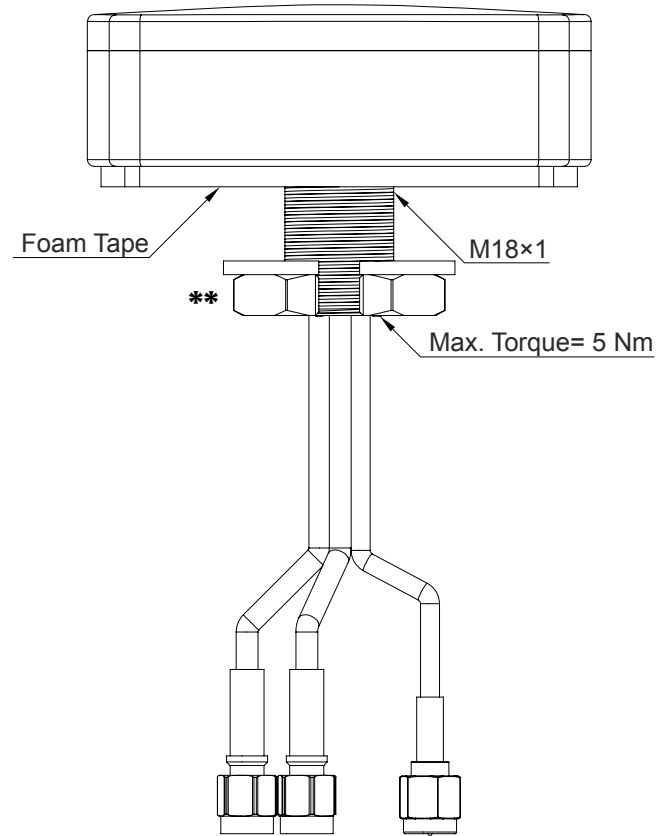
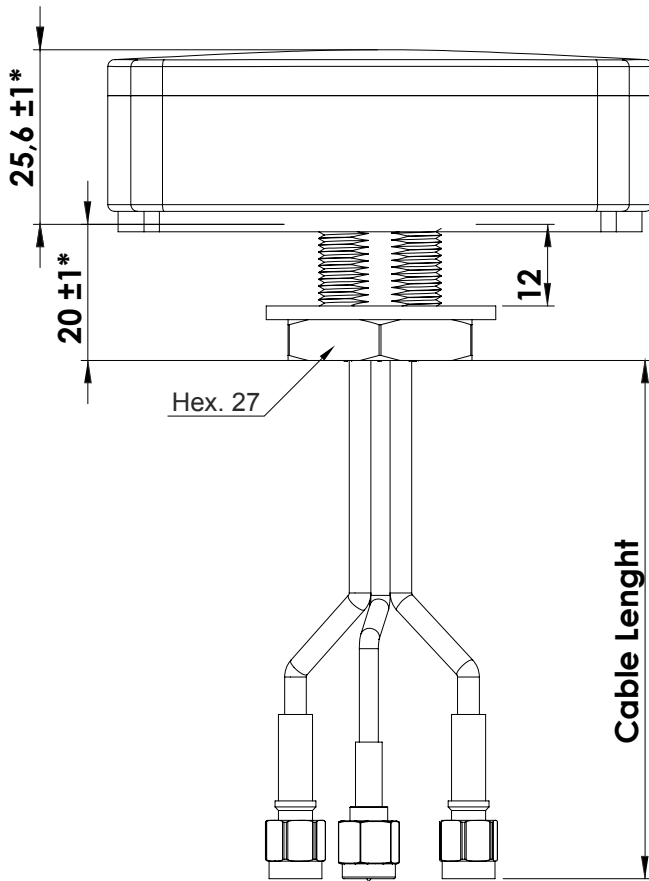

Mounting hole

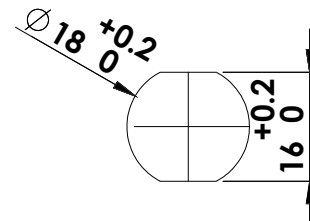

Max. mounting thickness 12mm
 Note: Dimensions are in millimeters
 *Dimensions are after mounting
 **Max. Torque= 5 Nm

5. Antenna Images

