

2J6941PGF

CELLULAR/LTE and GNSS Adhesive Mount

Key Features

Cable 1: CELLULAR / LTE

- 698-960 MHz
- 1710-2170 MHz
- 2500-2700 MHz

Cable 2: GPS/GLONASS/QZSS/Galileo

- 1575-1606 MHz

Adhesive Mount

Low Profile

High Gain

Ground Plane Independent

Customizable Cable and Connector

Dimensions 89 × 76 × 30 mm

Certificates: IP67, IP69



1. Antenna and electrical specifications

Cable 1

Parameters	CELLULAR / LTE Antenna		
Standards	2G,3G and 4G		
Band (MHz)	700/850/900	1700/1800/1900/2100	2600
Frequency (MHz)	698-960	1710-2170	2500-2700
Return Loss (dB)	~-10.6	~-10.5	~-20.6
VSWR	~1.9:1	~1.9:1	~1.3:1
Efficiency (%)	~55.9	~50.6	~60.3
Peak Gain (dBi)	~-4.2	~-5.6	~-5.8
Average Gain (dB)	~-2.5	~-3.1	~-2.4
Impedance (Ohm)	50		
Polarisation	Linear		
Radiation Pattern	Omni-Directional		
Max. Input Power (W)	25		
Connector Type	SMA-Male Standard (Other Connectors Available)		
Cable Length	300 cm Standard (Any Cable Length Available)		
Cable Type	D302 Standard (Other Cables Available)		

Cable 2

Parameters	GPS/GLONASS Antenna	
Standard	GPS/QZSS/Galileo	GLONASS
Band (MHz)	1575	1602
Frequency(MHz)	1575.42	1598-1606
Patch Size (mm)	25 x 25 x 4	
Return Loss (dB)	<=-15.0 dB	
VSWR	<=1.4:1 dB	
Impedance	50	
Radiation Pattern	Hemispherical	
Polarization	RHCP	
Saw Filter	Pre-filter	
Active Gain (dB)	28 @ 2.7 V	
Noise Figure (dB)	1.5 Typ	
Voltage (V)	1.5 – 3.6	
Current (mA)	9 Typ	
Power Consumption (mW)	24.3 Typ	
ESD Protection (kV)	2kV	
Connector Type	SMA-Male Standard (Other Connectors Available)	
Cable Length	300 cm Standard (Any Cable Length Available)	
Cable Type	LMR100 Standard (Other Cables Available)	

Antenna Measurement Conditions:

Mounted on 30 x 30 x 0.25 cm ABS Plate

200 cm of Cable D302

Measured in Certified CTIA 3D Anechoic Chamber

2. Mechanical and environmental specifications

Specifications	2J6941PGF
Mounting Type	Adhesive Mount
Dimensions (mm)	89 x 76 x 30
Radome	ASA
Radome color	Black or White
Operating Temperature (C)	-40 to +85
Storage Temperature (C)	-40 to +85
Substance Compliance	RoHS

3. Antenna parameters

Cable 1: CELLULAR/LTE

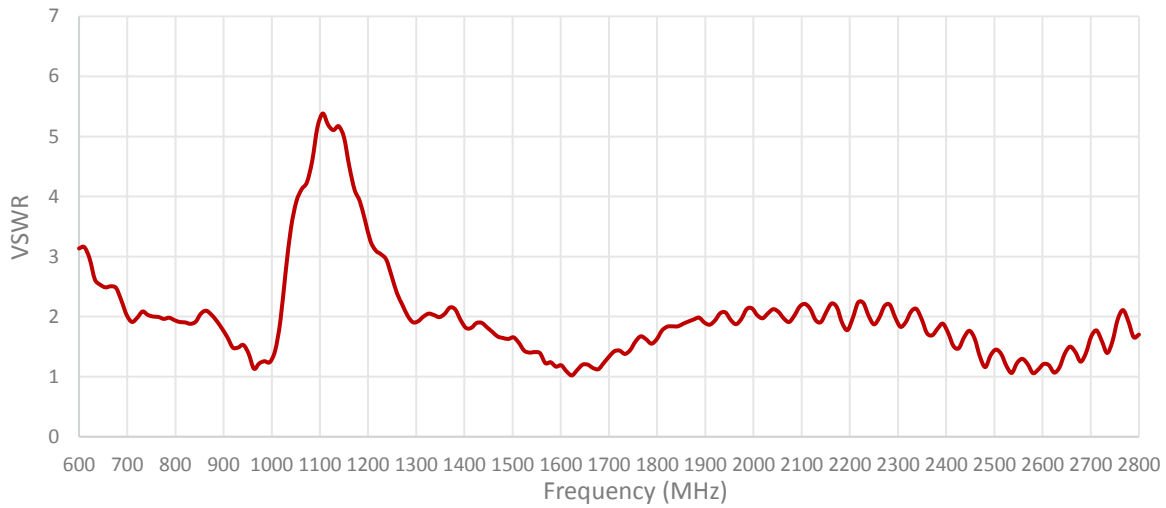
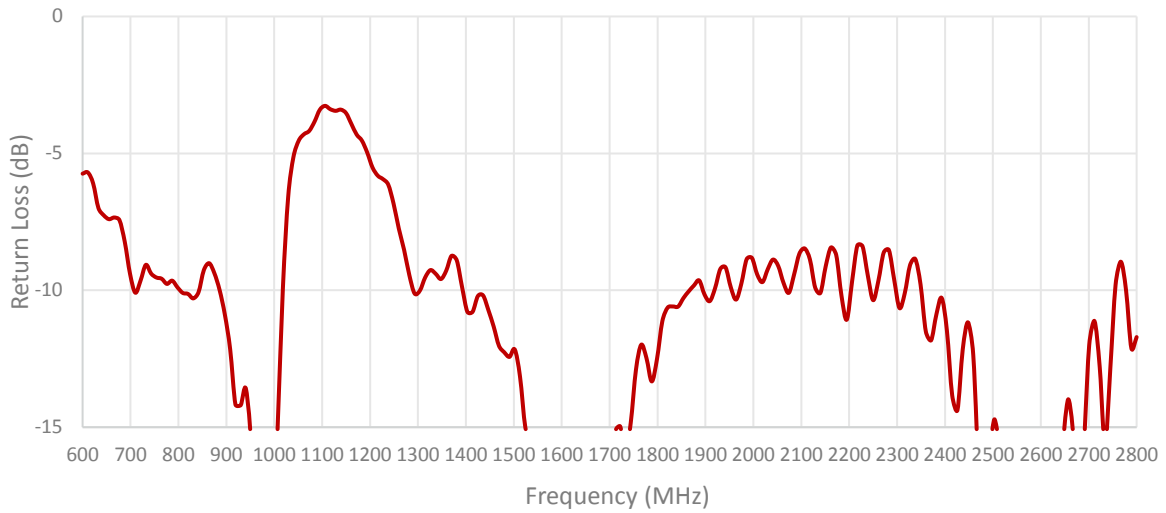

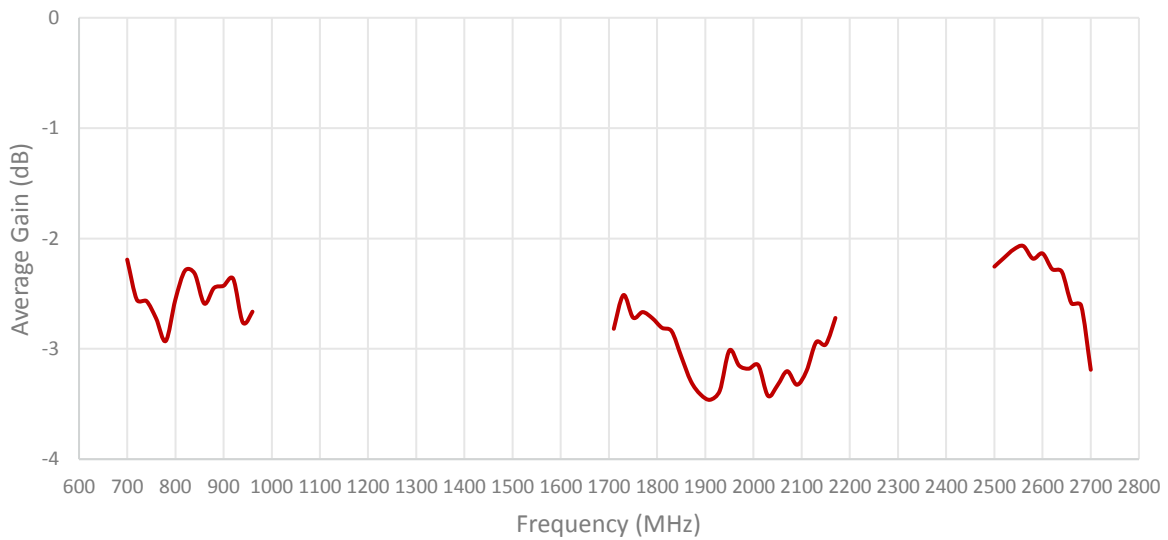
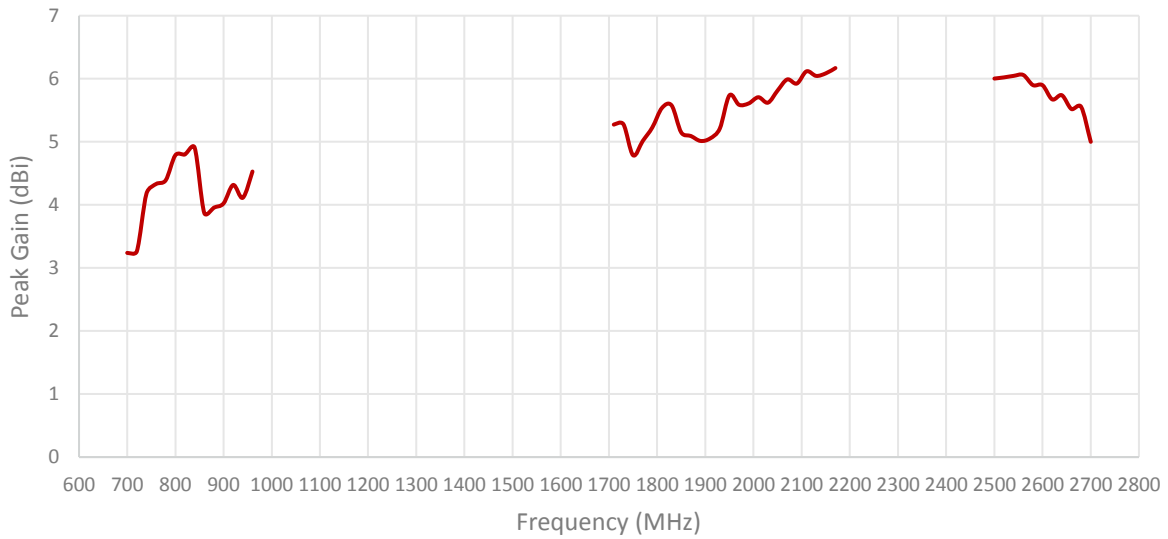
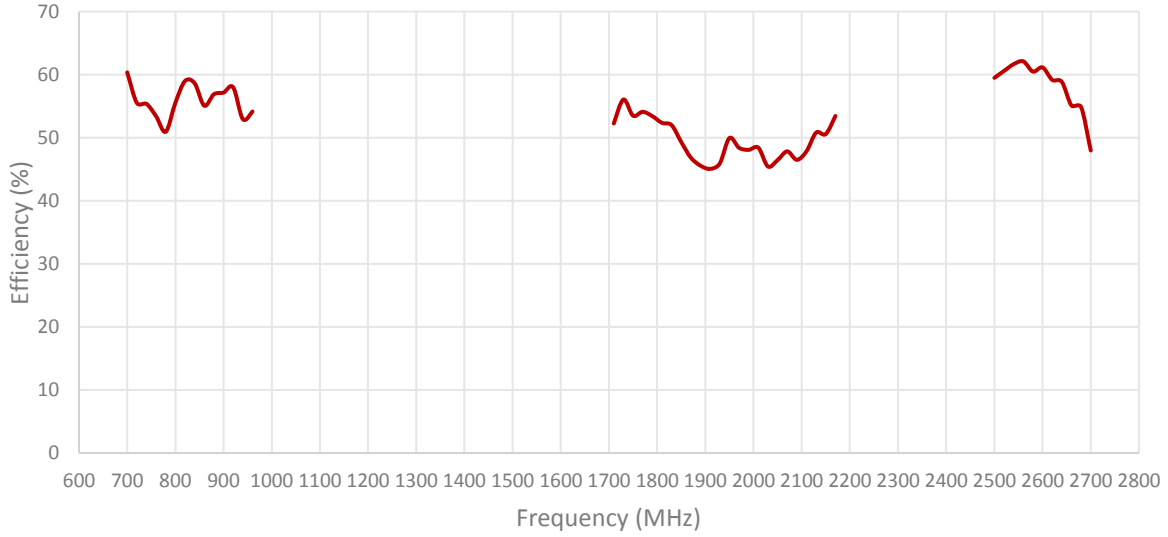

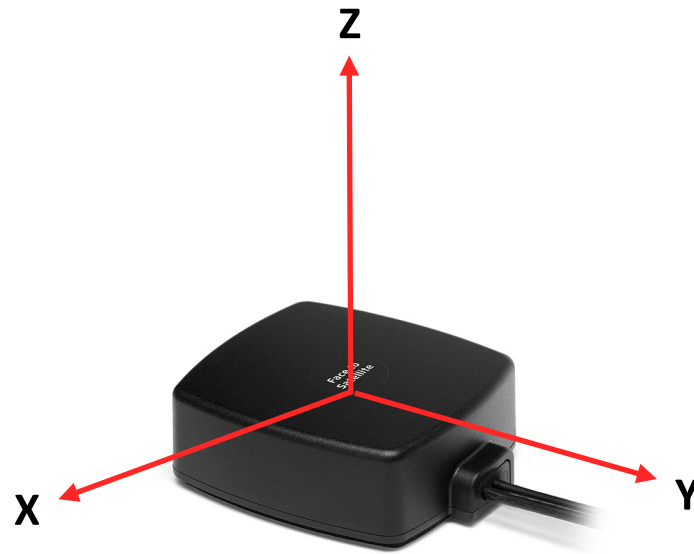

Radiation pattern reference

Cable 1: CELLULAR/LTE

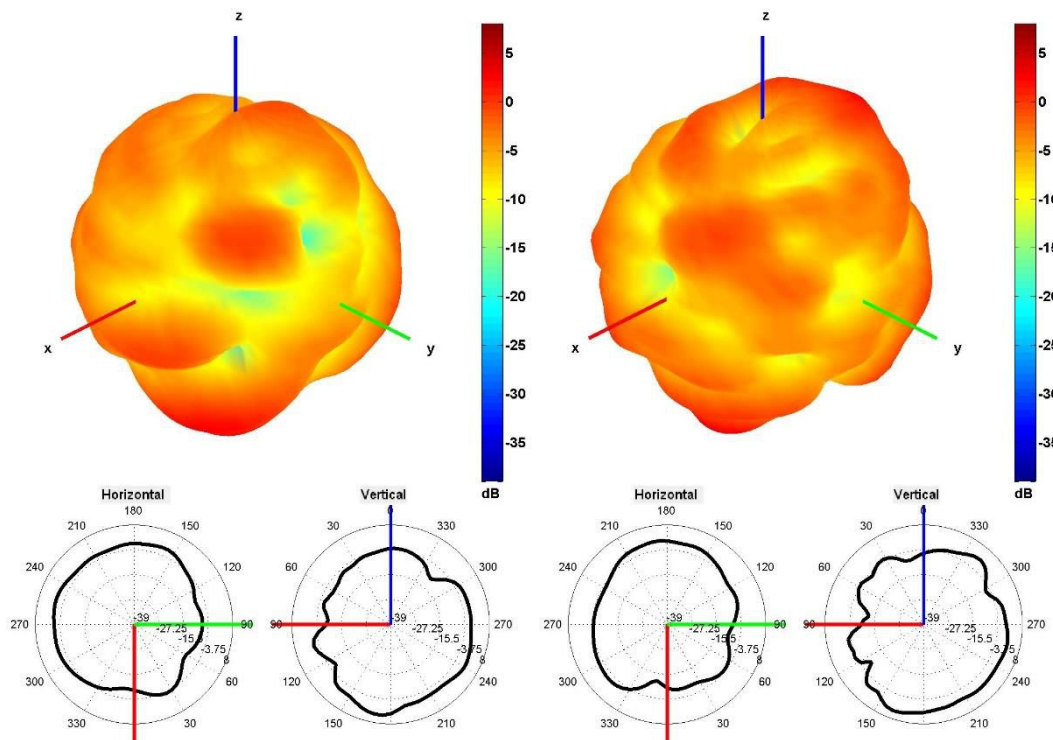

740 and 840 MHz Radiation pattern

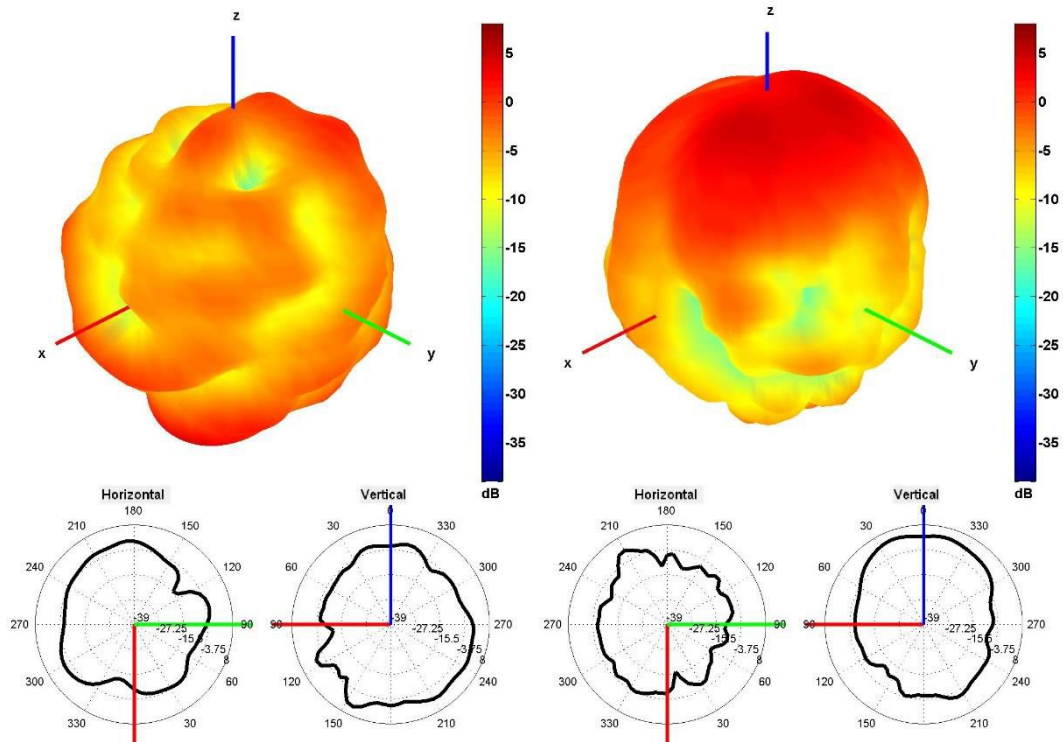

940 and 1750 MHz Radiation pattern

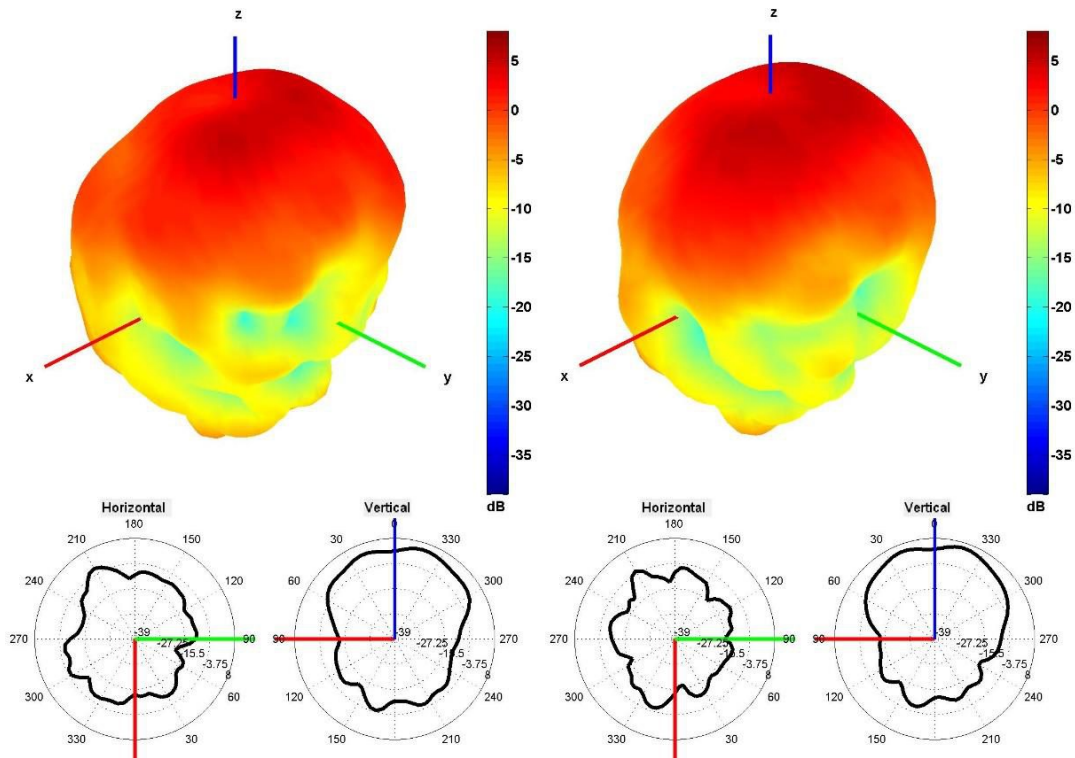

1850 and 1950 MHz Radiation pattern

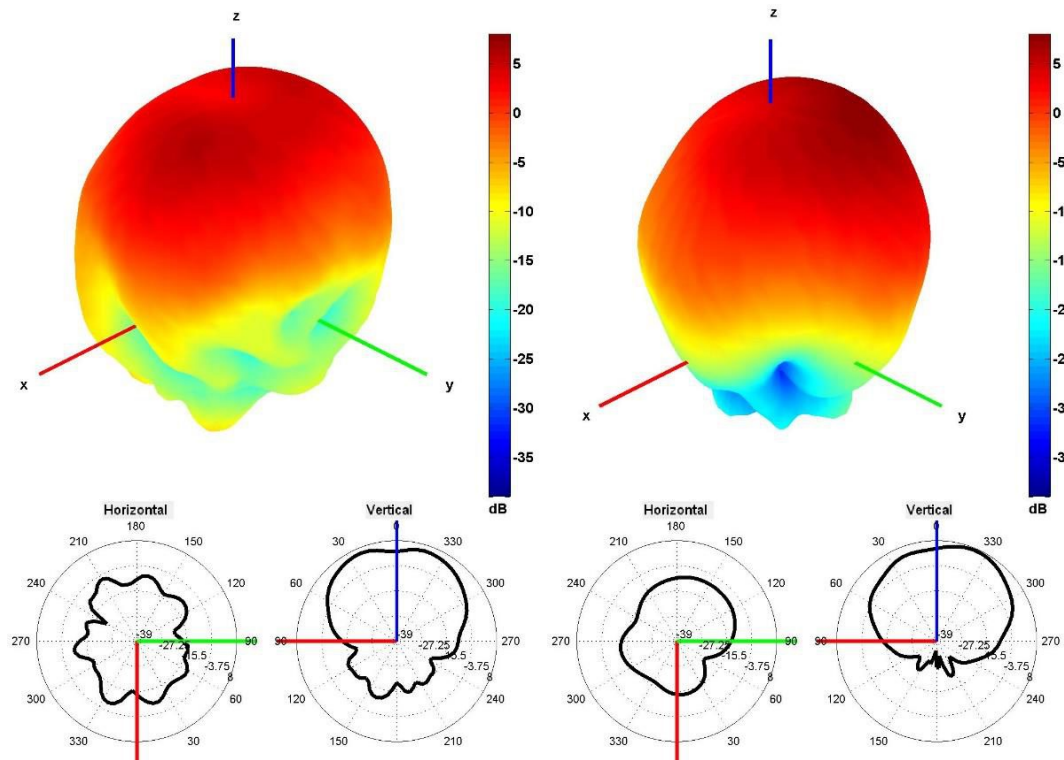

2100 and 2600 MHz Radiation pattern

4. Antenna drawings

Adhesive Mount option

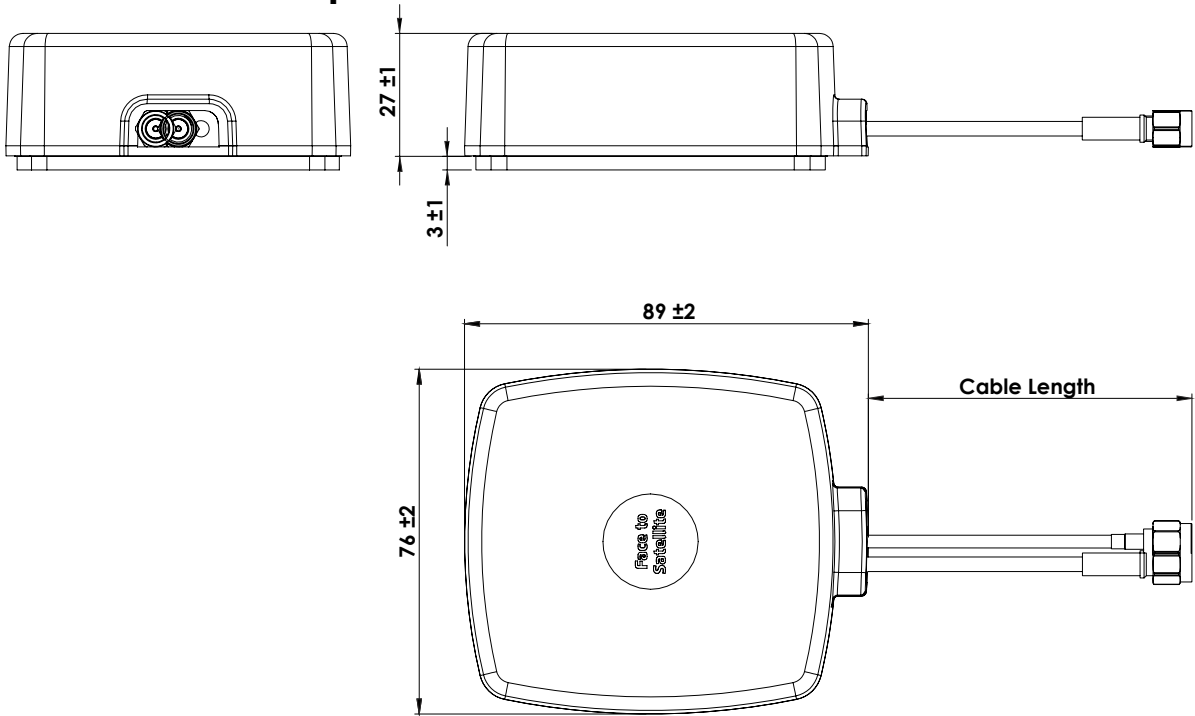

5. Antenna Images

