

2J6902Ba

2× 2.4/5.0/6.0 GHz ISM Screw Mount

Key Features

Cable 1 - 2: 2.4/5.0/6.0 GHz ISM

- 2410-2490 MHz
- 4920-5925 Mhz
- 5925-7125 MHz

Screw Mount

Anti-Rotation Mounting

High Performance

Ground Plane Independent

Customizable Cable and Connector

Dimensions 80 × 74 × 25.6 mm

Certificates: IP67, IP69



1. Antenna and electrical specifications

Cable 1

Parameters	2.4/5.0/6.0 GHz ISM Antenna		
Standards	WiFi, BT, ZigBee, ISM		
Band (MHz)	2.4 GHz	5.0 GHz	6.0 GHz
Frequency (MHz)	2410-2490	4920-5925	5925-7125
Return Loss (dB)	~-9.6	~-13.1	~-13.1
VSWR	~2.0:1	~1.6:1	~1.6:1
Efficiency (%)	~42.2	~47.2	~45.0
Peak Gain (dBi)	~-5.2	~-5.2	~-5.1
Average Gain (dB)	~-3.8	~-3.3	~-3.3
Impedance (Ohm)	50		
Polarisation	Linear		
Radiation Pattern	Omni-Directional		
Max. Input Power (W)	25		
Connector Type	SMA-Male RP Standard (Other Connectors Available)		
Cable Length	300 cm Standard (Any Cable Length Available)		
Cable Type	D302 Standard (Other Cables Available)		

Cable 2

Parameters	2.4/5.0/6.0 GHz ISM Antenna		
Standards	WiFi, BT, ZigBee, ISM		
Band (MHz)	2.4 GHz	5.0 GHz	6.0 GHz
Frequency (MHz)	2410-2490	4920-5925	5925-7125
Return Loss (dB)	~-13.6	~-14.1	~-14.4
VSWR	~1.5:1	~1.5:1	~1.5:1
Efficiency (%)	~35.2	~49.5	~49.1
Peak Gain (dBi)	~-4.9	~-5.5	~-5.4
Average Gain (dB)	~-4.5	~-3.1	~-3.1
Impedance (Ohm)	50		
Polarisation	Linear		
Radiation Pattern	Omni-Directional		
Max. Input Power (W)	25		
Connector Type	SMA-Male RP Standard (Other Connectors Available)		
Cable Length	300 cm Standard (Any Cable Length Available)		
Cable Type	D302 Standard (Other Cables Available)		

Antenna Measurement Conditions:

Mounted on Metal Plate of 30 x 30 cm

100 cm of Cable D302

Measured in Certified CTIA 3D Anechoic Chamber

2. Mechanical and environmental specifications

Specifications	2J6902Ba
Mounting Type	Screw Mount
Dimensions (mm)	80 x 74 x 25.6
Max. Tighten Torque (Nm)	5 Nm
Radome Type	ASA UV Stable
Radome Color	Black, White
Operating Temperature (C)	-40 to +85
Storage Temperature (C)	-40 to +85
Substance Compliance	RoHS
Certificates	IP67, IP69

3. Antenna parameters

Cable 1: 2.4/5.0/6.0 GHz ISM

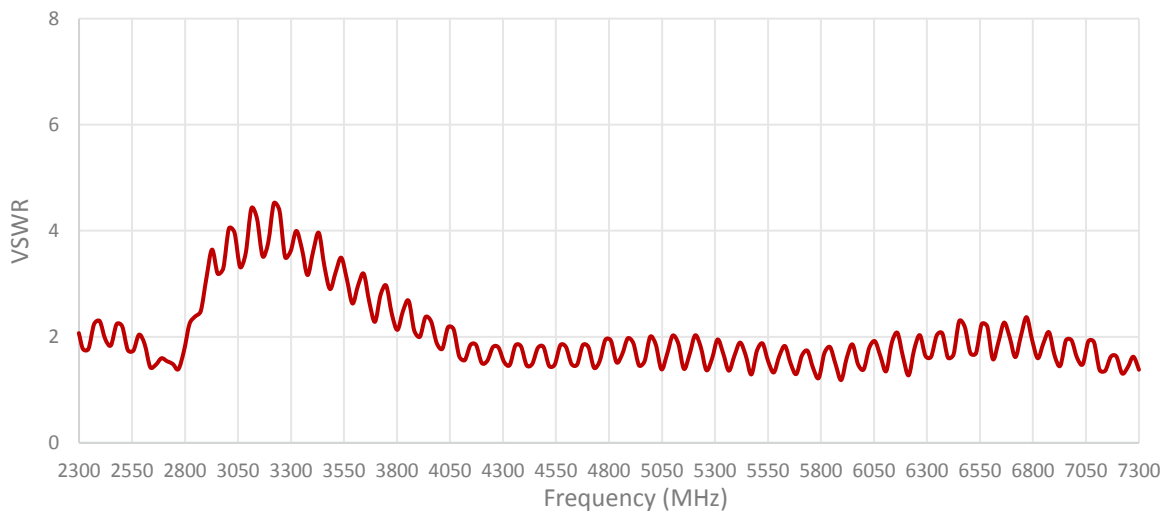
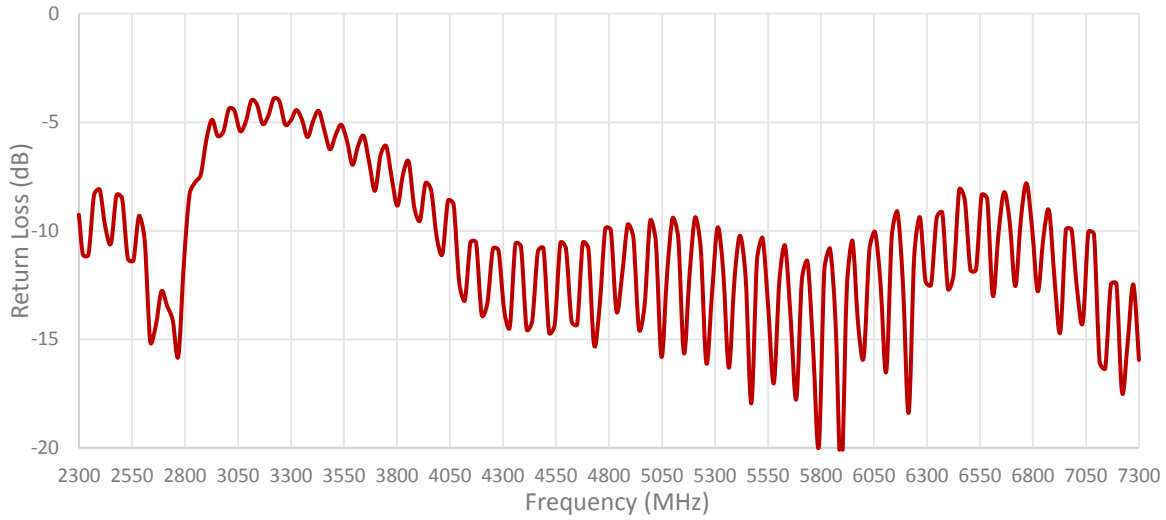

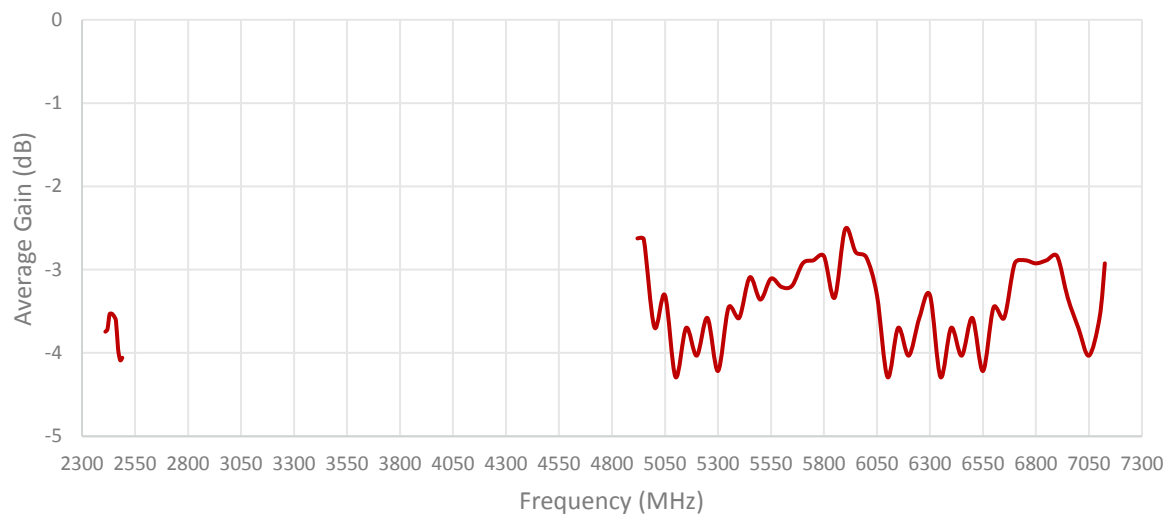
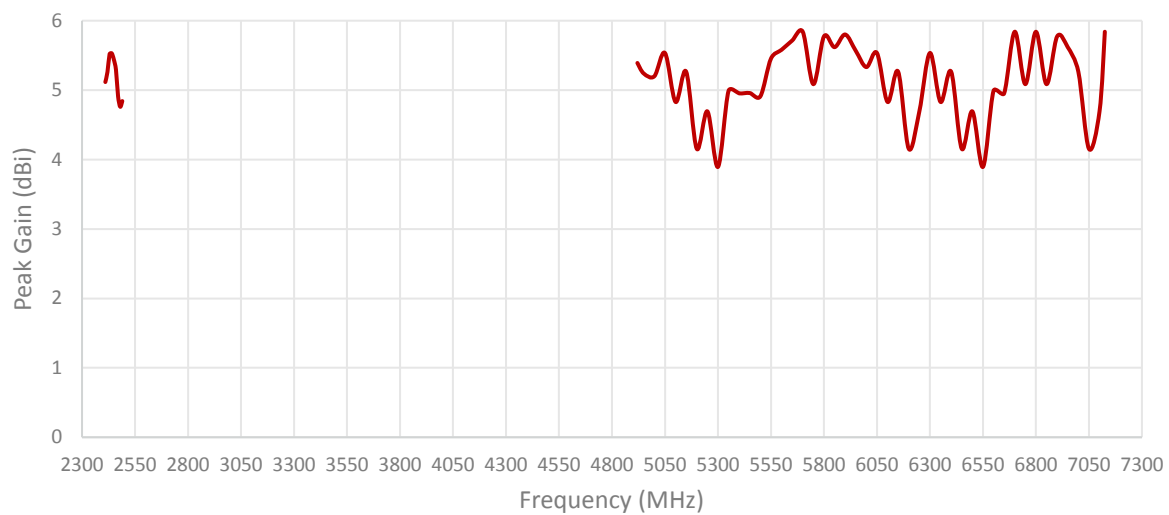
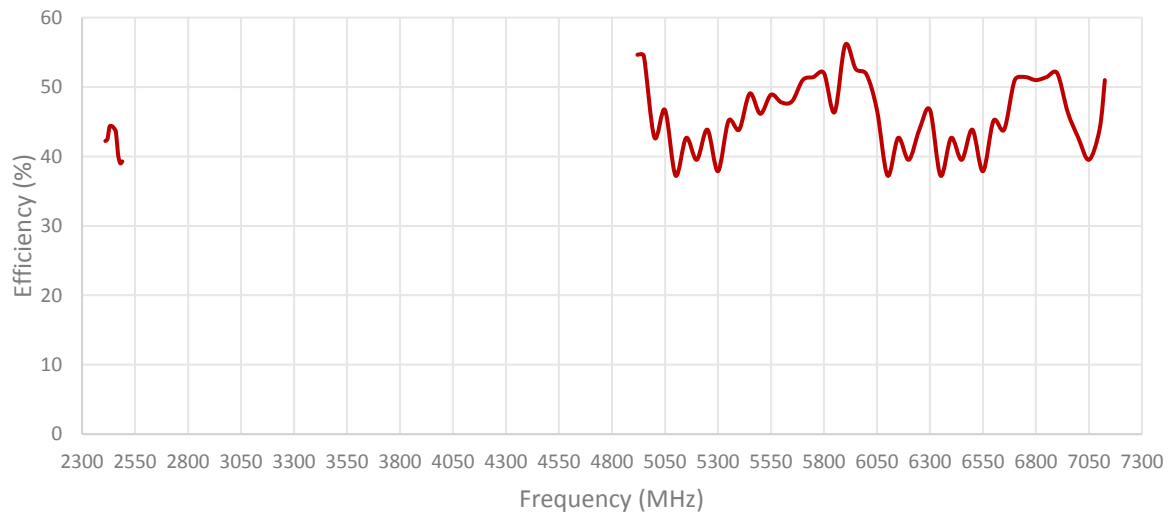

Cable 2: 2.4/5.0/6.0 GHz ISM

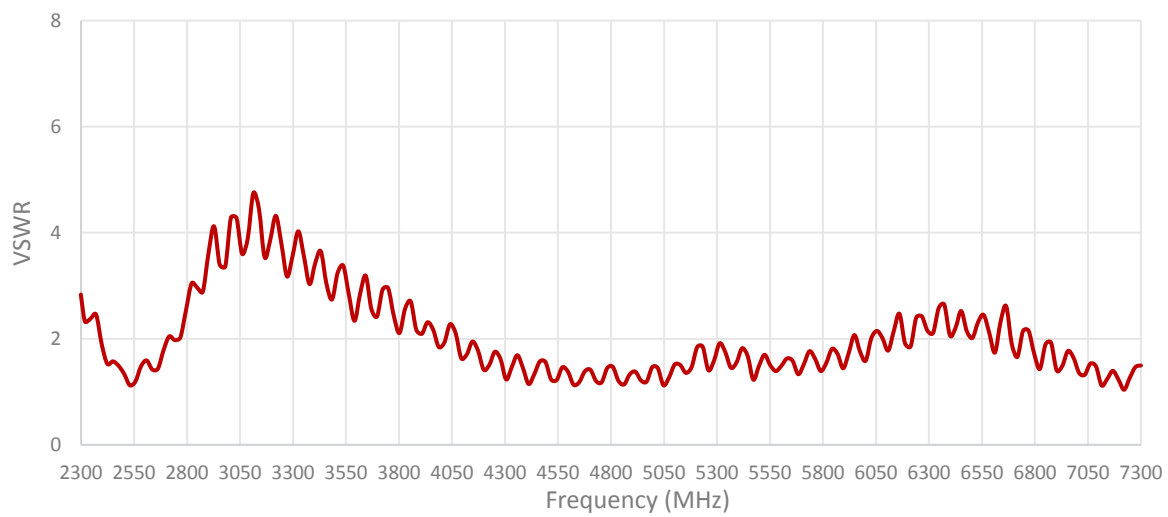
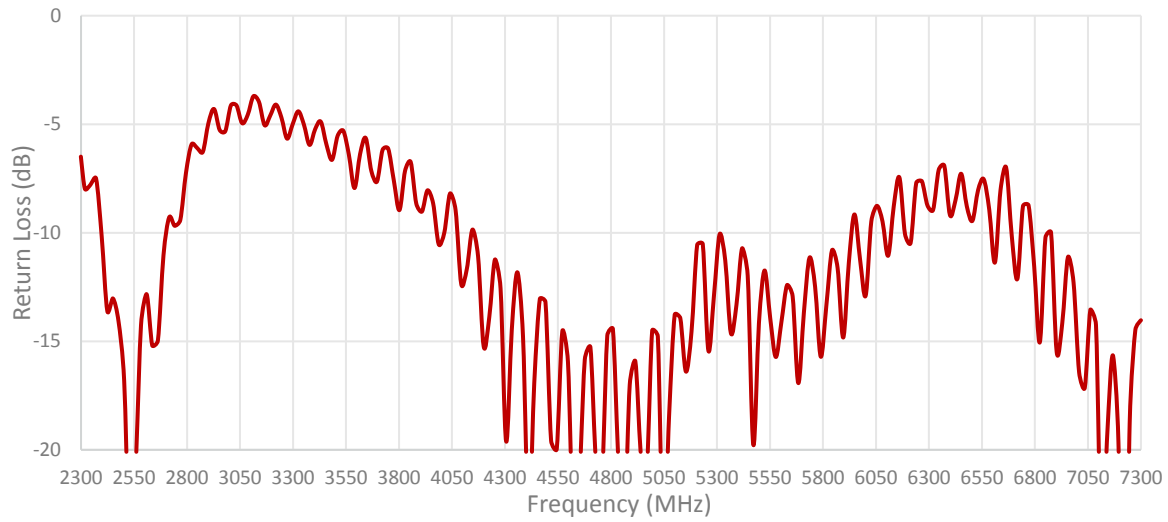

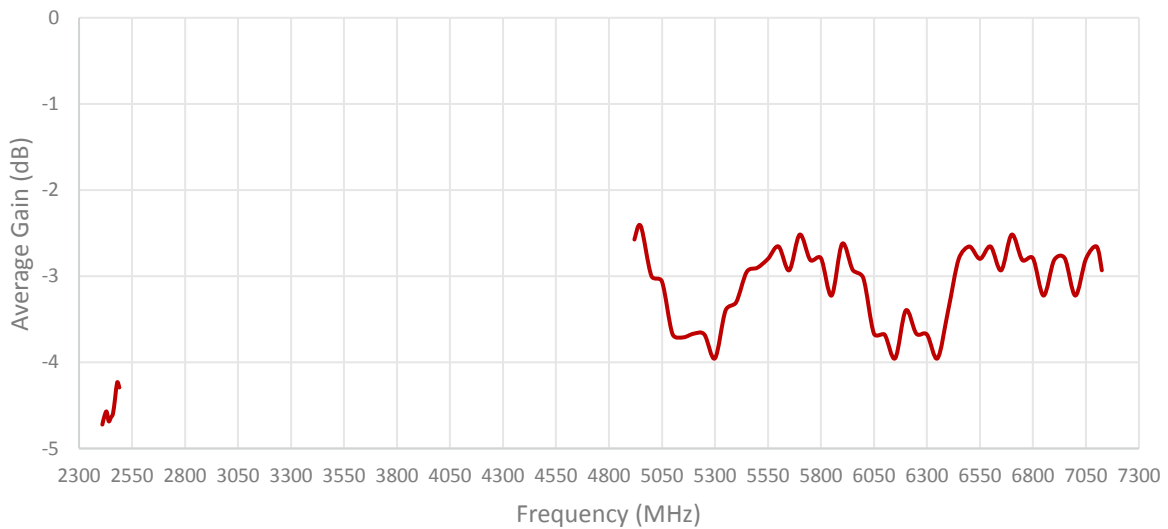
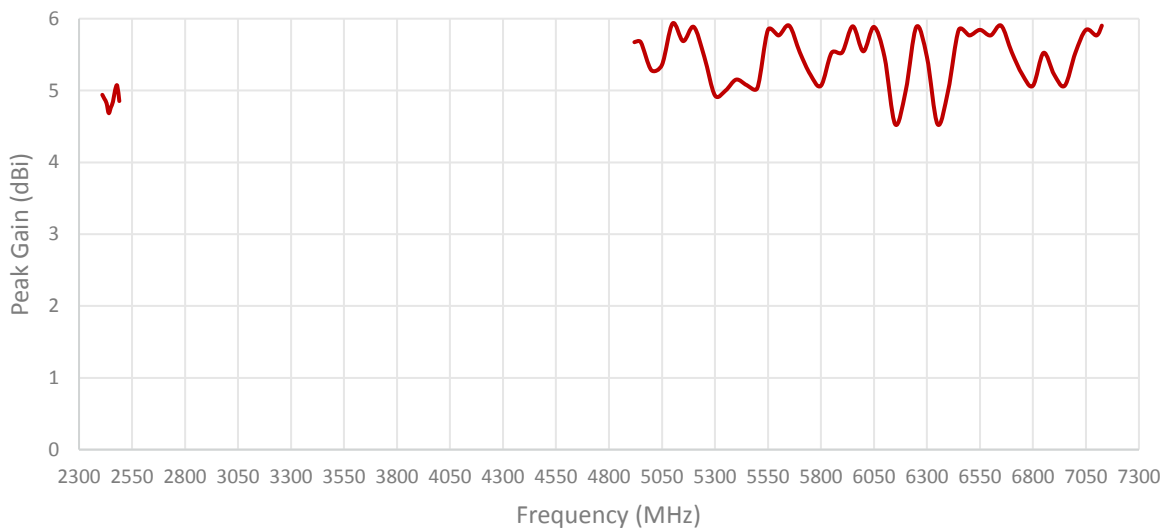
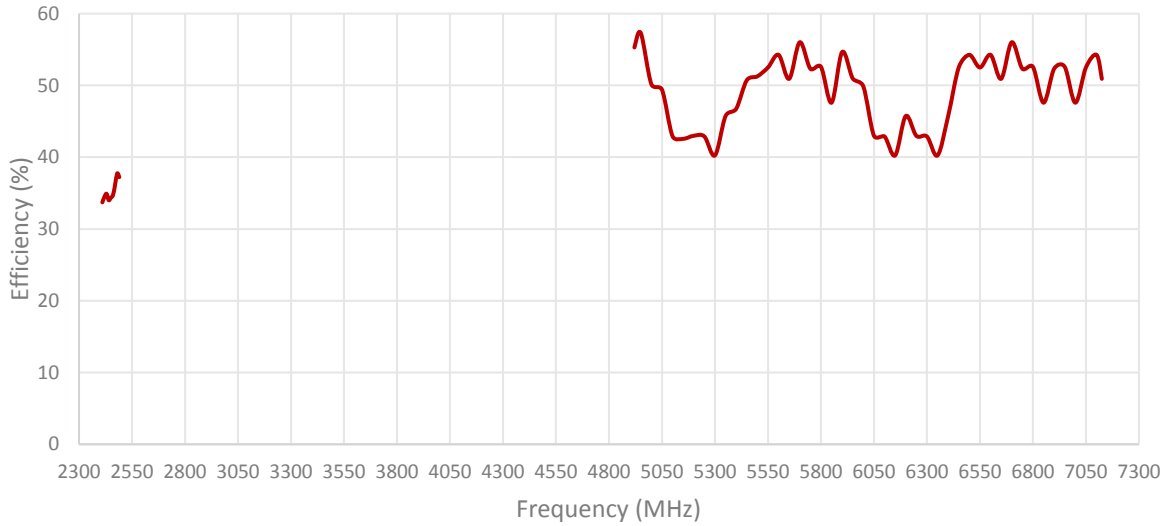

ISOLATION FOR CABLES 1 AND 2

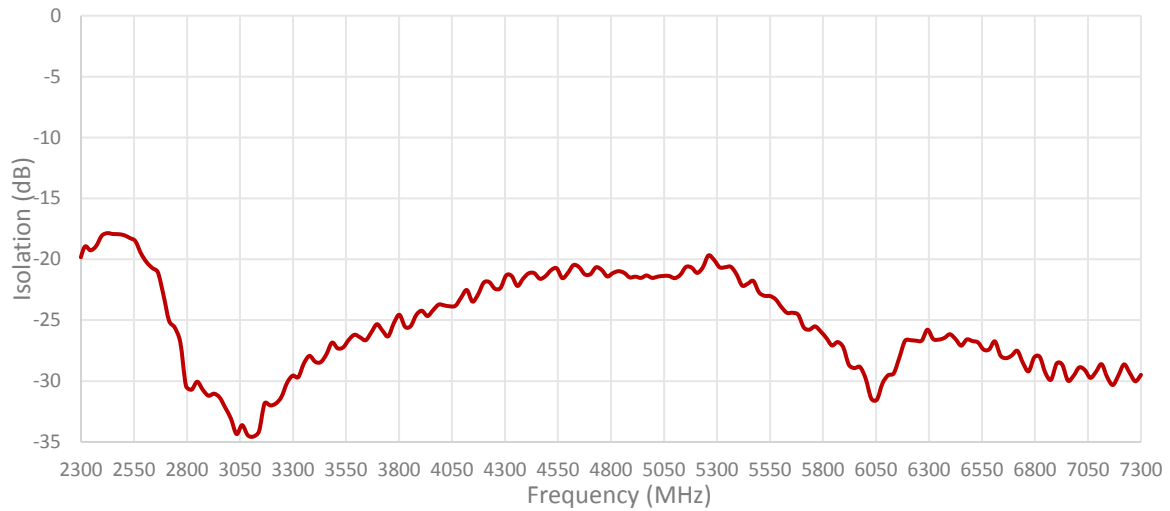

ENVELOPE CORRELATION COEFFICIENT FOR CABLES 1 AND 2

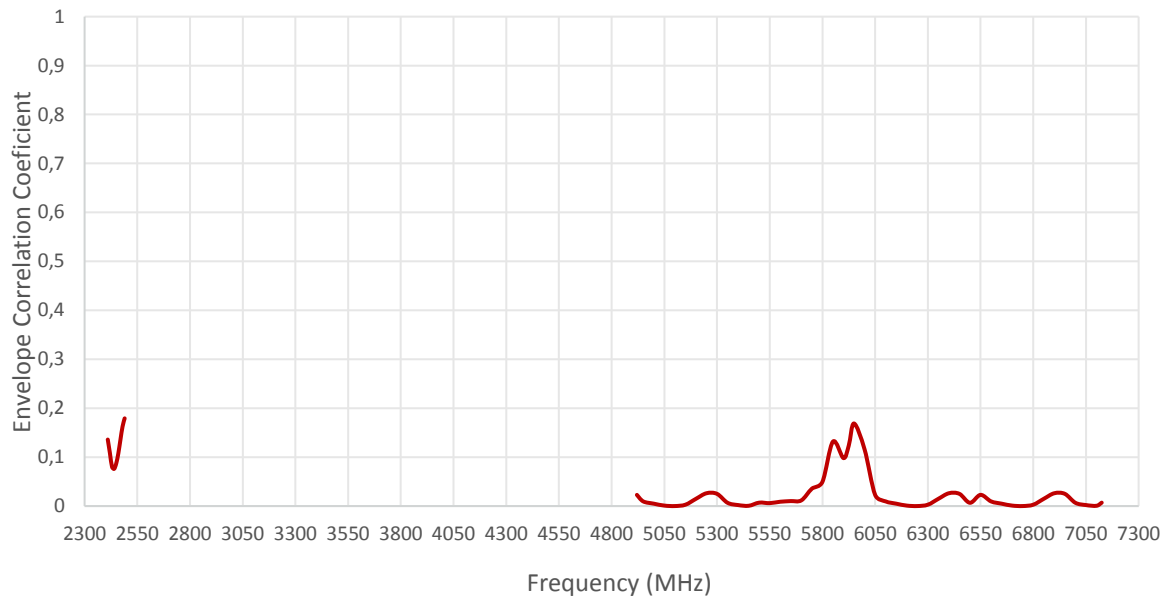

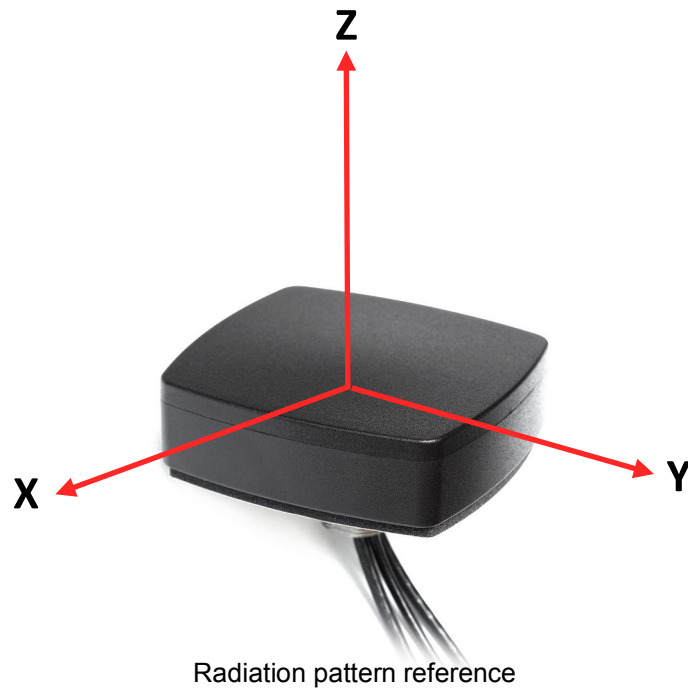

Cable 1: 2.4/5.0/6.0 GHz ISM

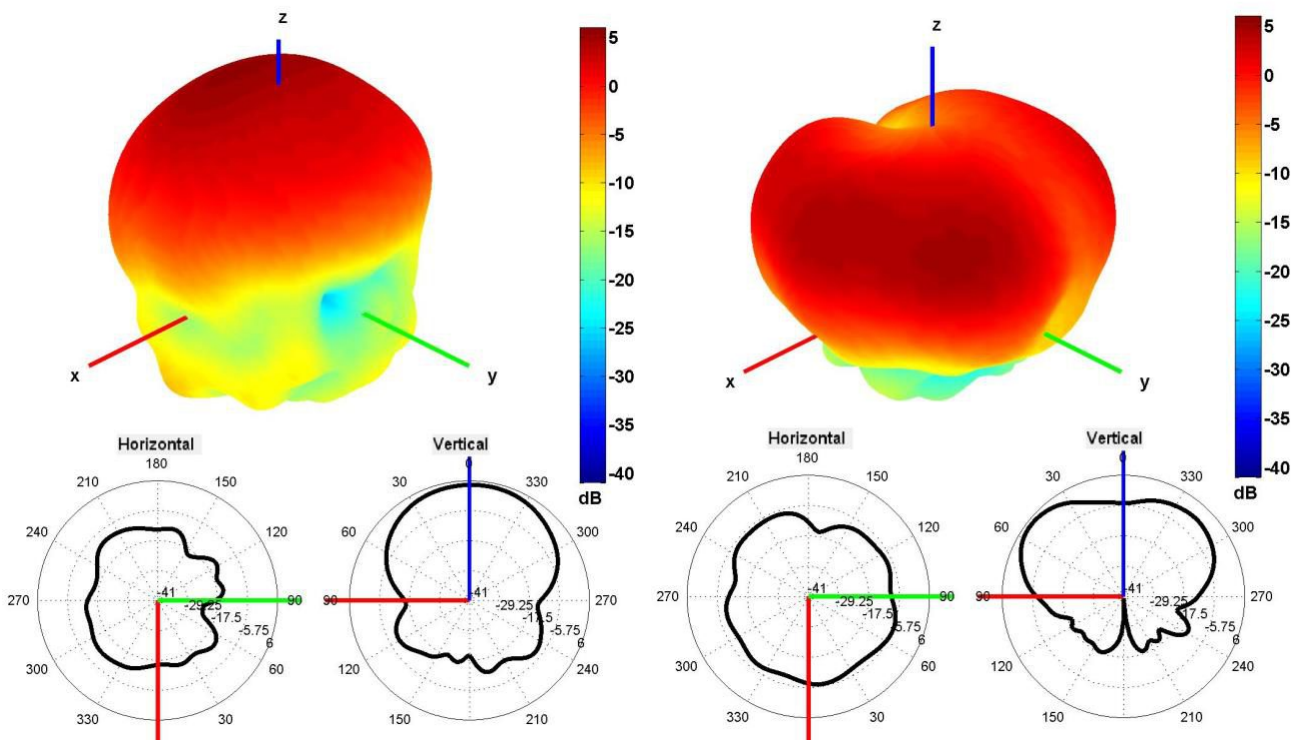

2450 and 5500 MHz Radiation pattern

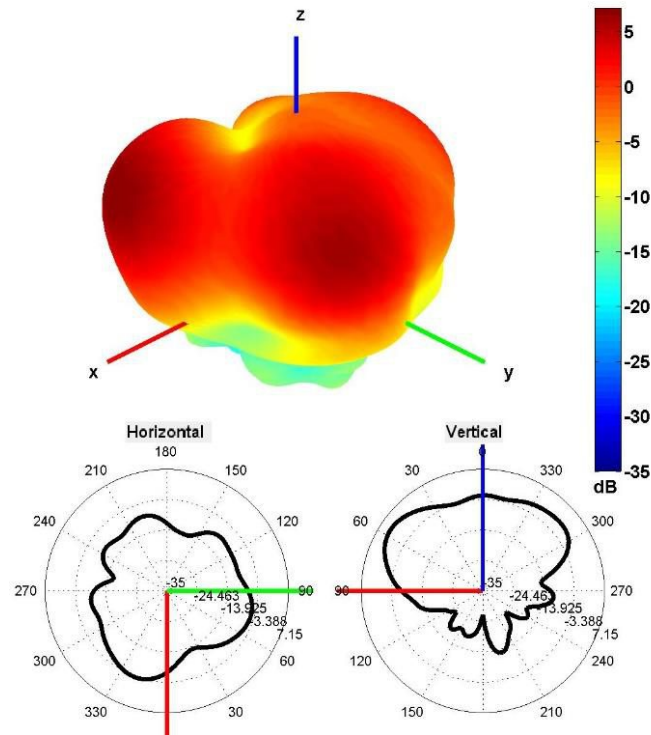

Cable 2: 2.4/5.0/6.0 GHz ISM

6500 MHz Radiation pattern

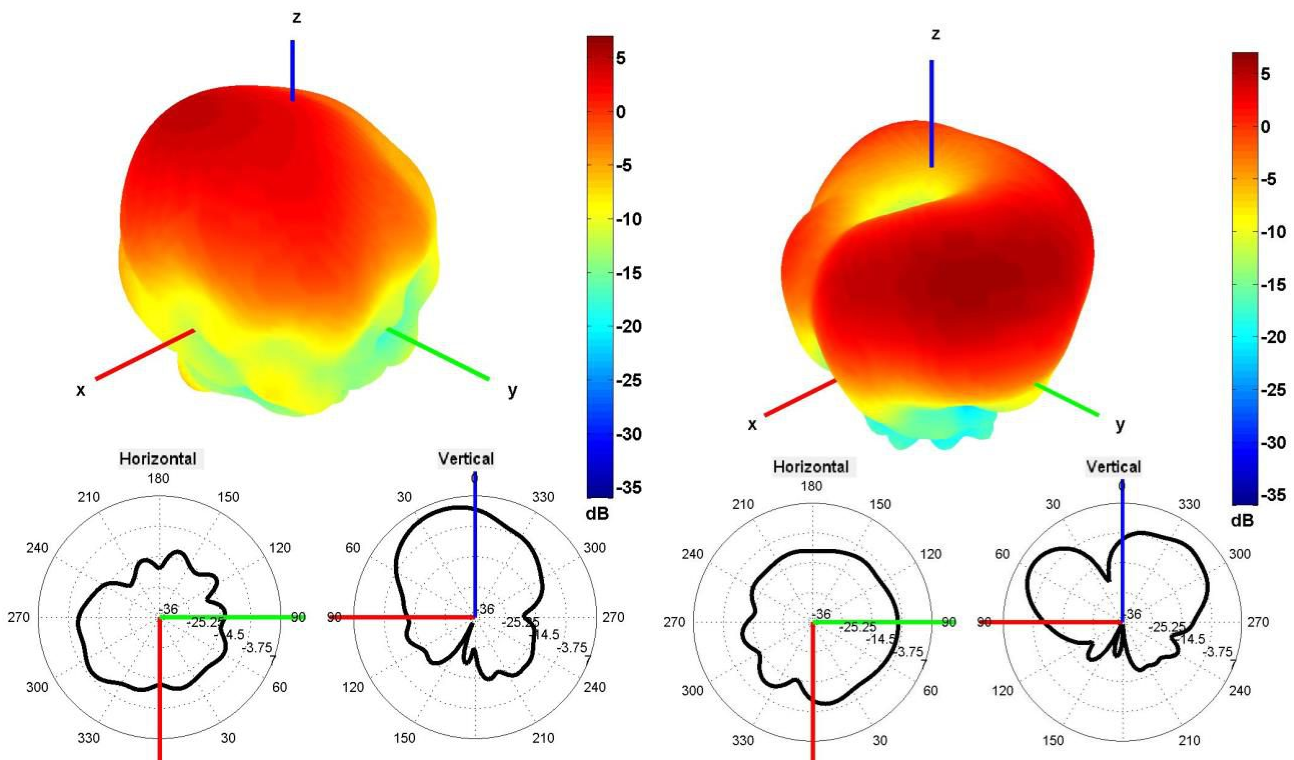

2450 and 5500 MHz Radiation pattern

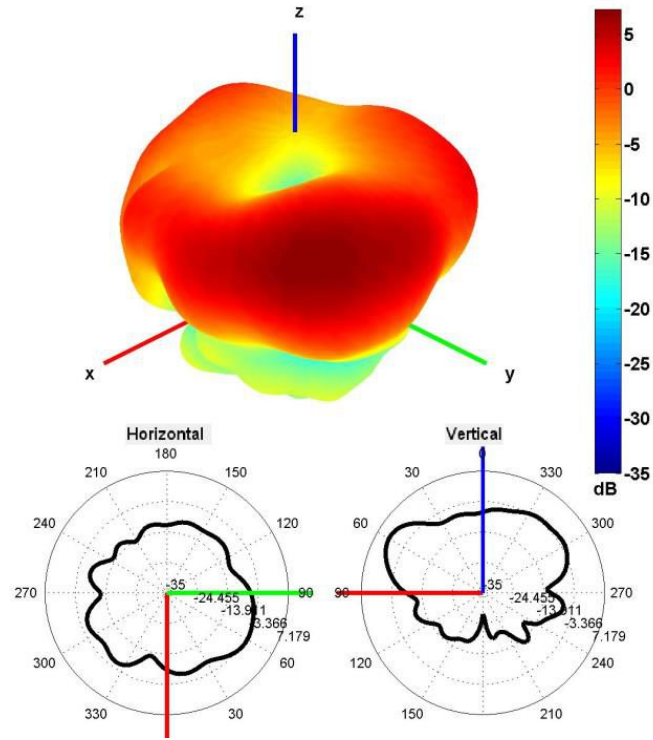

6500 MHz Radiation pattern

4. Antenna drawings

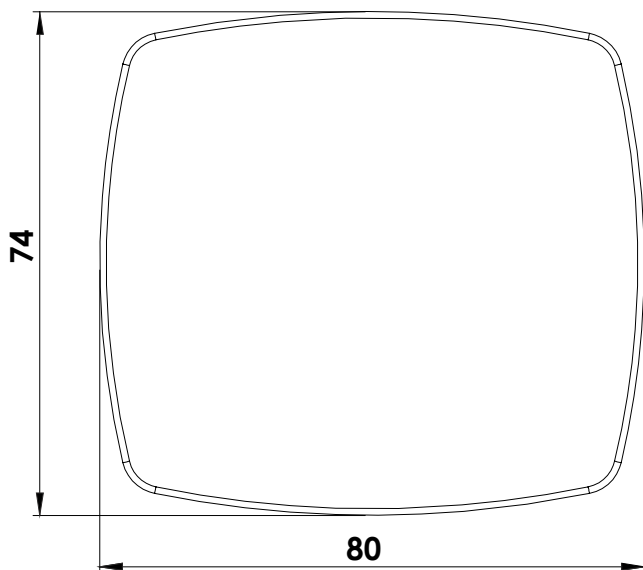
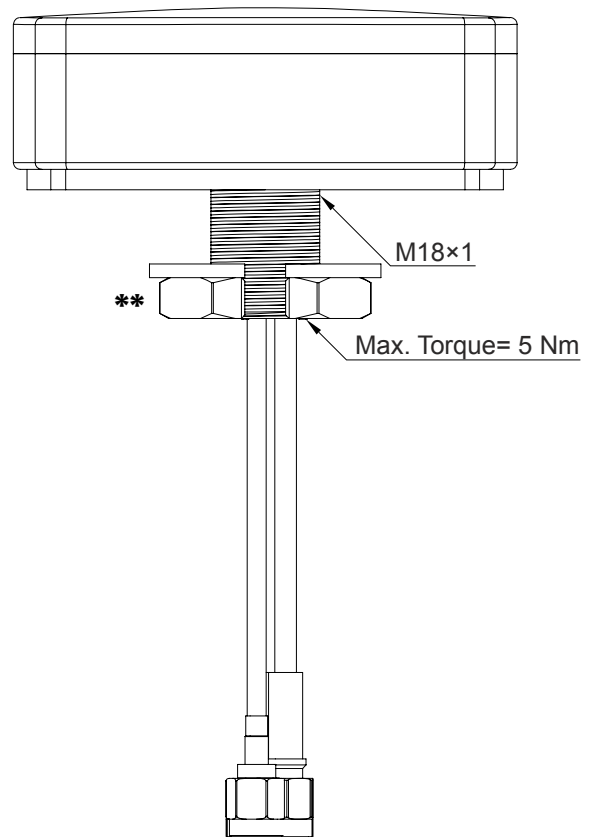
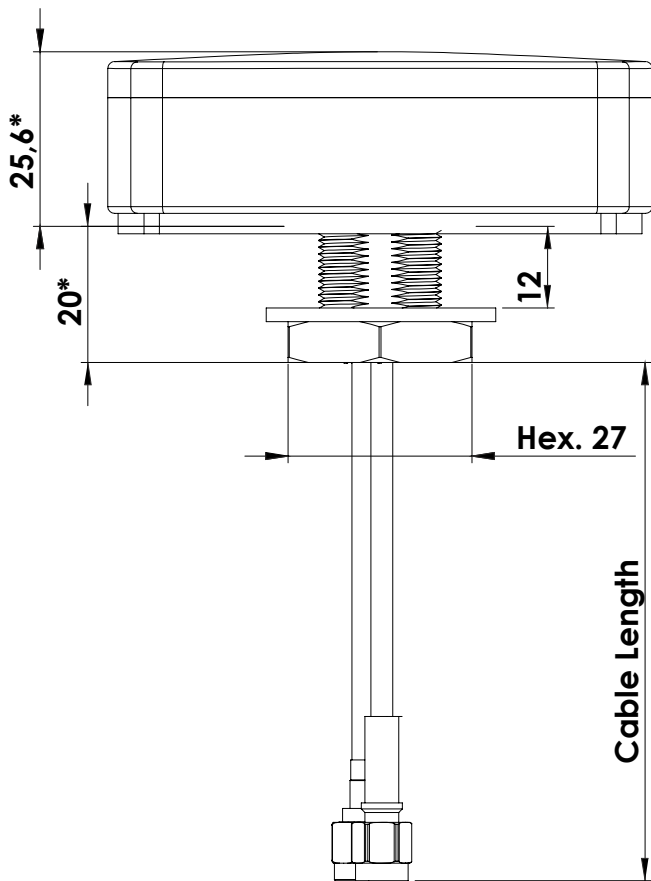

Mounting hole

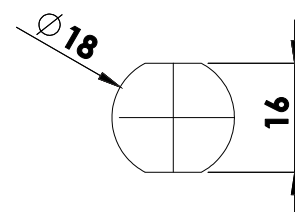

Max. mounting thickness 12mm
 Note: Dimensions are in millimeters
 *Dimensions are after mounting
 **Max. Torque= 5 Nm

5. Antenna Images

