

## 2J5215P-868

868 MHz ISM Adhesive Mount

### Key Features

- 868 MHz ISM
- 863-870 MHz
- Adhesive Mount
- Flexible Housing
- Compact Size
- High Performance
- Customizable Cable and Connector
- Dimensions 117.4 x 12.5 x 6.5 mm



## 1. Antenna and electrical specifications

Parameters	868 MHz ISM Antenna
<b>Standards</b>	ZigBee, ISM, SigFox, LoRa
<b>Band (MHz)</b>	868 MHz
<b>Frequency (MHz)</b>	863-870
<b>Return Loss (dB)</b>	~-20.3
<b>VSWR</b>	~1.2:1
<b>Efficiency (%)</b>	~59.1
<b>Peak Gain (dBi)</b>	~2.6
<b>Average Gain (dB)</b>	~-2.3
<b>Impedance (Ohm)</b>	50
<b>Polarisation</b>	Linear
<b>Radiation Pattern</b>	Omni-Directional
<b>Max. Input Power (W)</b>	25
<b>Connector Type</b>	SMA-Male Standard (Other Connectors Available)
<b>Cable Length</b>	300 cm Standard (Any Cable Length Available)
<b>Cable Type</b>	RG174 Standard (Other Cables Available)

### Antenna Measurement Conditions:

Mounted on 30 x 30 x 0.25 cm ABS Plate

200 cm RG174 Cable

Measured in Certified CTIA 3D Anechoic Chamber

## 2. Mechanical and environmental specifications

Specifications	2J5215P-868
<b>Mounting Type</b>	Adhesive Mount
<b>Dimensions (mm)</b>	117.4 x 12.5 x 6.5
<b>Radome</b>	TPE
<b>Radome color</b>	Black, White
<b>Operating Temperature (C)</b>	-40 to +85
<b>Storage Temperature (C)</b>	-40 to +85
<b>Substance Compliance</b>	RoHS

### 3. Antenna parameters

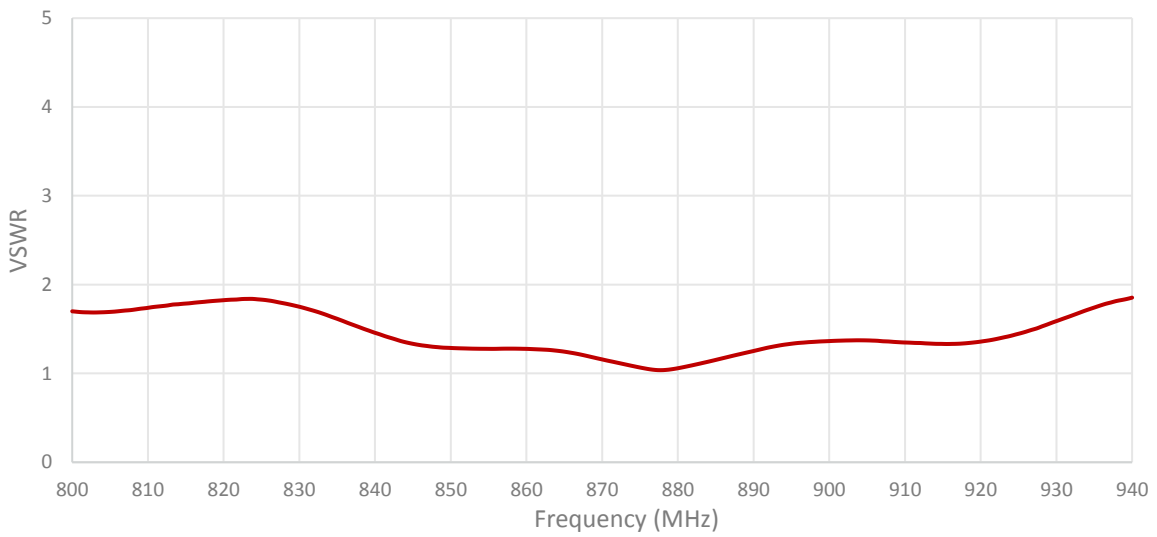
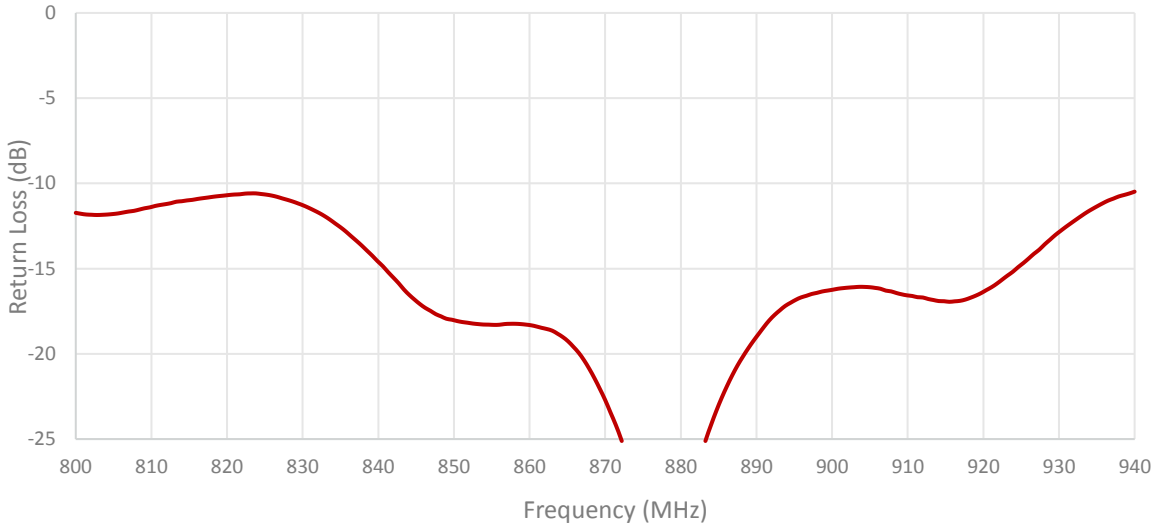

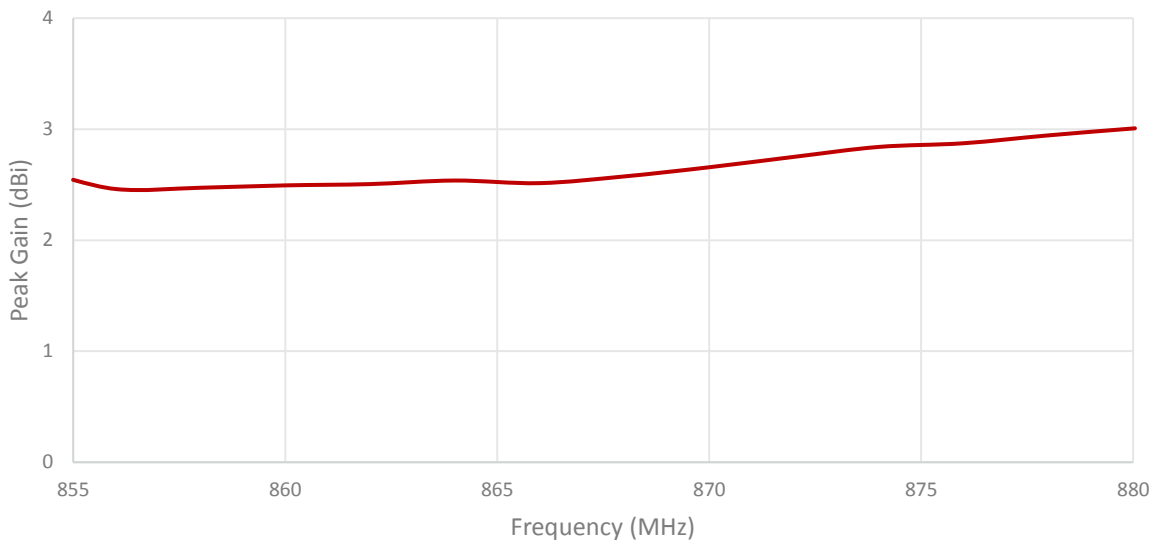
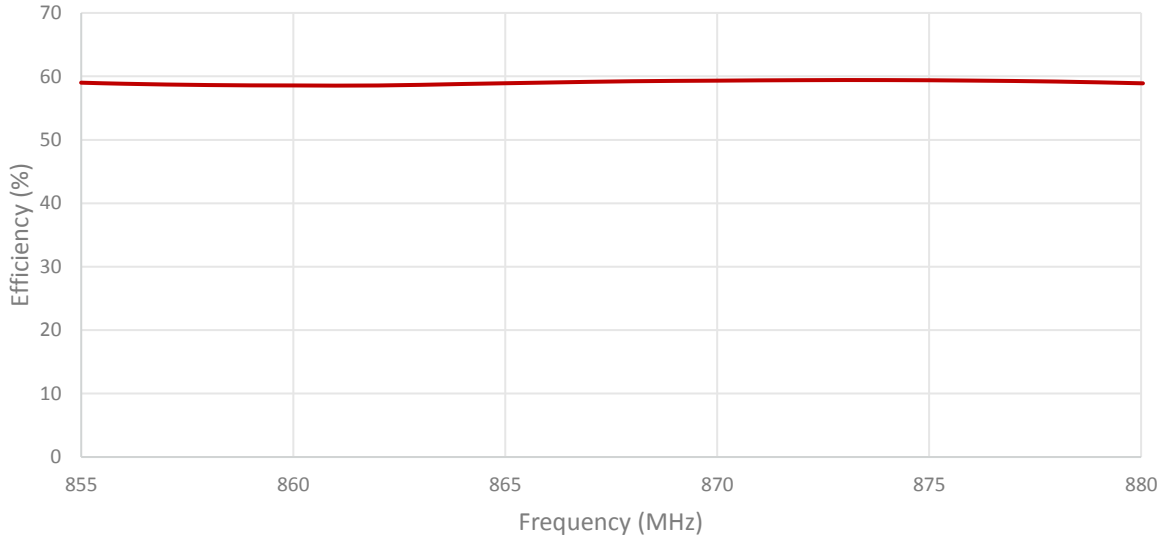

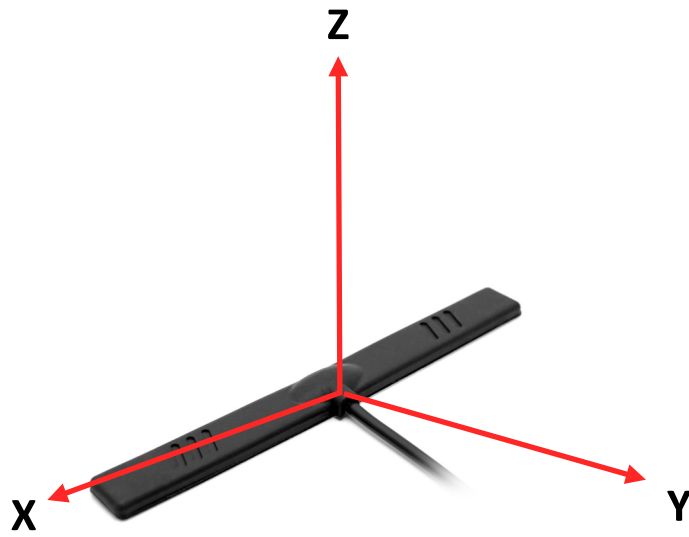
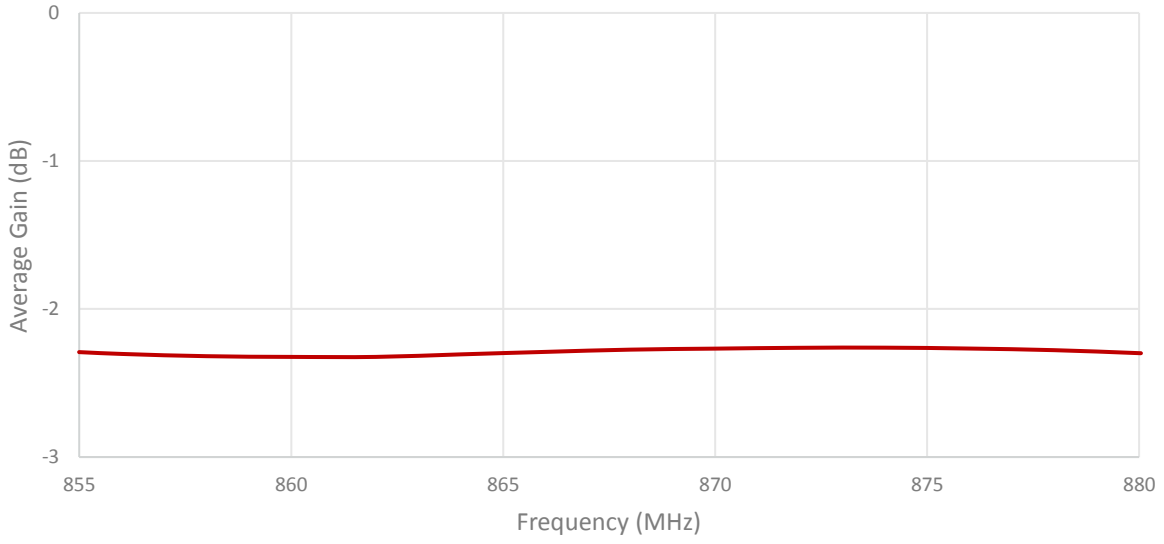

Radiation pattern reference

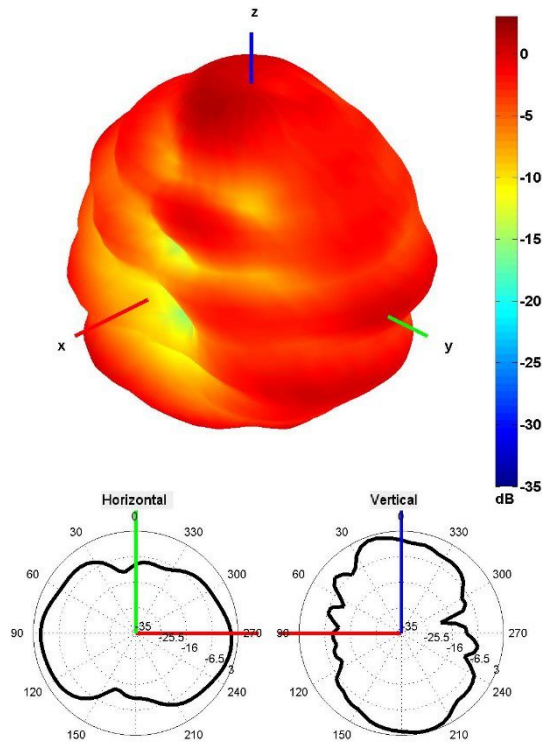

868 MHz Radiation pattern

#### 4. Antenna drawings

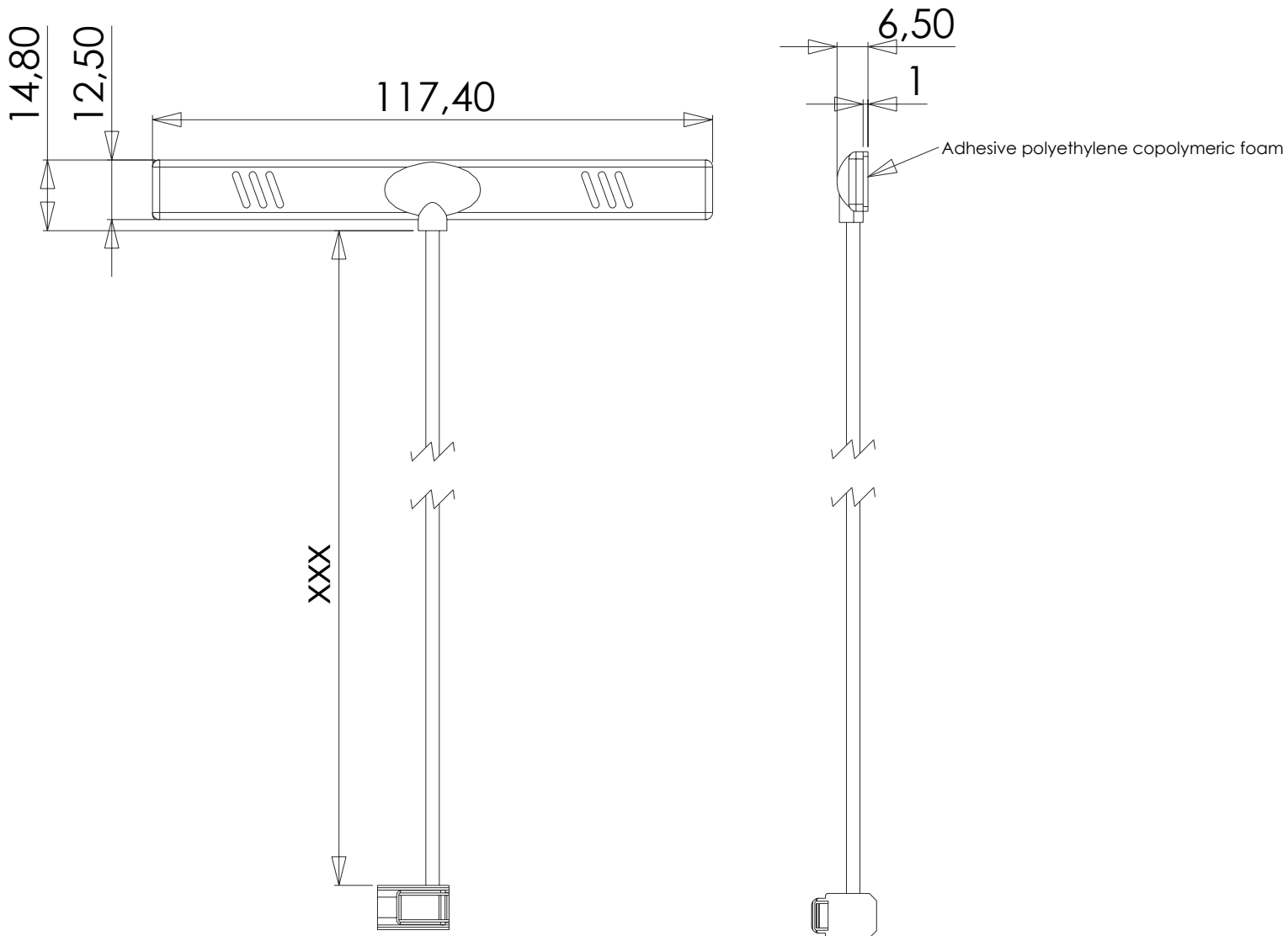

## 5. Antenna Images

