

2J5115P-868

868 MHz ISM Adhesive Mount

Key Features

868 MHz ISM
- 863-870 MHz
Adhesive Mount
Flexible Housing
Compact Size
High Performance
Customizable Cable and Connector
Dimensions 122 x 14 x 6 mm



1. Antenna and electrical specifications

Parameters	868 MHz ISM Antenna
Standards	ZigBee, ISM, SigFox, LoRa
Band (MHz)	868 MHz
Frequency (MHz)	863-870
Return Loss (dB)	~-23.4
VSWR	~1.2:1
Efficiency (%)	~56.9
Peak Gain (dBi)	~2.5
Average Gain (dB)	~-2.4
Impedance (Ohm)	50
Polarisation	Linear
Radiation Pattern	Omni-Directional
Max. Input Power (W)	25
Connector Type	SMA-Male Standard (Other Connectors Available)
Cable Length	300 cm Standard (Any Cable Length Available)
Cable Type	RG174 Standard (Other Cables Available)

Antenna Measurement Conditions:

Mounted on 30 x 30 x 0.25 cm ABS Plate

200 cm RG174 Cable

Measured in Certified CTIA 3D Anechoic Chamber

2. Mechanical and environmental specifications

Specifications	2J5115P-868
Mounting Type	Adhesive Mount
Dimensions (mm)	122 x 14 x 6
Radome	TPE
Radome color	Black, White
Operating Temperature (C)	-40 to +85
Storage Temperature (C)	-40 to +85
Substance Compliance	RoHS

3. Antenna parameters

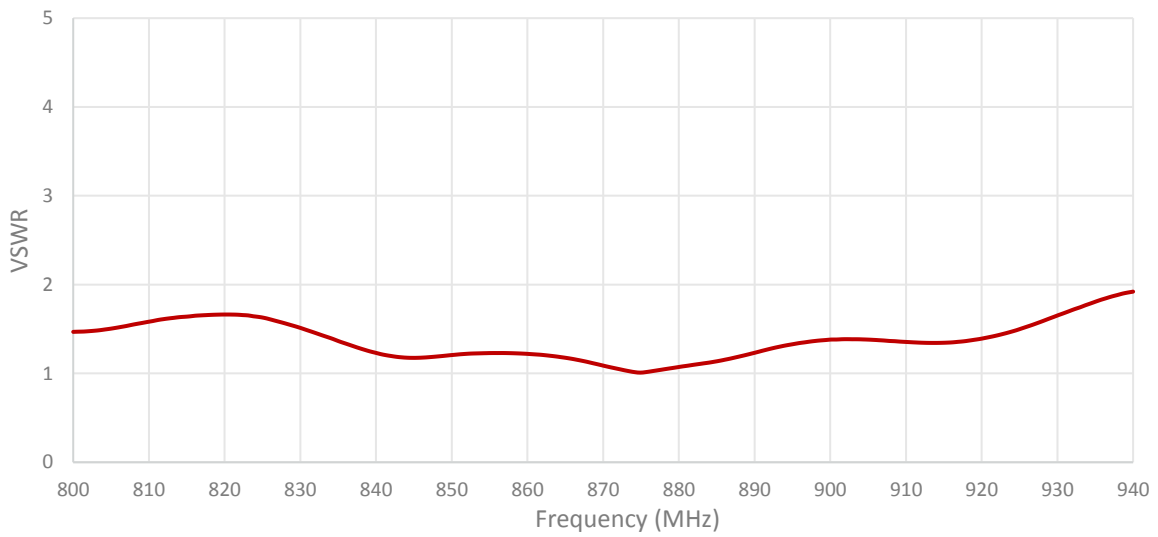
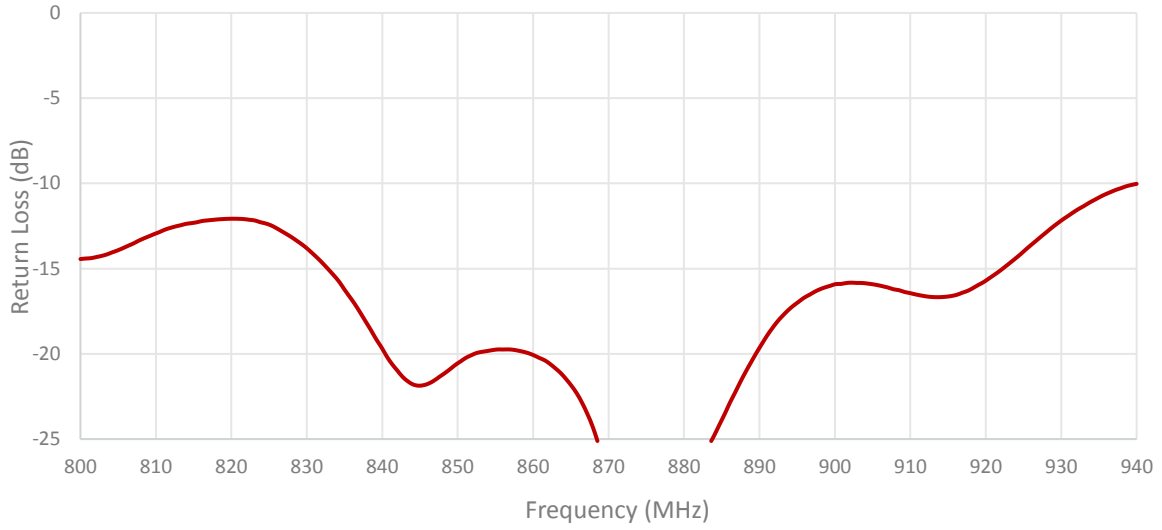

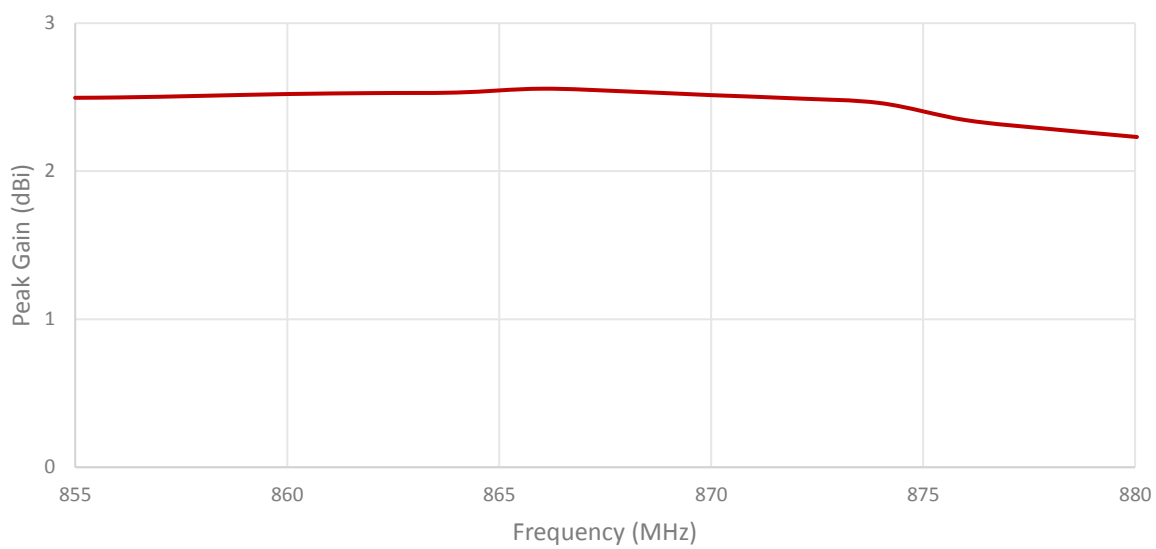
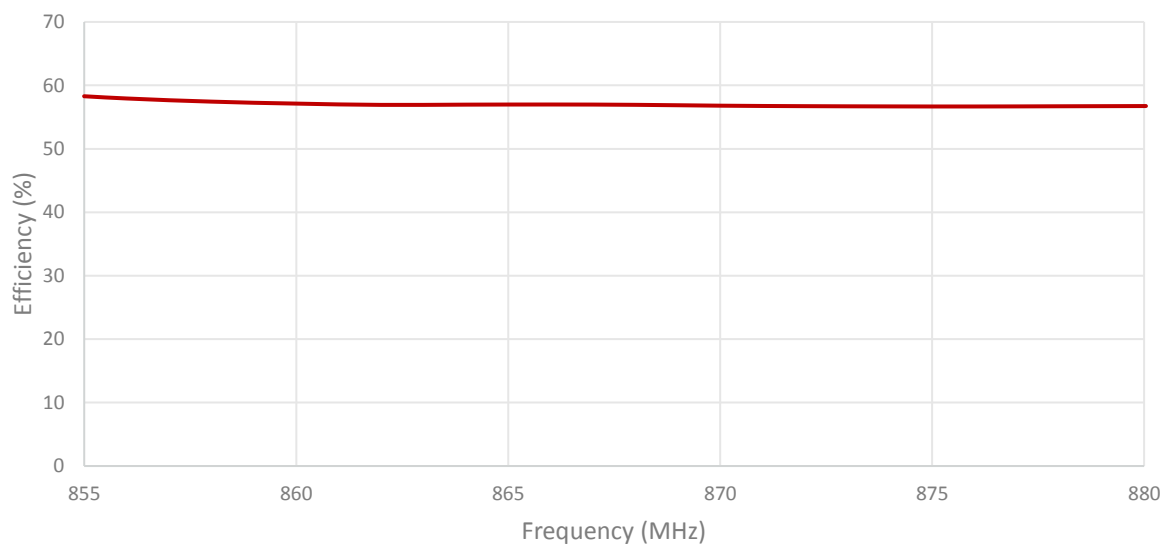

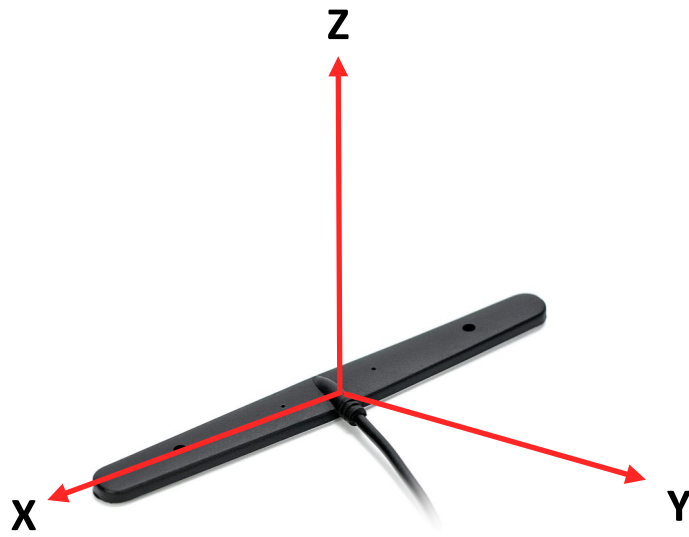
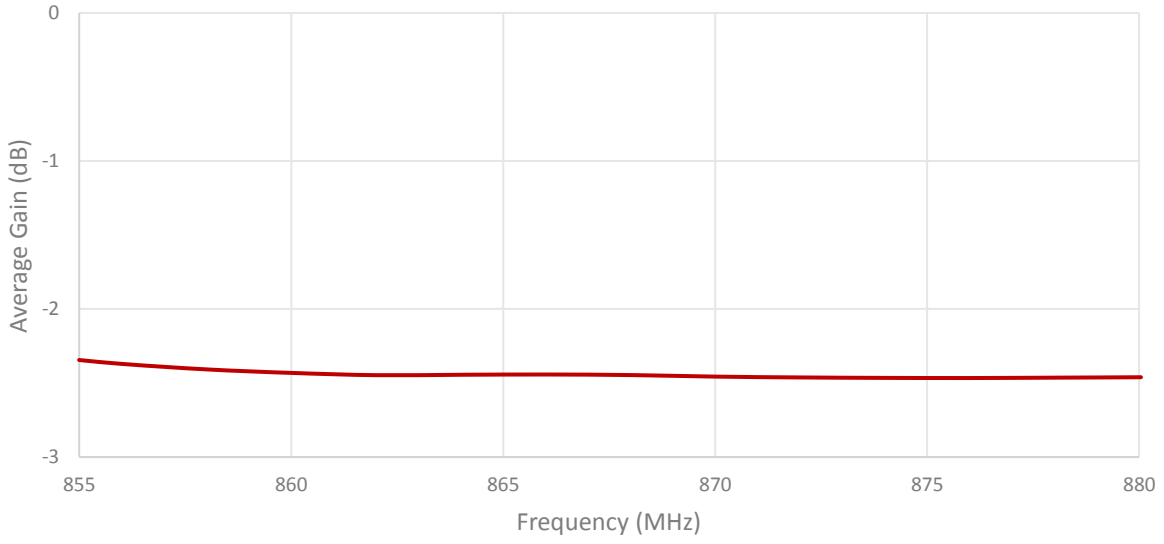

Radiation pattern reference

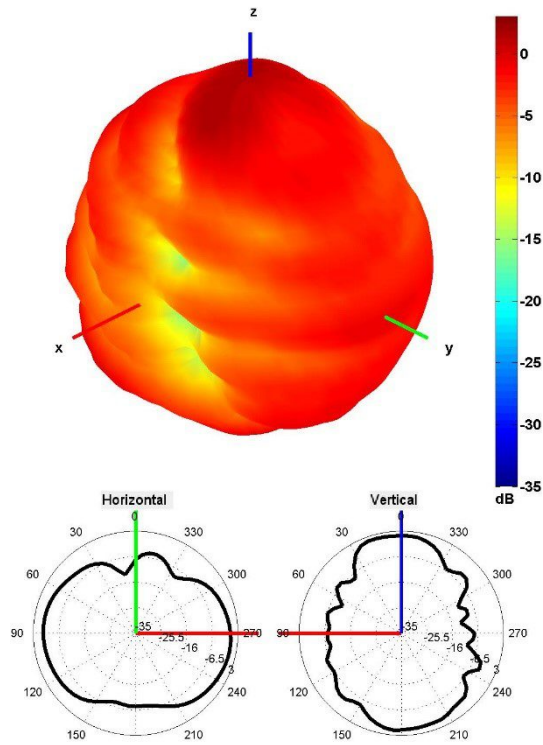

868 MHz Radiation pattern

4. Antenna drawings

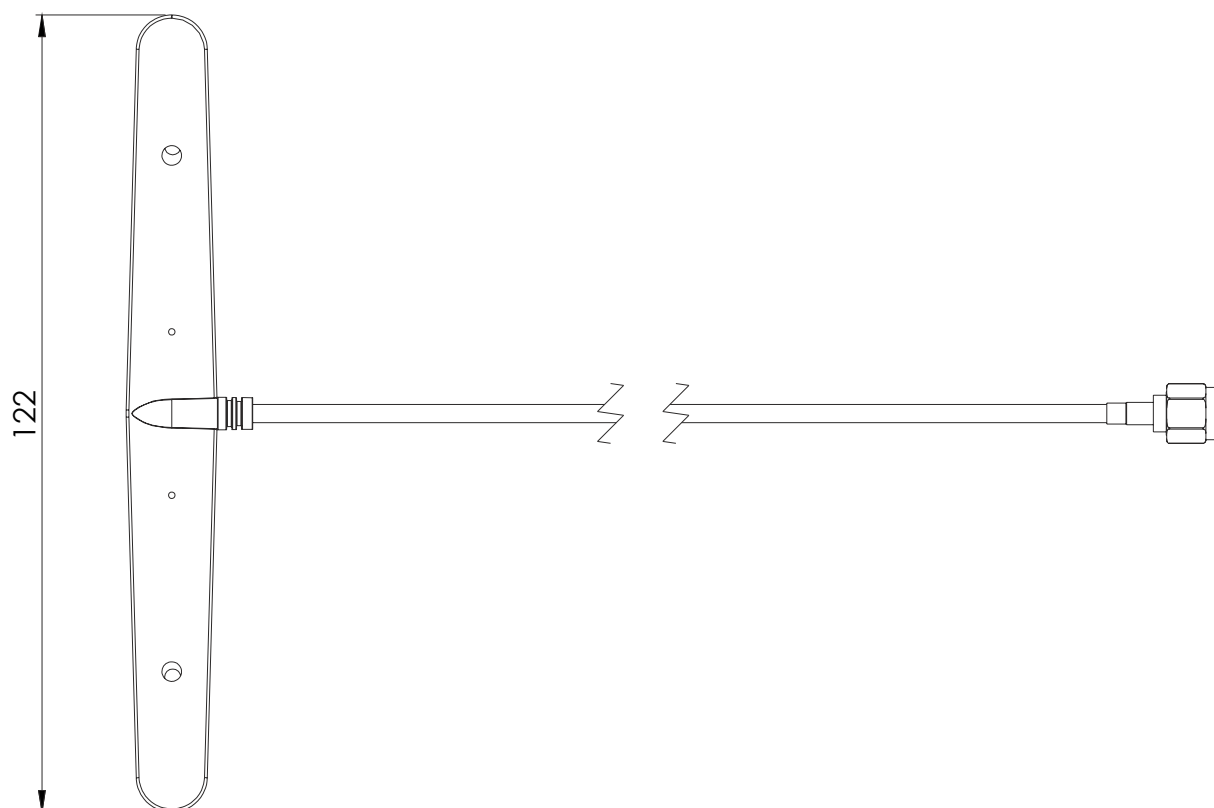
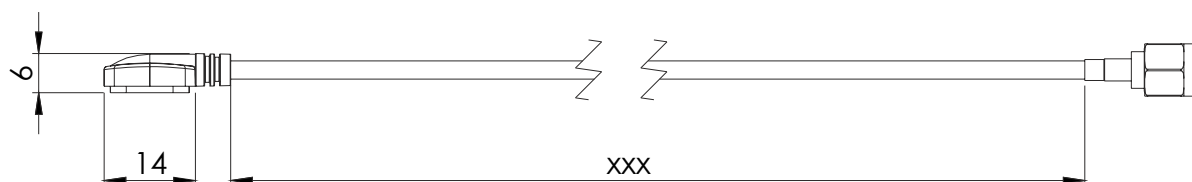

5. Antenna Images

