

## 2J4841PCF

CELLULAR/LTE and GPS/GLONASS Adhesive Mount

### Key Features

#### Cable 1: CELLULAR/LTE

- 698-960 MHz
- 1710-2170 MHz
- 2500-2700 MHz

#### Cable 2: GPS/GLONASS/BeiDou/QZSS/Galileo

- 1561-1606 MHz

Adhesive Mount

Ground Plane Independent

Customizable Cable and Connector

Dimensions 83 x 35 x 13.3 mm

Certificates: IP67, IP69



## 1. Antenna and electrical specifications

Cable 1

Parameters	CELLULAR/LTE Antenna		
<b>Standards</b>	2G,3G and 4G		
<b>Band (MHz)</b>	700/850/900	1700/1800/1900/2100	2600
<b>Frequency (MHz)</b>	698-960	1710-2170	2500-2700
<b>Return Loss (dB)</b>	~-13.3	~-18.3	~-9.8
<b>VSWR</b>	~1.8:1	~1.3:1	~2.0:1
<b>Efficiency (%)</b>	~53	~49	~25
<b>Peak Gain (dBi)</b>	~2.4	~1.3	~0.4
<b>Average Gain (dB)</b>	~-2.7	~-3.0	~-5.9
<b>Impedance (Ohm)</b>	50		
<b>Polarisation</b>	Linear		
<b>Radiation Pattern</b>	Omni-Directional		
<b>Max. Input Power (W)</b>	25		
<b>Connector Type</b>	SMA-Male Standard (Other Connectors Available)		
<b>Cable Length</b>	300 cm Standard (Any Cable Length Available)		
<b>Cable Type</b>	LMR100 Standard (Other Cables Available)		

Cable 2

Parameters	GPS/GLONASS/BeiDou Antenna		
<b>Standards</b>	BeiDou	GPS/QZSS/Galileo	GLONASS
<b>Band (MHz)</b>	1561	1575	1602
<b>Frequency(MHz)</b>	1561.098	1575.42	1598-1610
<b>Patch Size (mm)</b>	25 x 25 x 4		
<b>Return Loss (dB)</b>	<=-15.0 dB		
<b>VSWR</b>	<=1.4:1 dB		
<b>Impedance</b>	50		
<b>Radiation Pattern</b>	Hemispherical		
<b>Polarization</b>	RHCP		
<b>Saw Filter</b>	Pre-filter		
<b>Active Gain (dB)</b>	28 @ 2.7 V		
<b>Noise Figure (dB)</b>	1.5 Typ		
<b>Voltage (V)</b>	1.5 – 3.6		
<b>Current Consumption (mA)</b>	9 Typ		
<b>Power Consumption (mW)</b>	24.3 Typ		
<b>ESD Protection (kV)</b>	2kV		
<b>Connector Type</b>	SMA-Male Standard (Other Connectors Available)		
<b>Cable Length</b>	300 cm Standard (Any Cable Length Available)		
<b>Cable Type</b>	LMR100 Standard (Other Cables Available)		

**Antenna Measurement Conditions:**

Mounted on 30 x 30 x 0.25 cm ABS Plate

200 cm of Cable LMR100

Measured in Certified CTIA 3D Anechoic Chamber

## 2. Mechanical and environmental specifications

Specifications	2J4841PCF
<b>Mounting Type</b>	Adhesive Mount
<b>Dimensions (mm)</b>	83 x 35 x 13.3
<b>Radome</b>	ABS UV Stable
<b>Radome color</b>	Black
<b>Operating Temperature (C)</b>	-40 to +85
<b>Storage Temperature (C)</b>	-40 to +85
<b>Substance Compliance</b>	RoHS
<b>Certificates</b>	IP67, IP69

### 3. Antenna parameters

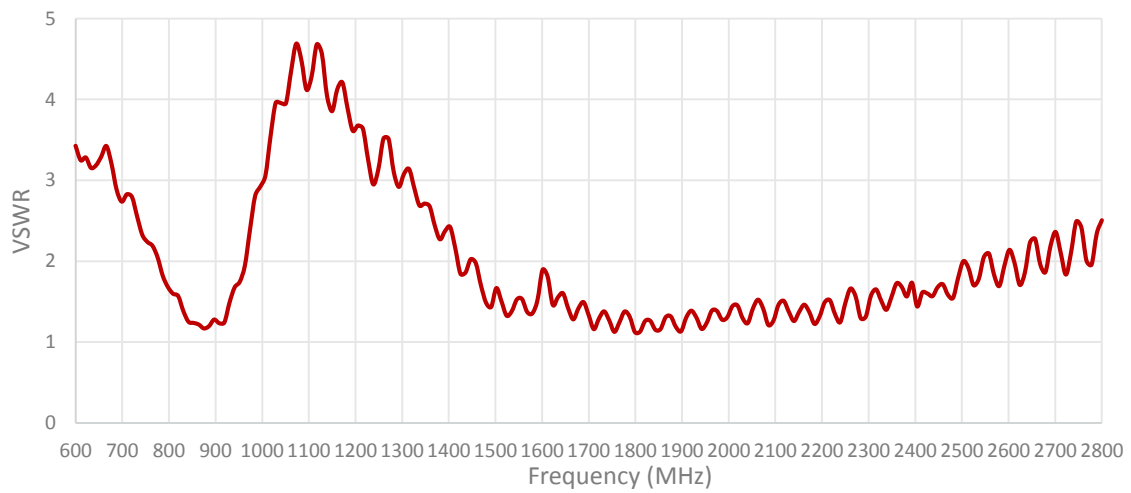
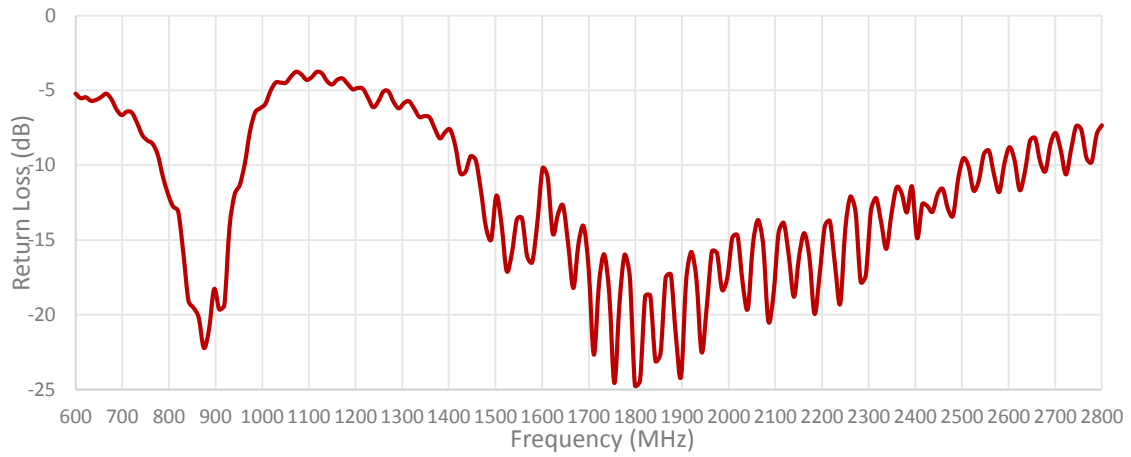

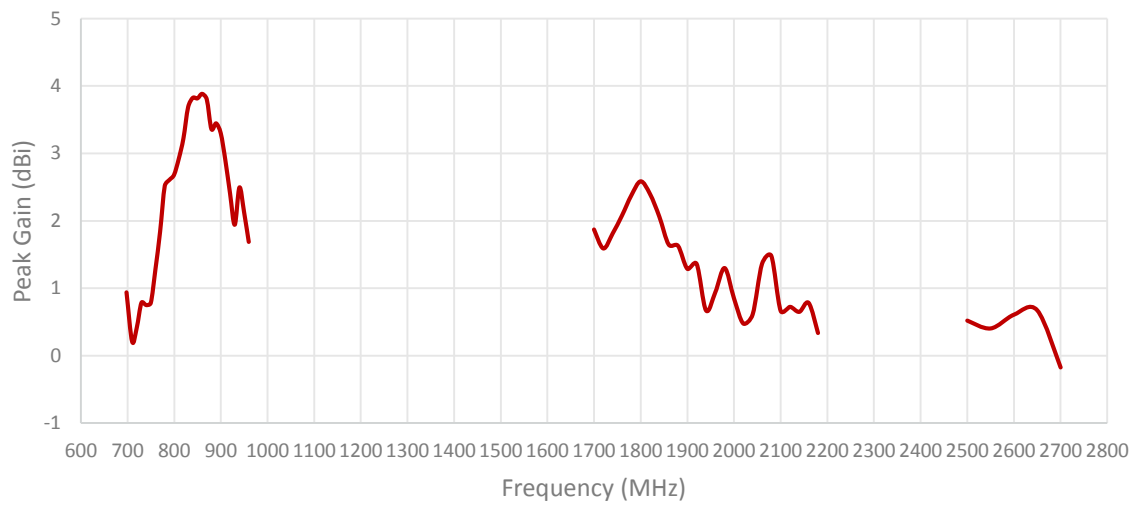
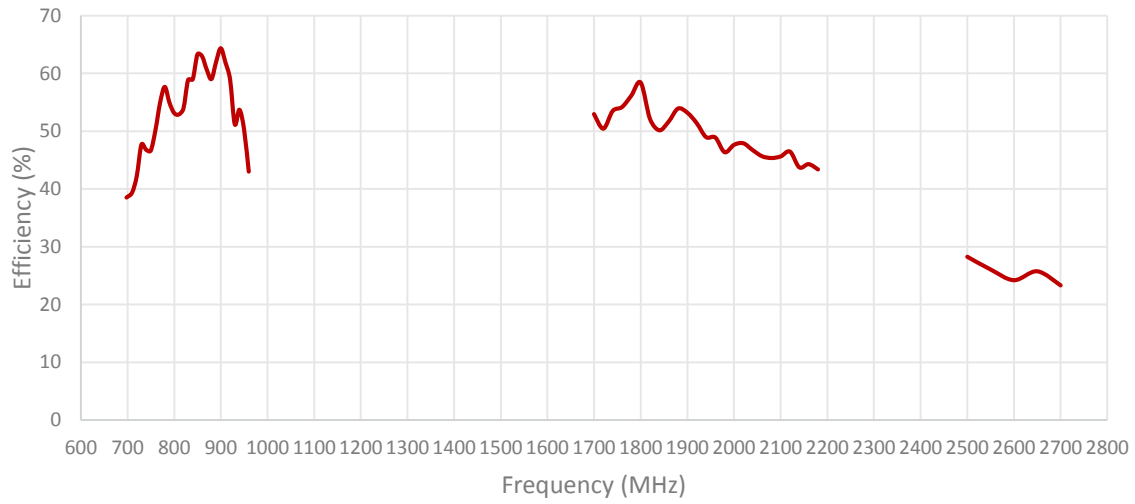

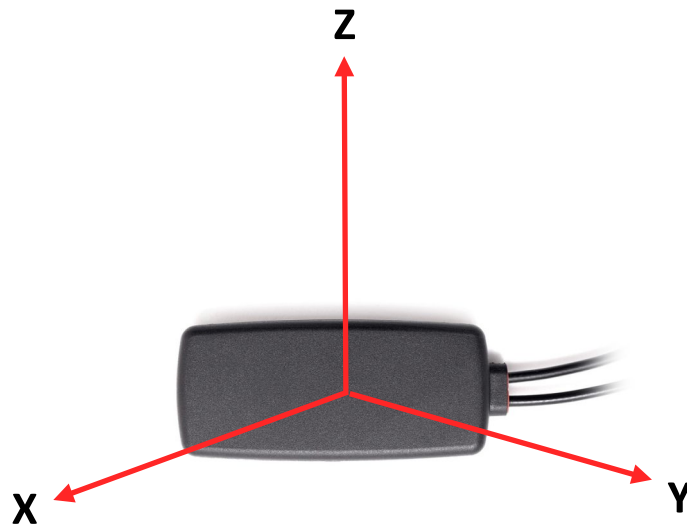
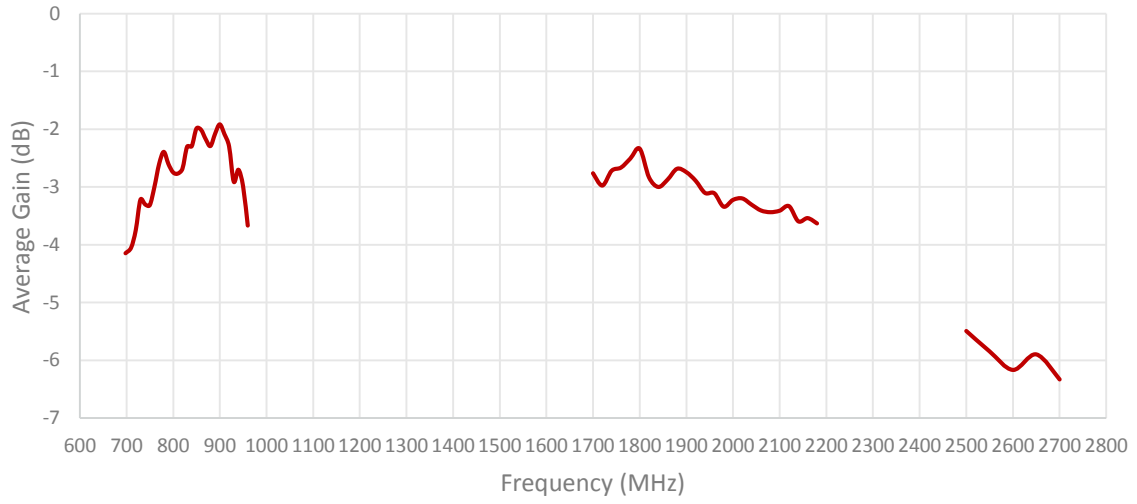

Radiation pattern reference

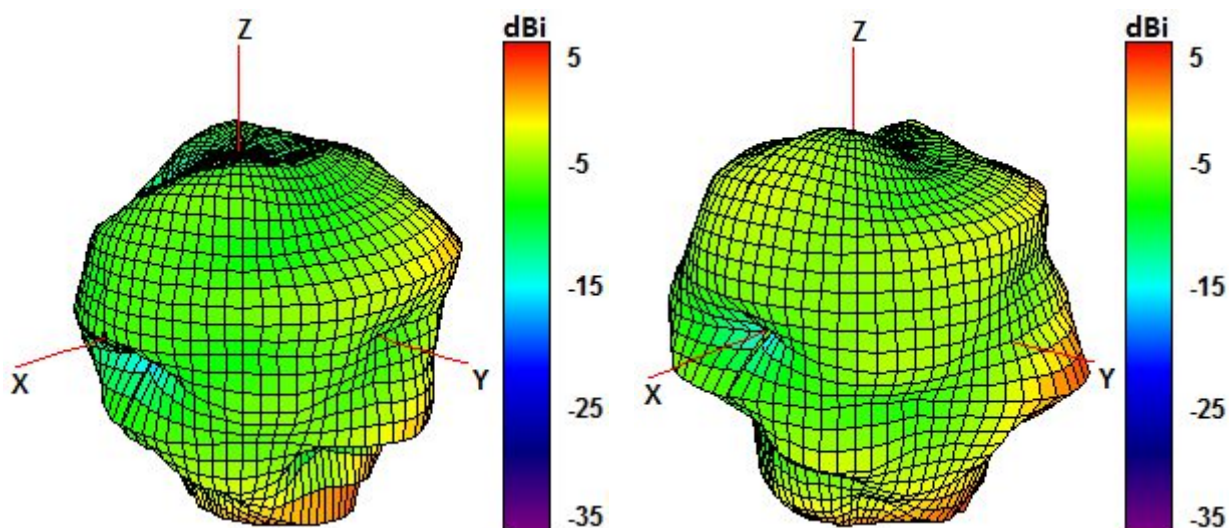

750 and 850 MHz Radiation pattern

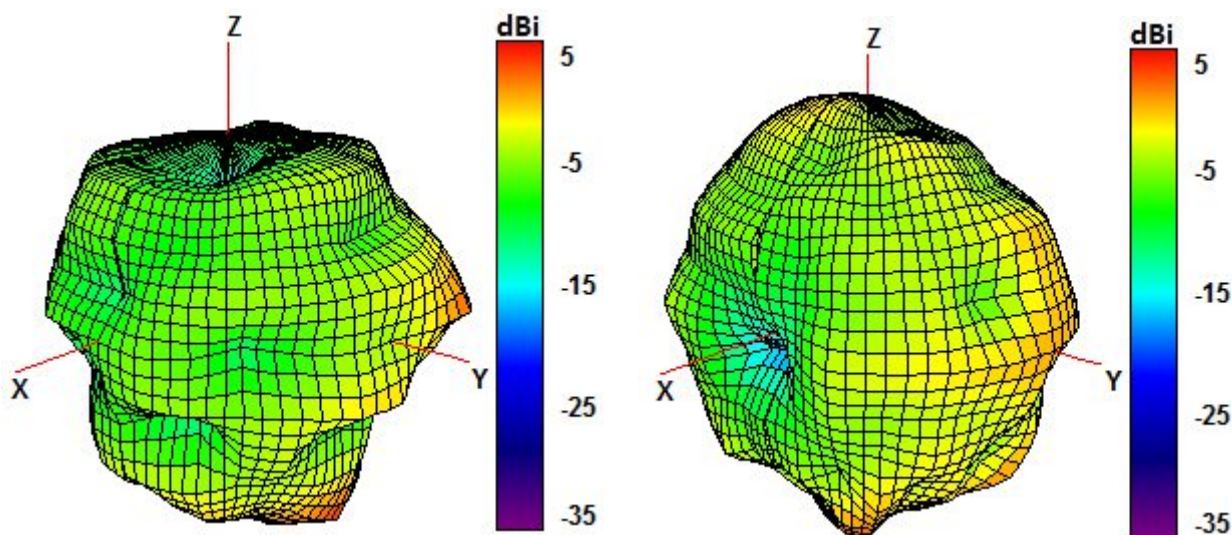

940 and 1750 MHz Radiation pattern

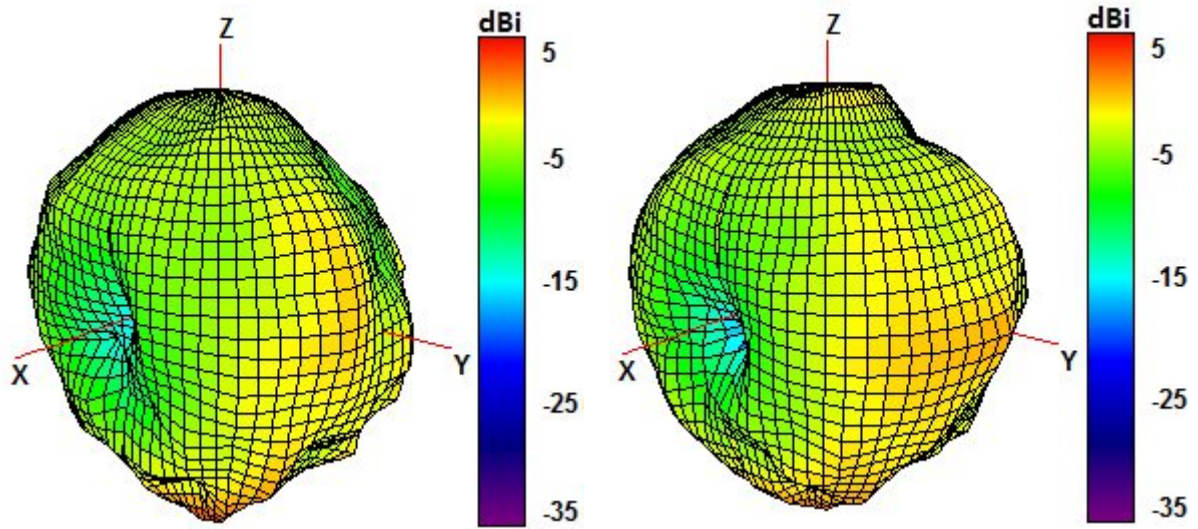

1850 and 1950 MHz Radiation pattern

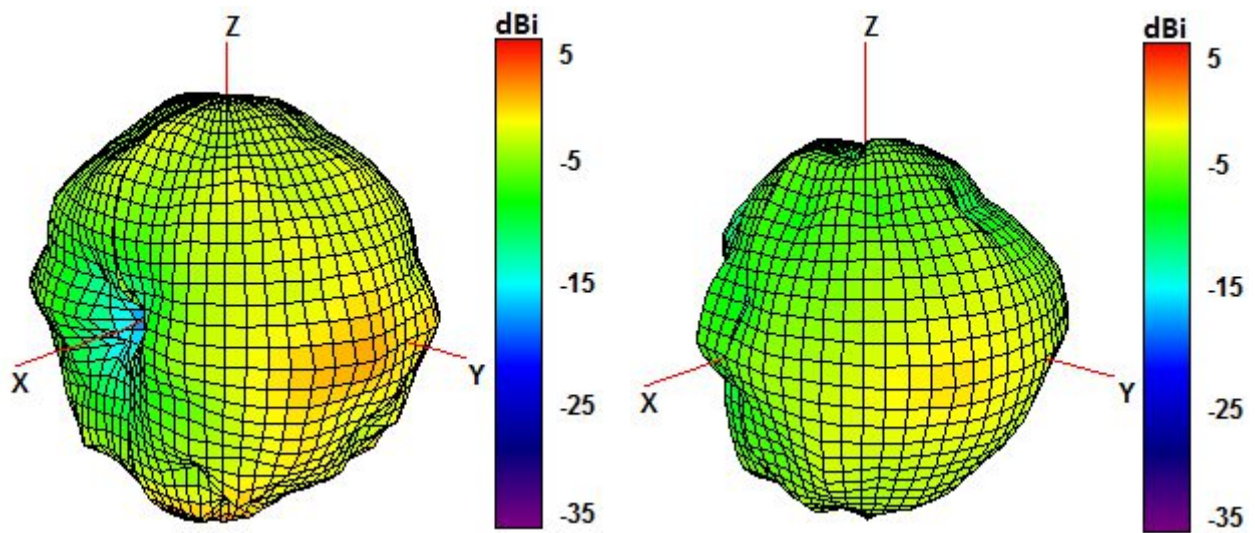

2100 and 2600 MHz Radiation pattern



## 4. Antenna drawings

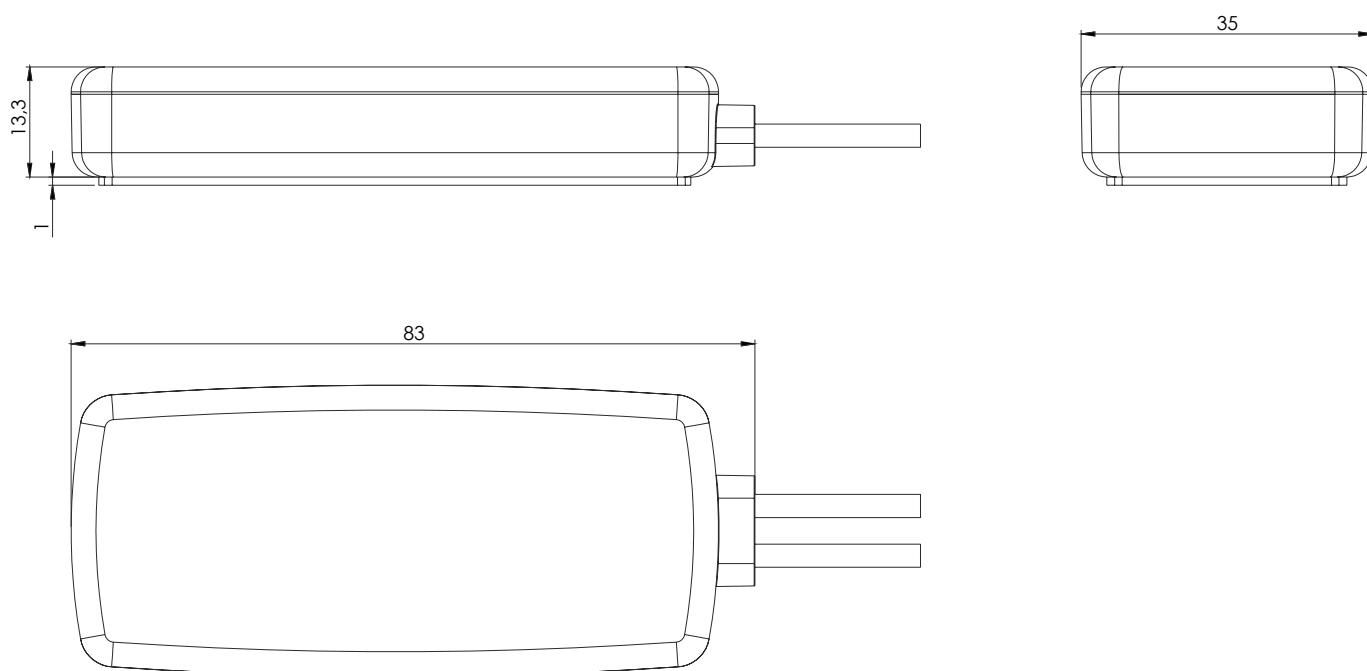

## 5. Antenna Images

