

2J0B15-915-C884G

915 MHz ISM Connector Mount

Key Features

915 MHz ISM
- 902-928 MHz
Connector Mount
Low Profile
Ground Plane Dependent
Dimensions 44 × 19.1 × 9 mm



1. Antenna Description

2J0B15-915-C884G

The High-Efficiency Antenna Optimized for ISM

This 2J0B15-915 connector mount low profile ground plane dependent antenna has been optimized specifically for the ISM frequency bands of 902MHz to 928MHz in the US market.

This antenna was developed for system installations such as industrial, scientific and medical applications. IoT applications can also take advantage of this system as it provides high throughput as it has no restrictions on the type of application or duty cycle. In addition, the power output permitted by the regulations is considerably higher than it is in other portions of the ISM spectrum allowing IoT implementations that can range from home automation, security, industrial control, remote sensing, automatic meter reading, toys, weather stations, among many other consumer applications.

Application Parameters

The 2J0B15-915 915MHz band antenna provides a stable connection through walls and transmission is not disturbed by obstacles such as human bodies (this is the case for WIFI and Bluetooth technologies at 2,4 GHz).

Typical applications

- IoT applications
- Remote Monitoring
- Smart Metering
- Home Automation
- Medical Devices
- M2M automation
- And others

Key Features

- ISM specifically optimized
- 12 variations with straight, right-angle and reversed polarity connectors
- Sustained High Efficiency and Performance
- High Gain
- Compact and Elegant
- Ground Plane Dependent
- Easy Integration
- Different colors available upon request

Installation

For specialized applications, this cable free antenna solution can be retrofitted with a straight or right-angle SMA-Male-R/A standard connector.

2. Antenna and electrical specifications

Parameters	915 MHz ISM Antenna
Standards	ZigBee, ISM, SIGFOX, LoRa
Band (MHz)	915 MHz
Frequency (MHz)	902-928
Return Loss (dB)	~-12.3
VSWR	~1.6:1
Efficiency (%)	~75
Peak Gain (dBi)	~3.0
Average Gain (dB)	~-1.3
Impedance (Ohm)	50
Polarisation	Linear
Radiation Pattern	Omni-Directional
Max. Input Power (W)	25
Connector Type	SMA-Male-R/A Standard

Antenna Measurement Conditions:

Mounted on Ground Plane of 95x40 mm

Measured in Certified CTIA 3D Anechoic Chamber

3. Mechanical and environmental specifications

Specifications	2J0B15-915-C884G
Mounting Type	Connector Mount
Dimensions (mm)	44 × 19.1 × 9
Radome	TPC-ET
Radome color	Black
Operating Temperature (C)	-40 to +85
Storage Temperature (C)	-40 to +85
Substance Compliance	RoHS

4. Antenna parameters

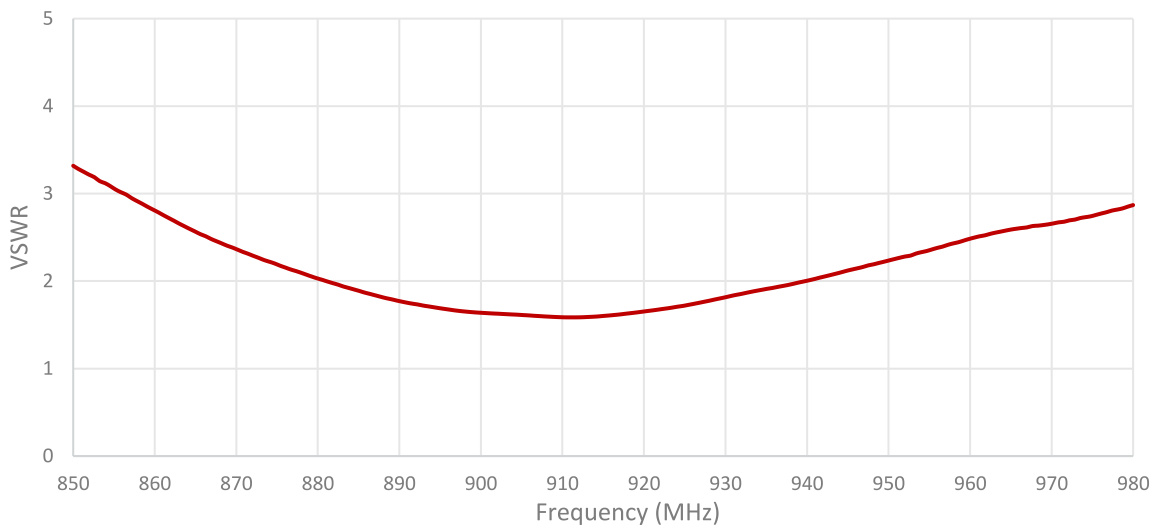
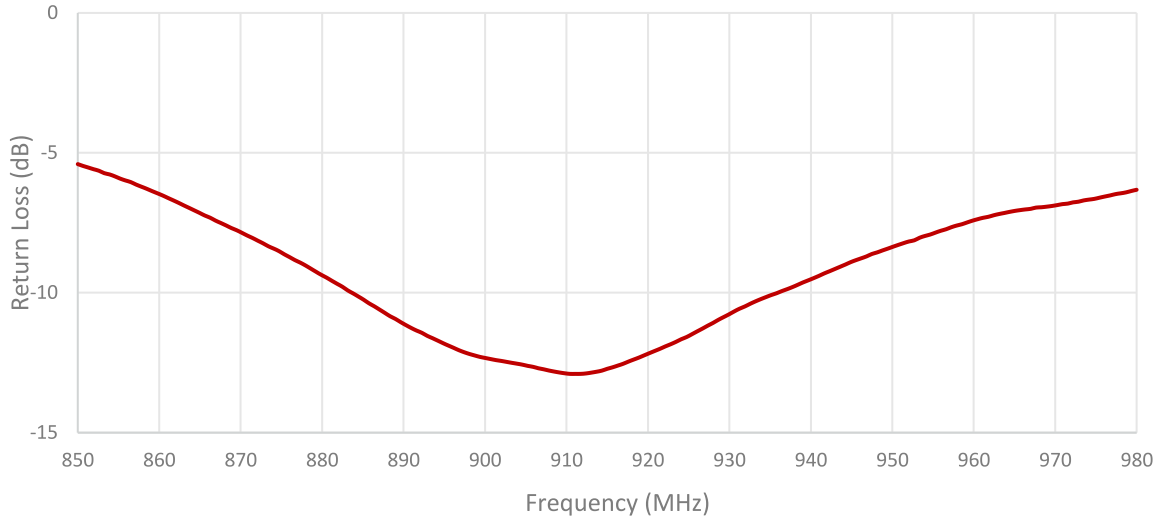

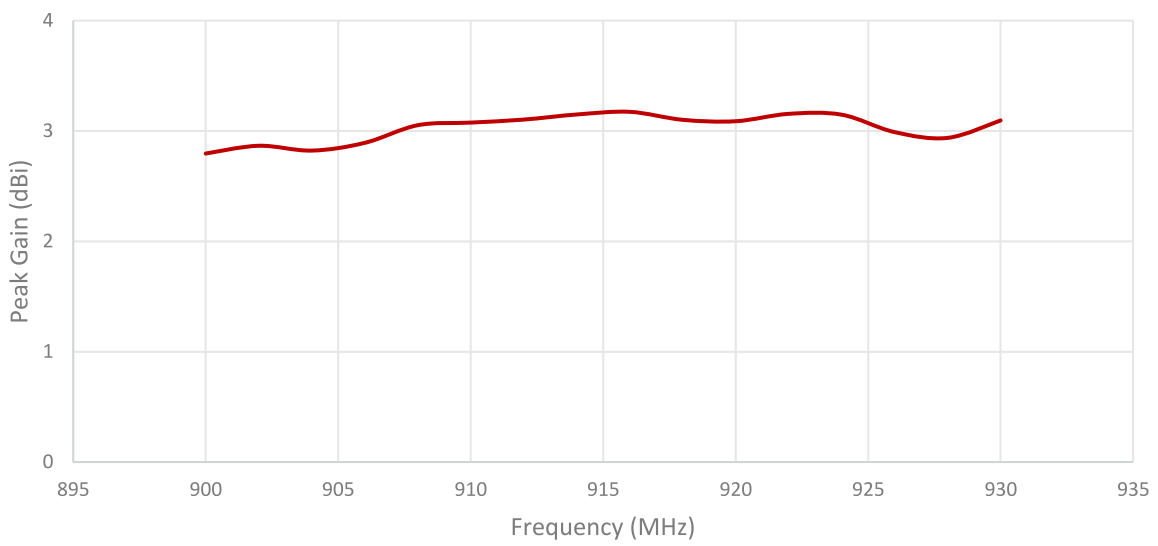
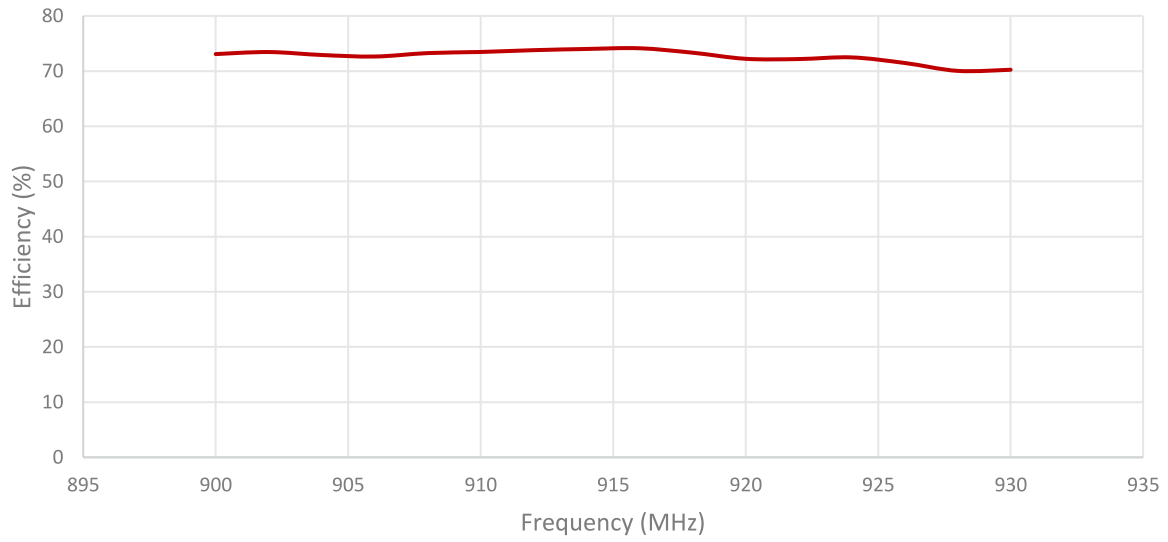

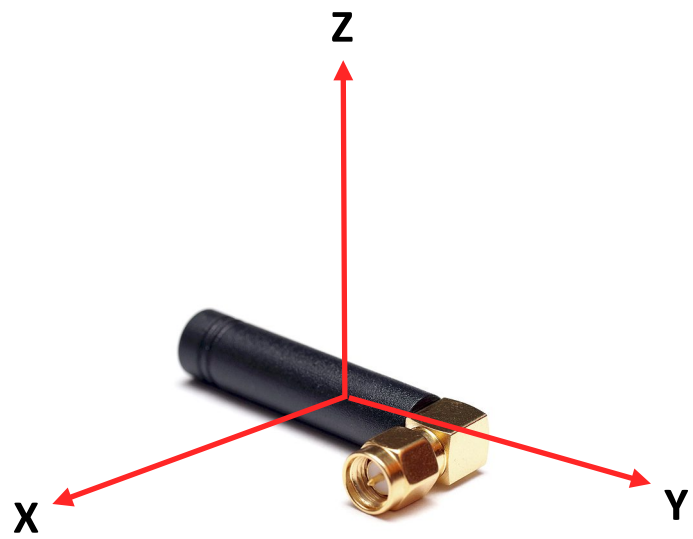
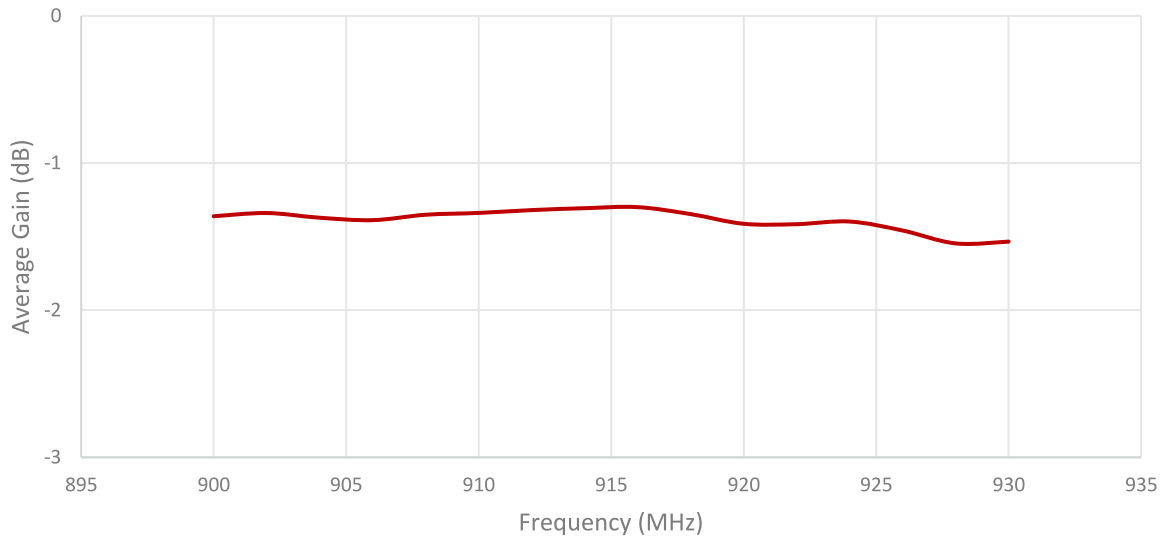

Radiation pattern reference

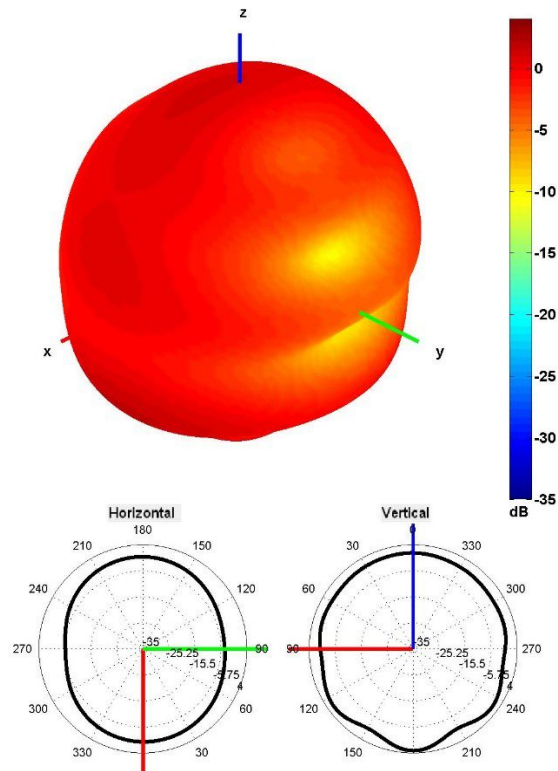

915 MHz Radiation pattern

5. Antenna drawings

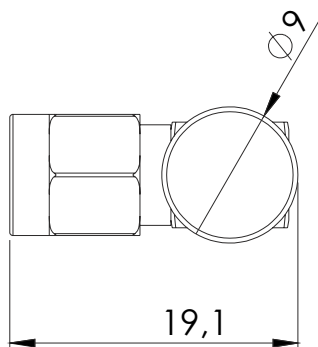
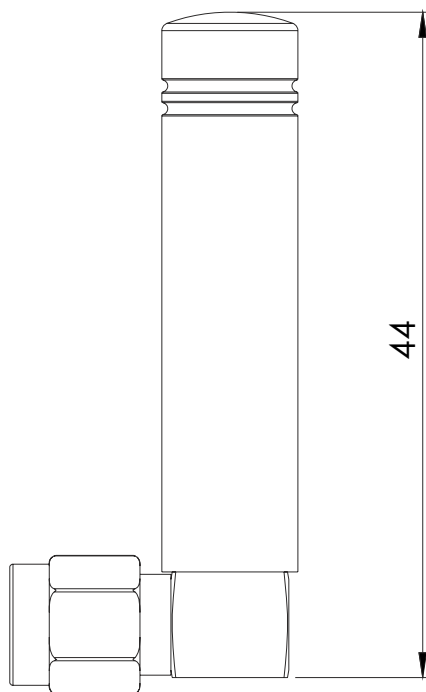

6. Antenna Images

